

MIL-DTL-83513 (M83513) 矩形(方型)微型連接器

MIL-DTL-83513涵蓋了超小型D型連接器用於在空間和重量限制的連接器。M83513矩形連接器輕巧堅固的外殼，可採複合塑料或航天級鋁合金。設計間距為1.27毫米（0.050英寸）使用24AWG接觸點（插針，）非常緊湊高密度的連結。

MIL-DTL-83513連接器是理想的軍事應用產品，如導彈；狹小空間應用，如衛星；商業航空電子設備和導航系統；醫療設備；機器人；和手持式測試設備。

MIL-DTL-83513連接器可用於焊接，印刷電路板或預接線連接器類型。當配合時，這些連接器是高度可靠的和耐環境由於特殊密封件和障礙併入它們的設計。

- 插入材料類型 - 液晶聚合物，聚酯或鄰苯二甲酸二烯丙酯
- 佈局 - 9到100個接點的各種配置
- 觸點類型 - 插針（插頭）/插座（插座）
- 端子 - 焊杯/印刷電路板（直，直角，窄輪廓）
- 硬件 - 螺紋，大型或標準通孔，浮動安裝，千斤頂，起重螺絲等。
- 修改 - 高溫版本，黑色陽極氧化，無電鍍鎳，鎳，酸性/氨基酸。

注：MIL-PRF-83513已由MIL-DTL-83513替代。

MIL-DTL-83513產品規格

Slant	Config.	Termination	Description
M83513/01	Plug	Solder cup	9-100 Contacts, metal shell connector
M83513/02	Receptacle	Solder cup	9-100 Contacts, metal shell connector
M83513/03	Plug	Pre-wired crimp	9-100 Contacts, metal shell connector
M83513/04	Receptacle	Pre-wired crimp	9-100 Contacts, metal shell connector
M83513/05	Jackpost / jackscrew	n/a	Jackpost & jackscrew kits
M83513/06	Plug	Solder cup	9-51 Contacts, plastic shell connector
M83513/07	Receptacle	Solder cup	9-51 Contacts, plastic shell connector
M83513/08	Plug	Pre-wired crimp	9-51 Contacts, plastic shell connector
M83513/09	Receptacle	Pre-wired crimp	9-51 Contacts, plastic shell connector
M83513/10	Plug	Condensed right angle PCB	9-37 Contacts, various shell finishes
M83513/11	Plug	Condensed right angle PCB	51 Contacts, various shell finishes
M83513/12	Plug	Condensed right angle PCB	100 Contacts, various shell finishes
M83513/13	Receptacle	Condensed right angle PCB	9-37 Contacts, various shell finishes
M83513/14	Receptacle	Condensed right angle PCB	51 Contacts, various shell finishes
M83513/15	Receptacle	Condensed right angle PCB	100 Contacts, various shell finishes
M83513/16	Plug	Right angle PCB	9-37 Contacts, various shell finishes
M83513/17	Plug	Right angle PCB	51 Contacts, various shell finishes



佳昭企業有限公司
NEARSON ENTERPRISE CORP.

• TEL:886-2-2957-9823 • FAX:886-2-2957-9712
• <http://www.nearson.com.tw>

M83513/18	Plug	Right angle PCB	100 Contacts, various shell finishes
M83513/19	Receptacle	Right angle PCB	9-37 Contacts, various shell finishes
M83513/20	Receptacle	Right angle PCB	51 Contacts, various shell finishes
M83513/21	Receptacle	Right angle PCB	100 Contacts, various shell finishes
M83513/22	Plug	Straight PCB	9-37 Contacts, various shell finishes
M83513/23	Plug	Straight PCB	51 Contacts, various shell finishes
M83513/24	Plug	Straight PCB	100 Contacts, various shell finishes
M83513/25	Receptacle	Straight PCB	9-37 Contacts, various shell finishes
M83513/26	Receptacle	Straight PCB	51 Contacts, various shell finishes
M83513/27	Receptacle	Straight PCB	100 Contacts, various shell finishes
M83513/28	Plug	Condensed straight PCB	9-37 Contacts, various shell finishes
M83513/29	Plug	Condensed straight PCB	51 Contacts, various shell finishes
M83513/30	Plug	Condensed straight PCB	100 Contacts, various shell finishes
M83513/31	Receptacle	Condensed straight PCB	9-37 Contacts, various shell finishes
M83513/32	Receptacle	Condensed straight PCB	51 Contacts, various shell finishes
M83513/33	Receptacle	Condensed straight PCB	100 Contacts, various shell finishes

AXON 公司生產全系列之軍規 Micro-D 產品，如下頁，採用 AXON 產品系列肯定是最佳的選擇。
M83513/5 為螺絲配件，AXON 亦完全提供本系列產品，如何選配請洽佳昭公司。



佳昭企業有限公司
NEARSON ENTERPRISE CORP.

• TEL:886-2-2957-9823 • FAX:886-2-2957-9712
• <http://www.nearson.com.tw>

MILITARY CROSS REFERENCE CHART

M83513/01

MIL STANDARD	AXON' EQUIVALENT	MIL STANDARD	AXON' EQUIVALENT	MIL STANDARD	AXON' EQUIVALENT
M83513/01-AC	MDA109PFSB	M83513/01-DC	MDA125PFSB	M83513/01-GC	MDA151PFSB
M83513/01-AN	MDA209PFSB	M83513/01-DN	MDA225PFSB	M83513/01-GN	MDA251PFSB
M83513/01-AP	MDAS09PFSB	M83513/01-DP	MDAS25PFSB	M83513/01-GP	MDAS51PFSB
M83513/01-BC	MDA115PFSB	M83513/01-EC	MDA131PFSB	M83513/01-HC	MDA1100PFSB
M83513/01-BN	MDA215PFSB	M83513/01-EN	MDA231PFSB	M83513/01-HN	MDA2100PFSB
M83513/01-BP	MDAS15PFSB	M83513/01-EP	MDAS31PFSB	M83513/01-HP	MDAS100PFSB
M83513/01-CC	MDA121PFSB	M83513/01-FC	MDA137PFSB		
M83513/01-CN	MDA221PFSB	M83513/01-FN	MDA237PFSB		
M83513/01-CP	MDAS21PFSB	M83513/01-FP	MDAS37PFSB		

M83513/02

MIL STANDARD	AXON' EQUIVALENT	MIL STANDARD	AXON' EQUIVALENT	MIL STANDARD	AXON' EQUIVALENT
M83513/02-AC	MDA109SFSB	M83513/02-CP	MDAS21SFSB	M83513/02-FN	MDA237SFSB
M83513/02-AN	MDA209SFSB	M83513/02-DC	MDA125SFSB	M83513/02-FP	MDAS37SFSB
M83513/02-AP	MDAS09SFSB	M83513/02-DN	MDA225SFSB	M83513/02-GC	MDA151SFSB
M83513/02-BC	MDA115SFSB	M83513/02-DP	MDAS25SFSB	M83513/02-GN	MDA251SFSB
M83513/02-BN	MDA215SFSB	M83513/02-EC	MDA131SFSB	M83513/02-GP	MDAS51SFSB
M83513/02-BP	MDAS15SFSB	M83513/02-EN	MDA231SFSB	M83513/02-HC	MDA1100SFSB
M83513/02-CC	MDA121SFSB	M83513/02-EP	MDAS31SFSB	M83513/02-HN	MDA2100SFSB
M83513/02-CN	MDA221SFSB	M83513/02-FC	MDA137SFSB	M83513/02-HP	MDAS100SFSB

M83513/03

MIL STANDARD	AXON' EQUIVALENT	MIL STANDARD	AXON' EQUIVALENT	MIL STANDARD	AXON' EQUIVALENT
M83513/03-A01C	MDA109P4L046B	M83513/03-A09N	MDA209PEL046B	M83513/03-B01C	MDA115P4L046B
M83513/03-A01N	MDA209P4L046B	M83513/03-A09P	MDAS09PEL046B	M83513/03-B01N	MDA215P4L046B
M83513/03-A01P	MDAS09P4L046B	M83513/03-A10C	MDA109PEL092B	M83513/03-B01P	MDAS15P4L046B
M83513/03-A02C	MDA109P4L092B	M83513/03-A10N	MDA209PEL092B	M83513/03-B02C	MDA115P4L092B
M83513/03-A02N	MDA209P4L092B	M83513/03-A10P	MDAS09PEL092B	M83513/03-B02N	MDA215P4L092B
M83513/03-A02P	MDAS09P4L092B	M83513/03-A11C	MDA109PEW046B	M83513/03-B02P	MDAS15P4L092B
M83513/03-A03C	MDA109P4W046B	M83513/03-A11N	MDA209PEW046B	M83513/03-B03C	MDA115P4W046B
M83513/03-A03N	MDA209P4W046B	M83513/03-A11P	MDAS09PEW046B	M83513/03-B03N	MDA215P4W046B
M83513/03-A03P	MDAS09P4W046B	M83513/03-A12C	MDA109PEW092B	M83513/03-B03P	MDAS15P4W046B
M83513/03-A04C	MDA109P4W092B	M83513/03-A12N	MDA209PEW092B	M83513/03-B04C	MDA115P4W092B
M83513/03-A04N	MDA209P4W092B	M83513/03-A12P	MDAS09PEW092B	M83513/03-B04N	MDA215P4W092B
M83513/03-A04P	MDAS09P4W092B	M83513/03-A13C	MDA109P4L183B	M83513/03-B04P	MDAS15P4W092B
M83513/03-A05C	MDA109PG002B	M83513/03-A13N	MDA209P4L183B	M83513/03-B05C	MDA115PG002B
M83513/03-A05N	MDA209PG002B	M83513/03-A13P	MDAS09P4L183B	M83513/03-B05N	MDA215PG002B
M83513/03-A05P	MDAS09PG002B	M83513/03-A14C	MDA109P4W183B	M83513/03-B05P	MDAS15PG002B
M83513/03-A06C	MDA109PG003B	M83513/03-A14N	MDA209P4W183B	M83513/03-B06C	MDA115PG003B
M83513/03-A06N	MDA209PG003B	M83513/03-A14P	MDAS09P4W183B	M83513/03-B06N	MDA215PG003B
M83513/03-A06P	MDAS09PG003B	M83513/03-A15C	MDA109PEL183B	M83513/03-B06P	MDAS15PG003B
M83513/03-A07C	MDA109PT002B	M83513/03-A15N	MDA209PEL183B	M83513/03-B07C	MDA115PT002B
M83513/03-A07N	MDA209PT002B	M83513/03-A15P	MDAS09PEL183B	M83513/03-B07N	MDA215PT002B
M83513/03-A07P	MDAS09PT002B	M83513/03-A16C	MDA109PEW183B	M83513/03-B07P	MDAS15PT002B
M83513/03-A08C	MDA109PT003B	M83513/03-A16N	MDA209PEW183B	M83513/03-B08C	MDA115PT003B
M83513/03-A08N	MDA209PT003B	M83513/03-A16P	MDAS09PEW183B	M83513/03-B08N	MDA215PT003B
M83513/03-A08P	MDAS09PT003B			M83513/03-B08P	MDAS15PT003B
M83513/03-A09C	MDA109PEL046B			M83513/03-B09C	MDA115PEL046B

M83513/03 (continued)

MIL-DTL-83513
CONNECTORS

Rectangular
Micro-D connectors

MIL STANDARD	AXON' EQUIVALENT	MIL STANDARD	AXON' EQUIVALENT	MIL STANDARD	AXON' EQUIVALENT
M83513/03-B09N	MDA215PEL046B	M83513/03-C12N	MDA221PEW092B	M83513/03-D15N	MDA225PEL183B
M83513/03-B09P	MDAS15PEL046B	M83513/03-C12P	MDAS21PEW092B	M83513/03-D15P	MDAS25PEL183B
M83513/03-B10C	MDA115PEL092B	M83513/03-C13C	MDA121P4L183B	M83513/03-D16C	MDA125PEW183B
M83513/03-B10N	MDA215PEL092B	M83513/03-C13N	MDA221P4L183B	M83513/03-D16N	MDA225PEW183B
M83513/03-B10P	MDAS15PEL092B	M83513/03-C13P	MDAS21P4L183B	M83513/03-D16P	MDAS25PEW183B
M83513/03-B11C	MDA115PEW046B	M83513/03-C14C	MDA121P4W183B	M83513/03-E01C	MDA131P4L046B
M83513/03-B11N	MDA215PEW046B	M83513/03-C14N	MDA221P4W183B	M83513/03-E01N	MDA231P4L046B
M83513/03-B11P	MDAS15PEW046B	M83513/03-C14P	MDAS21P4W183B	M83513/03-E01P	MDAS31P4L046B
M83513/03-B12C	MDA115PEW092B	M83513/03-C15C	MDA121PEL183B	M83513/03-E02C	MDA131P4L092B
M83513/03-B12N	MDA215PEW092B	M83513/03-C15N	MDA221PEL183B	M83513/03-E02N	MDA231P4L092B
M83513/03-B12P	MDAS15PEW092B	M83513/03-C15P	MDAS21PEL183B	M83513/03-E02P	MDAS31P4L092B
M83513/03-B13C	MDA115P4L183B	M83513/03-C16C	MDA121PEW183B	M83513/03-E03C	MDA131P4W046B
M83513/03-B13N	MDA215P4L183B	M83513/03-C16N	MDA221PEW183B	M83513/03-E03N	MDA231P4W046B
M83513/03-B13P	MDAS15P4L183B	M83513/03-C16P	MDAS21PEW183B	M83513/03-E03P	MDAS31P4W046B
M83513/03-B14C	MDA115P4W183B	M83513/03-D01C	MDA125P4L046B	M83513/03-E04C	MDA131P4W092B
M83513/03-B14N	MDA215P4W183B	M83513/03-D01N	MDA225P4L046B	M83513/03-E04N	MDA231P4W092B
M83513/03-B14P	MDAS15P4W183B	M83513/03-D01P	MDAS25P4L046B	M83513/03-E04P	MDAS31P4W092B
M83513/03-B15C	MDA115PEL183B	M83513/03-D02C	MDA125P4L092B	M83513/03-E05C	MDA131PG002B
M83513/03-B15N	MDA215PEL183B	M83513/03-D02N	MDA225P4L092B	M83513/03-E05N	MDA231PG002B
M83513/03-B15P	MDAS15PEL183B	M83513/03-D02P	MDAS25P4L092B	M83513/03-E05P	MDAS31PG002B
M83513/03-B16C	MDA115PEW183B	M83513/03-D03C	MDA125P4W046B	M83513/03-E06C	MDA131PG003B
M83513/03-B16N	MDA215PEW183B	M83513/03-D03N	MDA225P4W046B	M83513/03-E06N	MDA231PG003B
M83513/03-B16P	MDAS15PEW183B	M83513/03-D03P	MDAS25P4W046B	M83513/03-E06P	MDAS31PG003B
M83513/03-C01C	MDA121P4L046B	M83513/03-D04C	MDA125P4W092B	M83513/03-E07C	MDA131PT002B
M83513/03-C01N	MDA221P4L046B	M83513/03-D04N	MDA225P4W092B	M83513/03-E07N	MDA231PT002B
M83513/03-C01P	MDAS21P4L046B	M83513/03-D04P	MDAS25P4W092B	M83513/03-E07P	MDAS31PT002B
M83513/03-C02C	MDA121P4L092B	M83513/03-D05C	MDA125PG002B	M83513/03-E08C	MDA131PT003B
M83513/03-C02N	MDA221P4L092B	M83513/03-D05N	MDA225PG002B	M83513/03-E08N	MDA231PT003B
M83513/03-C02P	MDAS21P4L092B	M83513/03-D05P	MDAS25PG002B	M83513/03-E08P	MDAS31PT003B
M83513/03-C03C	MDA121P4W046B	M83513/03-D06C	MDA125PG003B	M83513/03-E09C	MDA131PEL046B
M83513/03-C03N	MDA221P4W046B	M83513/03-D06N	MDA225PG003B	M83513/03-E09N	MDA231PEL046B
M83513/03-C03P	MDAS21P4W046B	M83513/03-D06P	MDAS25PG003B	M83513/03-E09P	MDAS31PEL046B
M83513/03-C04C	MDA121P4W092B	M83513/03-D07C	MDA125PT002B	M83513/03-E10C	MDA131PEL092B
M83513/03-C04N	MDA221P4W092B	M83513/03-D07N	MDA225PT002B	M83513/03-E10N	MDA231PEL092B
M83513/03-C04P	MDAS21P4W092B	M83513/03-D07P	MDAS25PT002B	M83513/03-E10P	MDAS31PEL092B
M83513/03-C05C	MDA121PG002B	M83513/03-D08C	MDA125PT003B	M83513/03-E11C	MDA131PEW046B
M83513/03-C05N	MDA221PG002B	M83513/03-D08N	MDA225PT003B	M83513/03-E11N	MDA231PEW046B
M83513/03-C05P	MDAS21PG002B	M83513/03-D08P	MDAS25PT003B	M83513/03-E11P	MDAS31PEW046B
M83513/03-C06C	MDA121PG003B	M83513/03-D09C	MDA125PEL046B	M83513/03-E12C	MDA131PEW092B
M83513/03-C06N	MDA221PG003B	M83513/03-D09N	MDA225PEL046B	M83513/03-E12N	MDA231PEW092B
M83513/03-C06P	MDAS21PG003B	M83513/03-D09P	MDAS25PEL046B	M83513/03-E12P	MDAS31PEW092B
M83513/03-C07C	MDA121PT002B	M83513/03-D10C	MDA125PEL092B	M83513/03-E13C	MDA131P4L183B
M83513/03-C07N	MDA221PT002B	M83513/03-D10N	MDA225PEL092B	M83513/03-E13N	MDA231P4L183B
M83513/03-C07P	MDAS21PT002B	M83513/03-D10P	MDAS25PEL092B	M83513/03-E13P	MDAS31P4L183B
M83513/03-C08C	MDA121PT003B	M83513/03-D11C	MDA125PEW046B	M83513/03-E14C	MDA131P4W183B
M83513/03-C08N	MDA221PT003B	M83513/03-D11N	MDA225PEW046B	M83513/03-E14N	MDA231P4W183B
M83513/03-C08P	MDAS21PT003B	M83513/03-D11P	MDAS25PEW046B	M83513/03-E14P	MDAS31P4W183B
M83513/03-C09C	MDA121PEL046B	M83513/03-D12C	MDA125PEW092B	M83513/03-E15C	MDA131PEL183B
M83513/03-C09N	MDA221PEL046B	M83513/03-D12N	MDA225PEW092B	M83513/03-E15N	MDA231PEL183B
M83513/03-C09P	MDAS21PEL046B	M83513/03-D12P	MDAS25PEW092B	M83513/03-E15P	MDAS31PEL183B
M83513/03-C10C	MDA121PEL092B	M83513/03-D13C	MDA125P4L183B	M83513/03-E16C	MDA131PEW183B
M83513/03-C10N	MDA221PEL092B	M83513/03-D13N	MDA225P4L183B	M83513/03-E16N	MDA231PEW183B
M83513/03-C10P	MDAS21PEL092B	M83513/03-D13P	MDAS25P4L183B	M83513/03-E16P	MDAS31PEW183B
M83513/03-C11C	MDA121PEW046B	M83513/03-D14C	MDA125P4W183B	M83513/03-F01C	MDA137P4L046B
M83513/03-C11N	MDA221PEW046B	M83513/03-D14N	MDA225P4W183B	M83513/03-F01N	MDA237P4L046B
M83513/03-C11P	MDAS21PEW046B	M83513/03-D14P	MDAS25P4W183B	M83513/03-F01P	MDAS37P4L046B
M83513/03-C12C	MDA121PEW092B	M83513/03-D15C	MDA125PEL183B	M83513/03-F02C	MDA137P4L092B

M83513/03 (continued)

MIL STANDARD	AXON' EQUIVALENT	MIL STANDARD	AXON' EQUIVALENT	MIL STANDARD	AXON' EQUIVALENT
M83513/03-F02N	MDA237P4L092B	M83513/03-G04P	MDAS51P4W092B	M83513/03-H07C	MDA1100PT002B
M83513/03-F02P	MDAS37P4L092B	M83513/03-G05C	MDA151PG002B	M83513/03-H07N	MDA2100PT002B
M83513/03-F03C	MDA137P4W046B	M83513/03-G05N	MDA251PG002B	M83513/03-H07P	MDAS100PT002B
M83513/03-F03N	MDA237P4W046B	M83513/03-G05P	MDAS51PG002B	M83513/03-H08C	MDA1100PT003B
M83513/03-F03P	MDAS37P4W046B	M83513/03-G06C	MDA151PG003B	M83513/03-H08N	MDA2100PT003B
M83513/03-F04C	MDA137P4W092B	M83513/03-G06N	MDA251PG003B	M83513/03-H08P	MDAS100PT003B
M83513/03-F04N	MDA237P4W092B	M83513/03-G06P	MDAS51PG003B	M83513/03-H09C	MDA1100PEL046B
M83513/03-F04P	MDAS37P4W092B	M83513/03-G07C	MDA151PT002B	M83513/03-H09N	MDA2100PEL046B
M83513/03-F05C	MDA137PG002B	M83513/03-G07N	MDA251PT002B	M83513/03-H09P	MDAS100PEL046B
M83513/03-F05N	MDA237PG002B	M83513/03-G07P	MDAS51PT002B	M83513/03-H10C	MDA1100PEL092B
M83513/03-F05P	MDAS37PG002B	M83513/03-G08C	MDA151PT003B	M83513/03-H10N	MDA2100PEL092B
M83513/03-F06C	MDA137PG003B	M83513/03-G08N	MDA251PT003B	M83513/03-H10P	MDAS100PEL092B
M83513/03-F06N	MDA237PG003B	M83513/03-G08P	MDAS51PT003B	M83513/03-H11C	MDA1100PEW046B
M83513/03-F06P	MDAS37PG003B	M83513/03-G09C	MDA151PEL046B	M83513/03-H11N	MDA2100PEW046B
M83513/03-F07C	MDA137PT002B	M83513/03-G09N	MDA251PEL046B	M83513/03-H11P	MDAS100PEW046B
M83513/03-F07N	MDA237PT002B	M83513/03-G09P	MDAS51PEL046B	M83513/03-H12C	MDA1100PEW092B
M83513/03-F07P	MDAS37PT002B	M83513/03-G10C	MDA151PEL092B	M83513/03-H12N	MDA2100PEW092B
M83513/03-F08C	MDA137PT003B	M83513/03-G10N	MDA251PEL092B	M83513/03-H12P	MDAS100PEW092B
M83513/03-F08N	MDA237PT003B	M83513/03-G10P	MDAS51PEL092B	M83513/03-H13C	MDA1100P4L183B
M83513/03-F08P	MDAS37PT003B	M83513/03-G11C	MDA151PEW046B	M83513/03-H13N	MDA2100P4L183B
M83513/03-F09C	MDA137PEL046B	M83513/03-G11N	MDA251PEW046B	M83513/03-H13P	MDAS100P4L183B
M83513/03-F09N	MDA237PEL046B	M83513/03-G11P	MDAS51PEW046B	M83513/03-H14C	MDA1100P4W183B
M83513/03-F09P	MDAS37PEL046B	M83513/03-G12C	MDA151PEW092B	M83513/03-H14N	MDA2100P4W183B
M83513/03-F10C	MDA137PEL092B	M83513/03-G12N	MDA251PEW092B	M83513/03-H14P	MDAS100P4W183B
M83513/03-F10N	MDA237PEL092B	M83513/03-G12P	MDAS51PEW092B	M83513/03-H15C	MDA1100PEL183B
M83513/03-F10P	MDAS37PEL092B	M83513/03-G13C	MDA151P4L183B	M83513/03-H15N	MDA2100PEL183B
M83513/03-F11C	MDA137PEW046B	M83513/03-G13N	MDA251P4L183B	M83513/03-H15P	MDAS100PEL183B
M83513/03-F11N	MDA237PEW046B	M83513/03-G13P	MDAS51P4L183B	M83513/03-H16C	MDA1100PEW183B
M83513/03-F11P	MDAS37PEW046B	M83513/03-G14C	MDA151P4W183B	M83513/03-H16N	MDA2100PEW183B
M83513/03-F12C	MDA137PEW092B	M83513/03-G14N	MDA251P4W183B	M83513/03-H16P	MDAS100PEW183B
M83513/03-F12N	MDA237PEW092B	M83513/03-G14P	MDAS51P4W183B		
M83513/03-F12P	MDAS37PEW092B	M83513/03-G15C	MDA151PEL183B		
M83513/03-F13C	MDA137P4L183B	M83513/03-G15N	MDA251PEL183B		
M83513/03-F13N	MDA237P4L183B	M83513/03-G15P	MDAS51PEL183B		
M83513/03-F13P	MDAS37P4L183B	M83513/03-G16C	MDA151PEW183B		
M83513/03-F14C	MDA137P4W183B	M83513/03-G16N	MDA251PEW183B		
M83513/03-F14N	MDA237P4W183B	M83513/03-G16P	MDAS51PEW183B		
M83513/03-F14P	MDAS37P4W183B				
M83513/03-F15C	MDA137PEL183B	M83513/03-H01C	MDA1100P4L046B		
M83513/03-F15N	MDA237PEL183B	M83513/03-H01N	MDA2100P4L046B		
M83513/03-F15P	MDAS37PEL183B	M83513/03-H01P	MDAS100P4L046B		
M83513/03-F16C	MDA137PEW183B	M83513/03-H02C	MDA1100P4L092B		
M83513/03-F16N	MDA237PEW183B	M83513/03-H02N	MDA2100P4L092B		
M83513/03-F16P	MDAS37PEW183B	M83513/03-H02P	MDAS100P4L092B		
M83513/03-G01C	MDA151P4L046B	M83513/03-H03C	MDA1100P4W046B		
M83513/03-G01N	MDA251P4L046B	M83513/03-H03N	MDA2100P4W046B		
M83513/03-G01P	MDAS51P4L046B	M83513/03-H03P	MDAS100P4W046B		
M83513/03-G02C	MDA151P4L092B	M83513/03-H04C	MDA1100P4W092B		
M83513/03-G02N	MDA251P4L092B	M83513/03-H04N	MDA2100P4W092B		
M83513/03-G02P	MDAS51P4L092B	M83513/03-H04P	MDAS100P4W092B		
M83513/03-G03C	MDA151P4W046B	M83513/03-H05C	MDA1100PG002B		
M83513/03-G03N	MDA251P4W046B	M83513/03-H05N	MDA2100PG002B		
M83513/03-G03P	MDAS51P4W046B	M83513/03-H05P	MDAS100PG002B		
M83513/03-G04C	MDA151P4W092B	M83513/03-H06C	MDA1100PG003B		
M83513/03-G04N	MDA251P4W092B	M83513/03-H06N	MDA2100PG003B		
		M83513/03-H06P	MDAS100PG003B		

MIL-DTL-83513
CONNECTORS

Rectangular
Micro-D connectors

M83513/04

MIL STANDARD	AXON' EQUIVALENT	MIL STANDARD	AXON' EQUIVALENT	MIL STANDARD	AXON' EQUIVALENT
M83513/04-A01C	MDA109S4L046B	M83513/04-B04C	MDA115S4W092B	M83513/04-C07C	MDA121ST002B
M83513/04-A01N	MDA209S4L046B	M83513/04-B04N	MDA215S4W092B	M83513/04-C07N	MDA221ST002B
M83513/04-A01P	MDAS09S4L046B	M83513/04-B04P	MDAS15S4W092B	M83513/04-C07P	MDAS21ST002B
M83513/04-A02C	MDA109S4L092B	M83513/04-B05C	MDA115SG002B	M83513/04-C08C	MDA121ST003B
M83513/04-A02N	MDA209S4L092B	M83513/04-B05N	MDA215SG002B	M83513/04-C08N	MDA221ST003B
M83513/04-A02P	MDAS09S4L092B	M83513/04-B05P	MDAS15SG002B	M83513/04-C08P	MDAS21ST003B
M83513/04-A03C	MDA109S4W046B	M83513/04-B06C	MDA115SG003B	M83513/04-C09C	MDA121SEL046B
M83513/04-A03N	MDA209S4W046B	M83513/04-B06N	MDA215SG003B	M83513/04-C09N	MDA221SEL046B
M83513/04-A03P	MDAS09S4W046B	M83513/04-B06P	MDAS15SG003B	M83513/04-C09P	MDAS21SEL046B
M83513/04-A04C	MDA109S4W092B	M83513/04-B07C	MDA115ST002B	M83513/04-C10C	MDA121SEL092B
M83513/04-A04N	MDA209S4W092B	M83513/04-B07N	MDA215ST002B	M83513/04-C10N	MDA221SEL092B
M83513/04-A04P	MDAS09S4W092B	M83513/04-B07P	MDAS15ST002B	M83513/04-C10P	MDAS21SEL092B
M83513/04-A05C	MDA109SG002B	M83513/04-B08C	MDA115ST003B	M83513/04-C11C	MDA121SEW046B
M83513/04-A05N	MDA209SG002B	M83513/04-B08N	MDA215ST003B	M83513/04-C11N	MDA221SEW046B
M83513/04-A05P	MDAS09SG002B	M83513/04-B08P	MDAS15ST003B	M83513/04-C11P	MDAS21SEW046B
M83513/04-A06C	MDA109SG003B	M83513/04-B09C	MDA115SEL046B	M83513/04-C12C	MDA121SEW092B
M83513/04-A06N	MDA209SG003B	M83513/04-B09N	MDA215SEL046B	M83513/04-C12N	MDA221SEW092B
M83513/04-A06P	MDAS09SG003B	M83513/04-B09P	MDAS15SEL046B	M83513/04-C12P	MDAS21SEW092B
M83513/04-A07C	MDA109ST002B	M83513/04-B10C	MDA115SEL092B	M83513/04-C13C	MDA121S4L183B
M83513/04-A07N	MDA209ST002B	M83513/04-B10N	MDA215SEL092B	M83513/04-C13N	MDA221S4L183B
M83513/04-A07P	MDAS09ST002B	M83513/04-B10P	MDAS15SEL092B	M83513/04-C13P	MDAS21S4L183B
M83513/04-A08C	MDA109ST003B	M83513/04-B11C	MDA115SEW046B	M83513/04-C14C	MDA121S4W183B
M83513/04-A08N	MDA209ST003B	M83513/04-B11N	MDA215SEW046B	M83513/04-C14N	MDA221S4W183B
M83513/04-A08P	MDAS09ST003B	M83513/04-B11P	MDAS15SEW046B	M83513/04-C14P	MDAS21S4W183B
M83513/04-A09C	MDA109SEL046B	M83513/04-B12C	MDA115SEW092B	M83513/04-C15C	MDA121SEL183B
M83513/04-A09N	MDA209SEL046B	M83513/04-B12N	MDA215SEW092B	M83513/04-C15N	MDA221SEL183B
M83513/04-A09P	MDAS09SEL046B	M83513/04-B12P	MDAS15SEW092B	M83513/04-C15P	MDAS21SEL183B
M83513/04-A10C	MDA109SEL092B	M83513/04-B13C	MDA115S4L183B	M83513/04-C16C	MDA121SEW183B
M83513/04-A10N	MDA209SEL092B	M83513/04-B13N	MDA215S4L183B	M83513/04-C16N	MDA221SEW183B
M83513/04-A10P	MDAS09SEL092B	M83513/04-B13P	MDAS15S4L183B	M83513/04-C16P	MDAS21SEW183B
M83513/04-A11C	MDA109SEW046B	M83513/04-B14C	MDA115S4W183B	M83513/04-D01C	MDA125S4L046B
M83513/04-A11N	MDA209SEW046B	M83513/04-B14N	MDA215S4W183B	M83513/04-D01N	MDA225S4L046B
M83513/04-A11P	MDAS09SEW046B	M83513/04-B14P	MDAS15S4W183B	M83513/04-D01P	MDAS25S4L046B
M83513/04-A12C	MDA109SEW092B	M83513/04-B15C	MDA115SEL183B	M83513/04-D02C	MDA125S4L092B
M83513/04-A12N	MDA209SEW092B	M83513/04-B15N	MDA215SEL183B	M83513/04-D02N	MDA225S4L092B
M83513/04-A12P	MDAS09SEW092B	M83513/04-B15P	MDAS15SEL183B	M83513/04-D02P	MDAS25S4L092B
M83513/04-A13C	MDA109S4L183B	M83513/04-B16C	MDA115SEW183B	M83513/04-D03C	MDA125S4W046B
M83513/04-A13N	MDA209S4L183B	M83513/04-B16N	MDA215SEW183B	M83513/04-D03N	MDA225S4W046B
M83513/04-A13P	MDAS09S4L183B	M83513/04-B16P	MDAS15SEW183B	M83513/04-D03P	MDAS25S4W046B
M83513/04-A14C	MDA109S4W183B	M83513/04-C01C	MDA121S4L046B	M83513/04-D04C	MDA125S4W092B
M83513/04-A14N	MDA209S4W183B	M83513/04-C01N	MDA221S4L046B	M83513/04-D04N	MDA225S4W092B
M83513/04-A14P	MDAS09S4W183B	M83513/04-C01P	MDAS21S4L046B	M83513/04-D04P	MDAS25S4W092B
M83513/04-A15C	MDA109SEL183B	M83513/04-C02C	MDA121S4L092B	M83513/04-D05C	MDA125SG002B
M83513/04-A15N	MDA209SEL183B	M83513/04-C02N	MDA221S4L092B	M83513/04-D05N	MDA225SG002B
M83513/04-A15P	MDAS09SEL183B	M83513/04-C02P	MDAS21S4L092B	M83513/04-D05P	MDAS25SG002B
M83513/04-A16C	MDA109SEW183B	M83513/04-C03C	MDA121S4W046B	M83513/04-D06C	MDA125SG003B
M83513/04-A16N	MDA209SEW183B	M83513/04-C03N	MDA221S4W046B	M83513/04-D06N	MDA225SG003B
M83513/04-A16P	MDAS09SEW183B	M83513/04-C03P	MDAS21S4W046B	M83513/04-D06P	MDAS25SG003B
M83513/04-B01C	MDA115S4L046B	M83513/04-C04C	MDA121S4W092B	M83513/04-D07C	MDA125ST002B
M83513/04-B01N	MDA215S4L046B	M83513/04-C04N	MDA221S4W092B	M83513/04-D07N	MDA225ST002B
M83513/04-B01P	MDAS15S4L046B	M83513/04-C04P	MDAS21S4W092B	M83513/04-D07P	MDAS25ST002B
M83513/04-B02C	MDA115S4L092B	M83513/04-C05C	MDA121SG002B	M83513/04-D08C	MDA125ST003B
M83513/04-B02N	MDA215S4L092B	M83513/04-C05N	MDA221SG002B	M83513/04-D08N	MDA225ST003B
M83513/04-B02P	MDAS15S4L092B	M83513/04-C05P	MDAS21SG002B	M83513/04-D08P	MDAS25ST003B
M83513/04-B03C	MDA115S4W046B	M83513/04-C06C	MDA121SG003B	M83513/04-D09C	MDA125SEL046B
M83513/04-B03N	MDA215S4W046B	M83513/04-C06N	MDA221SG003B	M83513/04-D09N	MDA225SEL046B
M83513/04-B03P	MDAS15S4W046B	M83513/04-C06P	MDAS21SG003B	M83513/04-D09P	MDAS25SEL046B

MIL-DTL-83513
CONNECTORS

Rectangular
Micro-D connectors

M83513/04 (continued)

MIL STANDARD	AXON' EQUIVALENT	MIL STANDARD	AXON' EQUIVALENT	MIL STANDARD	AXON' EQUIVALENT
M83513/04-D10C	MDA125SEL092B	M83513/04-E13C	MDA131S4L183B	M83513/04-F16C	MDA137SEW183B
M83513/04-D10N	MDA225SEL092B	M83513/04-E13N	MDA231S4L183B	M83513/04-F16N	MDA237SEW183B
M83513/04-D10P	MDAS25SEL092B	M83513/04-E13P	MDAS31S4L183B	M83513/04-F16P	MDAS37SEW183B
M83513/04-D11C	MDA125SEW046B	M83513/04-E14C	MDA131S4W183B	M83513/04-G01C	MDA151S4L046B
M83513/04-D11N	MDA225SEW046B	M83513/04-E14N	MDA231S4W183B	M83513/04-G01N	MDA251S4L046B
M83513/04-D11P	MDAS25SEW046B	M83513/04-E14P	MDAS31S4W183B	M83513/04-G01P	MDAS51S4L046B
M83513/04-D12C	MDA125SEW092B	M83513/04-E15C	MDA131SEL183B	M83513/04-G02C	MDA151S4L092B
M83513/04-D12N	MDA225SEW092B	M83513/04-E15N	MDA231SEL183B	M83513/04-G02N	MDA251S4L092B
M83513/04-D12P	MDAS25SEW092B	M83513/04-E15P	MDAS31SEL183B	M83513/04-G02P	MDAS51S4L092B
M83513/04-D13C	MDA125S4L183B	M83513/04-E16C	MDA131SEW183B	M83513/04-G03C	MDA151S4W046B
M83513/04-D13N	MDA225S4L183B	M83513/04-E16N	MDA231SEW183B	M83513/04-G03N	MDA251S4W046B
M83513/04-D13P	MDAS25S4L183B	M83513/04-E16P	MDAS31SEW183B	M83513/04-G03P	MDAS51S4W046B
M83513/04-D14C	MDA125S4W183B	M83513/04-F01C	MDA137S4L046B	M83513/04-G04C	MDA151S4W092B
M83513/04-D14N	MDA225S4W183B	M83513/04-F01N	MDA237S4L046B	M83513/04-G04N	MDA251S4W092B
M83513/04-D14P	MDAS25S4W183B	M83513/04-F01P	MDAS37S4L046B	M83513/04-G04P	MDAS51S4W092B
M83513/04-D15C	MDA125SEL183B	M83513/04-F02C	MDA137S4L092B	M83513/04-G05C	MDA151SG002B
M83513/04-D15N	MDA225SEL183B	M83513/04-F02N	MDA237S4L092B	M83513/04-G05N	MDA251SG002B
M83513/04-D15P	MDAS25SEL183B	M83513/04-F02P	MDAS37S4L092B	M83513/04-G05P	MDAS51SG002B
M83513/04-D16C	MDA125SEW183B	M83513/04-F03C	MDA137S4W046B	M83513/04-G06C	MDA151SG003B
M83513/04-D16N	MDA225SEW183B	M83513/04-F03N	MDA237S4W046B	M83513/04-G06N	MDA251SG003B
M83513/04-D16P	MDAS25SEW183B	M83513/04-F03P	MDAS37S4W046B	M83513/04-G06P	MDAS51SG003B
M83513/04-E01C	MDA131S4L046B	M83513/04-F04C	MDA137S4W092B	M83513/04-G07C	MDA151ST002B
M83513/04-E01N	MDA231S4L046B	M83513/04-F04N	MDA237S4W092B	M83513/04-G07N	MDA251ST002B
M83513/04-E01P	MDAS31S4L046B	M83513/04-F04P	MDAS37S4W092B	M83513/04-G07P	MDAS51ST002B
M83513/04-E02C	MDA131S4L092B	M83513/04-F05C	MDA137SG002B	M83513/04-G08C	MDA151ST003B
M83513/04-E02N	MDA231S4L092B	M83513/04-F05N	MDA237SG002B	M83513/04-G08N	MDA251ST003B
M83513/04-E02P	MDAS31S4L092B	M83513/04-F05P	MDAS37SG002B	M83513/04-G08P	MDAS51ST003B
M83513/04-E03C	MDA131S4W046B	M83513/04-F06C	MDA137SG003B	M83513/04-G09C	MDA151SEL046B
M83513/04-E03N	MDA231S4W046B	M83513/04-F06N	MDA237SG003B	M83513/04-G09N	MDA251SEL046B
M83513/04-E03P	MDAS31S4W046B	M83513/04-F06P	MDAS37SG003B	M83513/04-G09P	MDAS51SEL046B
M83513/04-E04C	MDA131S4W092B	M83513/04-F07C	MDA137ST002B	M83513/04-G10C	MDA151SEL092B
M83513/04-E04N	MDA231S4W092B	M83513/04-F07N	MDA237ST002B	M83513/04-G10N	MDA251SEL092B
M83513/04-E04P	MDAS31S4W092B	M83513/04-F07P	MDAS37ST002B	M83513/04-G10P	MDAS51SEL092B
M83513/04-E05C	MDA131SG002B	M83513/04-F08C	MDA137ST003B	M83513/04-G11C	MDA151SEW046B
M83513/04-E05N	MDA231SG002B	M83513/04-F08N	MDA237ST003B	M83513/04-G11N	MDA251SEW046B
M83513/04-E05P	MDAS31SG002B	M83513/04-F08P	MDAS37ST003B	M83513/04-G11P	MDAS51SEW046B
M83513/04-E06C	MDA131SG003B	M83513/04-F09C	MDA137SEL046B	M83513/04-G12C	MDA151SEW092B
M83513/04-E06N	MDA231SG003B	M83513/04-F09N	MDA237SEL046B	M83513/04-G12N	MDA251SEW092B
M83513/04-E06P	MDAS31SG003B	M83513/04-F09P	MDAS37SEL046B	M83513/04-G12P	MDAS51SEW092B
M83513/04-E07C	MDA131ST002B	M83513/04-F10C	MDA137SEL092B	M83513/04-G13C	MDA151S4L183B
M83513/04-E07N	MDA231ST002B	M83513/04-F10N	MDA237SEL092B	M83513/04-G13N	MDA251S4L183B
M83513/04-E07P	MDAS31ST002B	M83513/04-F10P	MDAS37SEL092B	M83513/04-G13P	MDAS51S4L183B
M83513/04-E08C	MDA131ST003B	M83513/04-F11C	MDA137SEW046B	M83513/04-G14C	MDA151S4W183B
M83513/04-E08N	MDA231ST003B	M83513/04-F11N	MDA237SEW046B	M83513/04-G14N	MDA251S4W183B
M83513/04-E08P	MDAS31ST003B	M83513/04-F11P	MDAS37SEW046B	M83513/04-G14P	MDAS51S4W183B
M83513/04-E09C	MDA131SEL046B	M83513/04-F12C	MDA137SEW092B	M83513/04-G15C	MDA151SEL183B
M83513/04-E09N	MDA231SEL046B	M83513/04-F12N	MDA237SEW092B	M83513/04-G15N	MDA251SEL183B
M83513/04-E09P	MDAS31SEL046B	M83513/04-F12P	MDAS37SEW092B	M83513/04-G15P	MDAS51SEL183B
M83513/04-E10C	MDA131SEL092B	M83513/04-F13C	MDA137S4L183B	M83513/04-G16C	MDA151SEW183B
M83513/04-E10N	MDA231SEL092B	M83513/04-F13N	MDA237S4L183B	M83513/04-G16N	MDA251SEW183B
M83513/04-E10P	MDAS31SEL092B	M83513/04-F13P	MDAS37S4L183B	M83513/04-G16P	MDAS51SEW183B
M83513/04-E11C	MDA131SEW046B	M83513/04-F14C	MDA137S4W183B	M83513/04-H01C	MDA1100S4L046B
M83513/04-E11N	MDA231SEW046B	M83513/04-F14N	MDA237S4W183B	M83513/04-H01N	MDA2100S4L046B
M83513/04-E11P	MDAS31SEW046B	M83513/04-F14P	MDAS37S4W183B	M83513/04-H01P	MDAS100S4L046B
M83513/04-E12C	MDA131SEW092B	M83513/04-F15C	MDA137SEL183B	M83513/04-H02C	MDA1100S4L092B
M83513/04-E12N	MDA231SEW092B	M83513/04-F15N	MDA237SEL183B	M83513/04-H02N	MDA2100S4L092B
M83513/04-E12P	MDAS31SEW092B	M83513/04-F15P	MDAS37SEL183B	M83513/04-H02P	MDAS100S4L092B

M83513/04 (continued)

MIL STANDARD	AXON' EQUIVALENT	MIL STANDARD	AXON' EQUIVALENT	MIL STANDARD	AXON' EQUIVALENT
M83513/04-H03C	MDA1100S4W046B	M83513/04-H08C	MDA1100ST003B	M83513/04-H13C	MDA1100S4L183B
M83513/04-H03N	MDA2100S4W046B	M83513/04-H08N	MDA2100ST003B	M83513/04-H13N	MDA2100S4L183B
M83513/04-H03P	MDAS100S4W046B	M83513/04-H08P	MDAS100ST003B	M83513/04-H13P	MDAS100S4L183B
M83513/04-H04C	MDA1100S4W092B	M83513/04-H09C	MDA1100SELO46B	M83513/04-H14C	MDA1100S4W183B
M83513/04-H04N	MDA2100S4W092B	M83513/04-H09N	MDA2100SELO46B	M83513/04-H14N	MDA2100S4W183B
M83513/04-H04P	MDAS100S4W092B	M83513/04-H09P	MDAS100SELO46B	M83513/04-H14P	MDAS100S4W183B
M83513/04-H05C	MDA1100SG002B	M83513/04-H10C	MDA1100SELO92B	M83513/04-H15C	MDA1100SEL183B
M83513/04-H05N	MDA2100SG002B	M83513/04-H10N	MDA2100SELO92B	M83513/04-H15N	MDA2100SEL183B
M83513/04-H05P	MDAS100SG002B	M83513/04-H10P	MDAS100SELO92B	M83513/04-H15P	MDAS100SEL183B
M83513/04-H06C	MDA1100SG003B	M83513/04-H11C	MDA1100SEW046B	M83513/04-H16C	MDA1100SEW183B
M83513/04-H06N	MDA2100SG003B	M83513/04-H11N	MDA2100SEW046B	M83513/04-H16N	MDA2100SEW183B
M83513/04-H06P	MDAS100SG003B	M83513/04-H11P	MDAS100SEW046B	M83513/04-H16P	MDA2100SEW183B
M83513/04-H07C	MDA1100ST002B	M83513/04-H12C	MDA1100SEW092B		
M83513/04-H07N	MDA2100ST002B	M83513/04-H12N	MDA2100SEW092B		
M83513/04-H07P	MDAS100ST002B	M83513/04-H12P	MDAS100SEW092B		

M83513/06

MIL STANDARD	AXON' EQUIVALENT	MIL STANDARD	AXON' EQUIVALENT	MIL STANDARD	AXON' EQUIVALENT
M83513/06-A	MDAP09PFBSB	M83513/06-D	MDAP25PFBSB	M83513/06-G	MDAP51PFBSB
M83513/06-B	MDAP15PFBSB	M83513/06-E	MDAP31PFBSB		
M83513/06-C	MDAP21PFBSB	M83513/06-F	MDAP37PFBSB		

M83513/07

MIL STANDARD	AXON' EQUIVALENT	MIL STANDARD	AXON' EQUIVALENT	MIL STANDARD	AXON' EQUIVALENT
M83513/07-A	MDAP09SFBSB	M83513/07-D	MDAP25SFBSB	M83513/07-G	MDAP51SFBSB
M83513/07-B	MDAP15SFBSB	M83513/07-E	MDAP31SFBSB		
M83513/07-C	MDAP21SFBSB	M83513/07-F	MDAP37SFBSB		

M83513/08

MIL STANDARD	AXON' EQUIVALENT	MIL STANDARD	AXON' EQUIVALENT	MIL STANDARD	AXON' EQUIVALENT
M83513/08-A01	MDAP09P4L046B	M83513/08-B08	MDAP15PT003B	M83513/08-C15	MDAP21PEL183B
M83513/08-A02	MDAP09P4L092B	M83513/08-B09	MDAP15PELO46B	M83513/08-C16	MDAP21PEW183B
M83513/08-A03	MDAP09P4W046B	M83513/08-B10	MDAP15PELO92B	M83513/08-D01	MDAP25P4L046B
M83513/08-A04	MDAP09P4W092B	M83513/08-B11	MDAP15PEW046B	M83513/08-D02	MDAP25P4L092B
M83513/08-A05	MDAP09PG002B	M83513/08-B12	MDAP15PEW092B	M83513/08-D03	MDAP25P4W046B
M83513/08-A06	MDAP09PG003B	M83513/08-B13	MDAP15P4L183B	M83513/08-D04	MDAP25P4W092B
M83513/08-A07	MDAP09PT002B	M83513/08-B14	MDAP15P4W183B	M83513/08-D05	MDAP25PG002B
M83513/08-A08	MDAP09PT003B	M83513/08-B15	MDAP15PEL183B	M83513/08-D06	MDAP25PG003B
M83513/08-A09	MDAP09PELO46B	M83513/08-B16	MDAP15PEW183B	M83513/08-D07	MDAP25PT002B
M83513/08-A10	MDAP09PELO92B	M83513/08-C01	MDAP21P4L046B	M83513/08-D08	MDAP25PT003B
M83513/08-A11	MDAP09PEW046B	M83513/08-C02	MDAP21P4L092B	M83513/08-D09	MDAP25PELO46B
M83513/08-A12	MDAP09PEW092B	M83513/08-C03	MDAP21P4W046B	M83513/08-D10	MDAP25PELO92B
M83513/08-A13	MDAP09P4L183B	M83513/08-C04	MDAP21P4W092B	M83513/08-D11	MDAP25PEW046B
M83513/08-A14	MDAP09P4W183B	M83513/08-C05	MDAP21PG002B	M83513/08-D12	MDAP25PEW092B
M83513/08-A15	MDAP09PEL183B	M83513/08-C06	MDAP21PG003B	M83513/08-D13	MDAP25P4L183B
M83513/08-A16	MDAP09PEW183B	M83513/08-C07	MDAP21PT002B	M83513/08-D14	MDAP25P4W183B
M83513/08-B01	MDAP15P4L046B	M83513/08-C08	MDAP21PT003B	M83513/08-D15	MDAP25PEL183B
M83513/08-B02	MDAP15P4L092B	M83513/08-C09	MDAP21PELO46B	M83513/08-D16	MDAP25PEW183B
M83513/08-B03	MDAP15P4W046B	M83513/08-C10	MDAP21PELO92B	M83513/08-E01	MDAP31P4L046B
M83513/08-B04	MDAP15P4W092B	M83513/08-C11	MDAP21PEW046B	M83513/08-E02	MDAP31P4L092B
M83513/08-B05	MDAP15PG002B	M83513/08-C12	MDAP21PEW092B	M83513/08-E03	MDAP31P4W046B
M83513/08-B06	MDAP15PG003B	M83513/08-C13	MDAP21P4L183B	M83513/08-E04	MDAP31P4W092B
M83513/08-B07	MDAP15PT002B	M83513/08-C14	MDAP21P4W183B		

M83513/08 (continued)

MIL STANDARD	AXON' EQUIVALENT	MIL STANDARD	AXON' EQUIVALENT	MIL STANDARD	AXON' EQUIVALENT
M83513/08-E05	MDAP31PG002B	M83513/08-F04	MDAP37P4W092B	M83513/08-G03	MDAP51P4W046B
M83513/08-E06	MDAP31PG003B	M83513/08-F05	MDAP37PG002B	M83513/08-G04	MDAP51P4W092B
M83513/08-E07	MDAP31PT002B	M83513/08-F06	MDAP37PG003B	M83513/08-G05	MDAP51PG002B
M83513/08-E08	MDAP31PT003B	M83513/08-F07	MDAP37PT002B	M83513/08-G06	MDAP51PG003B
M83513/08-E09	MDAP31PEL046B	M83513/08-F08	MDAP37PT003B	M83513/08-G07	MDAP51PT002B
M83513/08-E10	MDAP31PEL092B	M83513/08-F09	MDAP37PEL046B	M83513/08-G08	MDAP51PT003B
M83513/08-E11	MDAP31PEW046B	M83513/08-F10	MDAP37PEL092B	M83513/08-G09	MDAP51PEL046B
M83513/08-E12	MDAP31PEW092B	M83513/08-F11	MDAP37PEW046B	M83513/08-G10	MDAP51PEL092B
M83513/08-E13	MDAP31P4L183B	M83513/08-F12	MDAP37PEW092B	M83513/08-G11	MDAP51PEW046B
M83513/08-E14	MDAP31P4W183B	M83513/08-F13	MDAP37P4L183B	M83513/08-G12	MDAP51PEW092B
M83513/08-E15	MDAP31PEL183B	M83513/08-F14	MDAP37P4W183B	M83513/08-G13	MDAP51P4L183B
M83513/08-E16	MDAP31PEW183B	M83513/08-F15	MDAP37PEL183B	M83513/08-G14	MDAP51P4W183B
M83513/08-F01	MDAP37P4L046B	M83513/08-F16	MDAP37PEW183B	M83513/08-G15	MDAP51PEL183B
M83513/08-F02	MDAP37P4L092B	M83513/08-G01	MDAP51P4L046B	M83513/08-G16	MDAP51PEW183B
M83513/08-F03	MDAP37P4W046B	M83513/08-G02	MDAP51P4L092B		

M83513/09

MIL STANDARD	AXON' EQUIVALENT	MIL STANDARD	AXON' EQUIVALENT	MIL STANDARD	AXON' EQUIVALENT
M83513/09-A01	MDAP09S4L046B	M83513/09-C07	MDAP21ST002B	M83513/09-E13	MDAP31S4L183B
M83513/09-A02	MDAP09S4L092B	M83513/09-C08	MDAP21ST003B	M83513/09-E14	MDAP31S4W183B
M83513/09-A03	MDAP09S4W046B	M83513/09-C09	MDAP21SEL046B	M83513/09-E15	MDAP31SEL183B
M83513/09-A04	MDAP09S4W092B	M83513/09-C10	MDAP21SEL092B	M83513/09-E16	MDAP31SEW183B
M83513/09-A05	MDAP09SG002B	M83513/09-C11	MDAP21SEW046B	M83513/09-F01	MDAP37S4L046B
M83513/09-A06	MDAP09SG003B	M83513/09-C12	MDAP21SEW092B	M83513/09-F02	MDAP37S4L092B
M83513/09-A07	MDAP09ST002B	M83513/09-C13	MDAP21S4L183B	M83513/09-F03	MDAP37S4W046B
M83513/09-A08	MDAP09ST003B	M83513/09-C14	MDAP21S4W183B	M83513/09-F04	MDAP37S4W092B
M83513/09-A09	MDAP09SEL046B	M83513/09-C15	MDAP21SEL183B	M83513/09-F05	MDAP37SG002B
M83513/09-A10	MDAP09SEL092B	M83513/09-C16	MDAP21SEW183B	M83513/09-F06	MDAP37SG003B
M83513/09-A11	MDAP09SEW046B	M83513/09-D01	MDAP25S4L046B	M83513/09-F07	MDAP37ST002B
M83513/09-A12	MDAP09SEW092B	M83513/09-D02	MDAP25S4L092B	M83513/09-F08	MDAP37ST003B
M83513/09-A13	MDAP09S4L183B	M83513/09-D03	MDAP25S4W046B	M83513/09-F09	MDAP37SELO46B
M83513/09-A14	MDAP09S4W183B	M83513/09-D04	MDAP25S4W092B	M83513/09-F10	MDAP37SELO92B
M83513/09-A15	MDAP09SEL183B	M83513/09-D05	MDAP25SG002B	M83513/09-F11	MDAP37SEW046B
M83513/09-A16	MDAP09SEW183B	M83513/09-D06	MDAP25SG003B	M83513/09-F12	MDAP37SEW092B
M83513/09-B01	MDAP15P4L046B	M83513/09-D07	MDAP25ST002B	M83513/09-F13	MDAP37S4L183B
M83513/09-B02	MDAP15P4L092B	M83513/09-D08	MDAP25ST003B	M83513/09-F14	MDAP37S4W183B
M83513/09-B03	MDAP15P4W046B	M83513/09-D09	MDAP25SELO46B	M83513/09-F15	MDAP37SEL183B
M83513/09-B04	MDAP15P4W092B	M83513/09-D10	MDAP25SELO92B	M83513/09-F16	MDAP37SEW183B
M83513/09-B05	MDAP15PG002B	M83513/09-D11	MDAP25SEW046B	M83513/09-G01	MDAP51S4L046B
M83513/09-B06	MDAP15PG003B	M83513/09-D12	MDAP25SEW092B	M83513/09-G02	MDAP51S4L092B
M83513/09-B07	MDAP15PT002B	M83513/09-D13	MDAP25S4L183B	M83513/09-G03	MDAP51S4W046B
M83513/09-B08	MDAP15PT003B	M83513/09-D14	MDAP25S4W183B	M83513/09-G04	MDAP51S4W092B
M83513/09-B09	MDAP15PEL046B	M83513/09-D15	MDAP25SEL183B	M83513/09-G05	MDAP51SG002B
M83513/09-B10	MDAP15PEL092B	M83513/09-D16	MDAP25SEW183B	M83513/09-G06	MDAP51SG003B
M83513/09-B11	MDAP15PEW046B	M83513/09-E01	MDAP31S4L046B	M83513/09-G07	MDAP51ST002B
M83513/09-B12	MDAP15PEW092B	M83513/09-E02	MDAP31S4L092B	M83513/09-G08	MDAP51ST003B
M83513/09-B13	MDAP15P4L183B	M83513/09-E03	MDAP31S4W046B	M83513/09-G09	MDAP51SELO46B
M83513/09-B14	MDAP15P4W183B	M83513/09-E04	MDAP31S4W092B	M83513/09-G10	MDAP51SELO92B
M83513/09-B15	MDAP15PEL183B	M83513/09-E05	MDAP31SG002B	M83513/09-G11	MDAP51SEW046B
M83513/09-B16	MDAP15PEW183B	M83513/09-E06	MDAP31SG003B	M83513/09-G12	MDAP51SEW092B
M83513/09-C01	MDAP21S4L046B	M83513/09-E07	MDAP31ST002B	M83513/09-G13	MDAP51S4L183B
M83513/09-C02	MDAP21S4L092B	M83513/09-E08	MDAP31ST003B	M83513/09-G14	MDAP51S4W183B
M83513/09-C03	MDAP21S4W046B	M83513/09-E09	MDAP31SELO46B	M83513/09-G15	MDAP51SEL183B
M83513/09-C04	MDAP21S4W092B	M83513/09-E10	MDAP31SELO92B	M83513/09-G16	MDAP51SEW183B
M83513/09-C05	MDAP21SG002B	M83513/09-E11	MDAP31SEW046B		
M83513/09-C06	MDAP21SG003B	M83513/09-E12	MDAP31SEW092B		

MIL-DTL-83513
CONNECTORS

Rectangular
Micro-D connectors

M83513/10

MIL STANDARD	AXON' EQUIVALENT	MIL STANDARD	AXON' EQUIVALENT	MIL STANDARD	AXON' EQUIVALENT
M83513/10-A01CN	MDA109PCBRBG1	M83513/10-B02PP	MDAS15PCBRPG2	M83513/10-D01NT	MDA225PCBRTG1
M83513/10-A01CP	MDA109PCBRPG1	M83513/10-B02PT	MDAS15PCBRTG2	M83513/10-D01NW	MDA225PCBRWG1
M83513/10-A01CT	MDA109PCBRTG1	M83513/10-B02PW	MDAS15PCBRWG2	M83513/10-D01PN	MDAS25PCBRBG1
M83513/10-A01CW	MDA109PCBRWG1	M83513/10-B03CN	MDA115PCBRBG3	M83513/10-D01PP	MDAS25PCBRPG1
M83513/10-A01NN	MDA209PCBRBG1	M83513/10-B03CP	MDA115PCBRPG3	M83513/10-D01PT	MDAS25PCBRTG1
M83513/10-A01NP	MDA209PCBRPG1	M83513/10-B03CT	MDA115PCBRTG3	M83513/10-D01PW	MDAS25PCBRWG1
M83513/10-A01NT	MDA209PCBRTG1	M83513/10-B03CW	MDA115PCBRWG3	M83513/10-D02CN	MDA125PCBRBG2
M83513/10-A01NW	MDA209PCBRWG1	M83513/10-B03NN	MDA215PCBRBG3	M83513/10-D02CP	MDA125PCBRPG2
M83513/10-A01PN	MDAS09PCBRBG1	M83513/10-B03NP	MDA215PCBRPG3	M83513/10-D02CT	MDA125PCBRTG2
M83513/10-A01PP	MDAS09PCBRPG1	M83513/10-B03NT	MDA215PCBRTG3	M83513/10-D02CW	MDA125PCBRWG2
M83513/10-A01PT	MDAS09PCBRTG1	M83513/10-B03NW	MDA215PCBRWG3	M83513/10-D02NN	MDA225PCBRBG2
M83513/10-A01PW	MDAS09PCBRWG1	M83513/10-B03PN	MDAS15PCBRBG3	M83513/10-D02NP	MDA225PCBRPG2
M83513/10-A02CN	MDA109PCBRBG2	M83513/10-B03PP	MDAS15PCBRPG3	M83513/10-D02NT	MDA225PCBRTG2
M83513/10-A02CP	MDA109PCBRPG2	M83513/10-B03PT	MDAS15PCBRTG3	M83513/10-D02NW	MDA225PCBRWG2
M83513/10-A02CT	MDA109PCBRTG2	M83513/10-B03PW	MDAS15PCBRWG3	M83513/10-D02PN	MDAS25PCBRBG2
M83513/10-A02CW	MDA109PCBRWG2	M83513/10-C01CN	MDA121PCBRBG1	M83513/10-D02PP	MDAS25PCBRPG2
M83513/10-A02NN	MDA209PCBRBG2	M83513/10-C01CP	MDA121PCBRPG1	M83513/10-D02PT	MDAS25PCBRTG2
M83513/10-A02NP	MDA209PCBRPG2	M83513/10-C01CT	MDA121PCBRTG1	M83513/10-D02PW	MDAS25PCBRWG2
M83513/10-A02NT	MDA209PCBRTG2	M83513/10-C01CW	MDA121PCBRWG1	M83513/10-D03CN	MDA125PCBRBG3
M83513/10-A02NW	MDA209PCBRWG2	M83513/10-C01NN	MDA221PCBRBG1	M83513/10-D03CP	MDA125PCBRPG3
M83513/10-A02PN	MDAS09PCBRBG2	M83513/10-C01NP	MDA221PCBRPG1	M83513/10-D03CT	MDA125PCBRTG3
M83513/10-A02PP	MDAS09PCBRPG2	M83513/10-C01NT	MDA221PCBRTG1	M83513/10-D03CW	MDA125PCBRWG3
M83513/10-A02PT	MDAS09PCBRTG2	M83513/10-C01NW	MDA221PCBRWG1	M83513/10-D03NN	MDA225PCBRBG3
M83513/10-A02PW	MDAS09PCBRWG2	M83513/10-C01PN	MDAS21PCBRBG1	M83513/10-D03NP	MDA225PCBRPG3
M83513/10-A03CN	MDA109PCBRBG3	M83513/10-C01PP	MDAS21PCBRPG1	M83513/10-D03NT	MDA225PCBRTG3
M83513/10-A03CP	MDA109PCBRPG3	M83513/10-C01PT	MDAS21PCBRTG1	M83513/10-D03NW	MDA225PCBRWG3
M83513/10-A03CT	MDA109PCBRTG3	M83513/10-C01PW	MDAS21PCBRWG1	M83513/10-D03PN	MDAS25PCBRBG3
M83513/10-A03CW	MDA109PCBRWG3	M83513/10-C02CN	MDA121PCBRBG2	M83513/10-D03PP	MDAS25PCBRPG3
M83513/10-A03NN	MDA209PCBRBG3	M83513/10-C02CP	MDA121PCBRPG2	M83513/10-D03PT	MDAS25PCBRTG3
M83513/10-A03NP	MDA209PCBRPG3	M83513/10-C02CT	MDA121PCBRTG2	M83513/10-D03PW	MDAS25PCBRWG3
M83513/10-A03NT	MDA209PCBRTG3	M83513/10-C02CW	MDA121PCBRWG2	M83513/10-E01CN	MDA131PCBRBG1
M83513/10-A03NW	MDA209PCBRWG3	M83513/10-C02NN	MDA221PCBRBG2	M83513/10-E01CP	MDA131PCBRPG1
M83513/10-A03PN	MDAS09PCBRBG3	M83513/10-C02NP	MDA221PCBRPG2	M83513/10-E01CT	MDA131PCBRTG1
M83513/10-A03PP	MDAS09PCBRPG3	M83513/10-C02NT	MDA221PCBRTG2	M83513/10-E01CW	MDA131PCBRWG1
M83513/10-A03PT	MDAS09PCBRTG3	M83513/10-C02NW	MDA221PCBRWG2	M83513/10-E01NN	MDA231PCBRBG1
M83513/10-A03PW	MDAS09PCBRWG3	M83513/10-C02PN	MDAS21PCBRBG2	M83513/10-E01NP	MDA231PCBRPG1
M83513/10-B01CN	MDA115PCBRBG1	M83513/10-C02PP	MDAS21PCBRPG2	M83513/10-E01NT	MDA231PCBRTG1
M83513/10-B01CP	MDA115PCBRPG1	M83513/10-C02PT	MDAS21PCBRTG2	M83513/10-E01NW	MDA231PCBRWG1
M83513/10-B01CT	MDA115PCBRTG1	M83513/10-C02PW	MDAS21PCBRWG2	M83513/10-E01PN	MDAS31PCBRBG1
M83513/10-B01CW	MDA115PCBRWG1	M83513/10-C03CN	MDA121PCBRBG3	M83513/10-E01PP	MDAS31PCBRPG1
M83513/10-B01NN	MDA215PCBRBG1	M83513/10-C03CP	MDA121PCBRPG3	M83513/10-E01PT	MDAS31PCBRTG1
M83513/10-B01NP	MDA215PCBRPG1	M83513/10-C03CT	MDA121PCBRTG3	M83513/10-E01PW	MDAS31PCBRWG1
M83513/10-B01NT	MDA215PCBRTG1	M83513/10-C03CW	MDA121PCBRWG3	M83513/10-E02CN	MDA131PCBRBG2
M83513/10-B01NW	MDA215PCBRWG1	M83513/10-C03NN	MDA221PCBRBG3	M83513/10-E02CP	MDA131PCBRPG2
M83513/10-B01PN	MDAS15PCBRBG1	M83513/10-C03NP	MDA221PCBRPG3	M83513/10-E02CT	MDA131PCBRTG2
M83513/10-B01PP	MDAS15PCBRPG1	M83513/10-C03NT	MDA221PCBRTG3	M83513/10-E02CW	MDA131PCBRWG2
M83513/10-B01PT	MDAS15PCBRTG1	M83513/10-C03NW	MDA221PCBRWG3	M83513/10-E02NN	MDA231PCBRBG2
M83513/10-B01PW	MDAS15PCBRWG1	M83513/10-C03PN	MDAS21PCBRBG3	M83513/10-E02NP	MDA231PCBRPG2
M83513/10-B02CN	MDA115PCBRBG2	M83513/10-C03PP	MDAS21PCBRPG3	M83513/10-E02NT	MDA231PCBRTG2
M83513/10-B02CP	MDA115PCBRPG2	M83513/10-C03PT	MDAS21PCBRTG3	M83513/10-E02NW	MDA231PCBRWG2
M83513/10-B02CT	MDA115PCBRTG2	M83513/10-C03PW	MDAS21PCBRWG3	M83513/10-E02PN	MDAS31PCBRBG2
M83513/10-B02CW	MDA115PCBRWG2	M83513/10-D01CN	MDA125PCBRBG1	M83513/10-E02PP	MDAS31PCBRPG2
M83513/10-B02NN	MDA215PCBRBG2	M83513/10-D01CP	MDA125PCBRPG1	M83513/10-E02PT	MDAS31PCBRTG2
M83513/10-B02NP	MDA215PCBRPG2	M83513/10-D01CT	MDA125PCBRTG1	M83513/10-E02PW	MDAS31PCBRWG2
M83513/10-B02NT	MDA215PCBRTG2	M83513/10-D01CW	MDA125PCBRWG1	M83513/10-E03CN	MDA131PCBRBG3
M83513/10-B02NW	MDA215PCBRWG2	M83513/10-D01NN	MDA225PCBRBG1	M83513/10-E03CP	MDA131PCBRPG3
M83513/10-B02PN	MDAS15PCBRBG2	M83513/10-D01NP	MDA225PCBRPG1	M83513/10-E03CT	MDA131PCBRTG3

MIL-DTL-83513
CONNECTORS

Rectangular
Micro-D connectors

M83513/10 (continued)

MIL STANDARD	AXON' EQUIVALENT	MIL STANDARD	AXON' EQUIVALENT	MIL STANDARD	AXON' EQUIVALENT
M83513/10-E03CW	MDA131PCBRWG3	M83513/10-F01NW	MDA237PCBRWG1	M83513/10-F02PW	MDAS37PCBRWG2
M83513/10-E03NN	MDA231PCBRBG3	M83513/10-F01PN	MDAS37PCBRBG1	M83513/10-F03CN	MDA137PCBRBG3
M83513/10-E03NP	MDA231PCBRPG3	M83513/10-F01PP	MDAS37PCBRPG1	M83513/10-F03CP	MDA137PCBRPG3
M83513/10-E03NT	MDA231PCBRTG3	M83513/10-F01PT	MDAS37PCBRTG1	M83513/10-F03CT	MDA137PCBRTG3
M83513/10-E03NW	MDA231PCBRWG3	M83513/10-F01PW	MDAS37PCBRWG1	M83513/10-F03CW	MDA137PCBRWG3
M83513/10-E03PN	MDAS31PCBRBG3	M83513/10-F02CN	MDA137PCBRBG2	M83513/10-F03NN	MDA237PCBRBG3
M83513/10-E03PP	MDAS31PCBRPG3	M83513/10-F02CP	MDA137PCBRPG2	M83513/10-F03NP	MDA237PCBRPG3
M83513/10-E03PT	MDAS31PCBRTG3	M83513/10-F02CT	MDA137PCBRTG2	M83513/10-F03NT	MDA237PCBRTG3
M83513/10-E03PW	MDAS31PCBRWG3	M83513/10-F02CW	MDA137PCBRWG2	M83513/10-F03NW	MDA237PCBRWG3
M83513/10-F01CN	MDA137PCBRBG1	M83513/10-F02NN	MDA237PCBRBG2	M83513/10-F03PN	MDAS37PCBRBG3
M83513/10-F01CP	MDA137PCBRPG1	M83513/10-F02NP	MDA237PCBRPG2	M83513/10-F03PP	MDAS37PCBRPG3
M83513/10-F01CT	MDA137PCBRTG1	M83513/10-F02NT	MDA237PCBRTG2	M83513/10-F03PT	MDAS37PCBRTG3
M83513/10-F01CW	MDA137PCBRWG1	M83513/10-F02NW	MDA237PCBRWG2	M83513/10-F03PW	MDAS37PCBRWG3
M83513/10-F01NN	MDA237PCBRBG1	M83513/10-F02PN	MDAS37PCBRBG2		
M83513/10-F01NP	MDA237PCBRPG1	M83513/10-F02PP	MDAS37PCBRPG2		
M83513/10-F01NT	MDA237PCBRTG1	M83513/10-F02PT	MDAS37PCBRTG2		

M83513/11

MIL STANDARD	AXON' EQUIVALENT	MIL STANDARD	AXON' EQUIVALENT	MIL STANDARD	AXON' EQUIVALENT
M83513/11-G01CN	MDA151PCBRBG1	M83513/11-G02CN	MDA151PCBRBG2	M83513/11-G03CN	MDA151PCBRBG3
M83513/11-G01CP	MDA151PCBRPG1	M83513/11-G02CP	MDA151PCBRPG2	M83513/11-G03CP	MDA151PCBRPG3
M83513/11-G01CT	MDA151PCBRTG1	M83513/11-G02CT	MDA151PCBRTG2	M83513/11-G03CT	MDA151PCBRTG3
M83513/11-G01CW	MDA151PCBRWG1	M83513/11-G02CW	MDA151PCBRWG2	M83513/11-G03CW	MDA151PCBRWG3
M83513/11-G01NN	MDA251PCBRBG1	M83513/11-G02NN	MDA251PCBRBG2	M83513/11-G03NN	MDA251PCBRBG3
M83513/11-G01NP	MDA251PCBRPG1	M83513/11-G02NP	MDA251PCBRPG2	M83513/11-G03NP	MDA251PCBRPG3
M83513/11-G01NT	MDA251PCBRTG1	M83513/11-G02NT	MDA251PCBRTG2	M83513/11-G03NT	MDA251PCBRTG3
M83513/11-G01NW	MDA251PCBRWG1	M83513/11-G02NW	MDA251PCBRWG2	M83513/11-G03NW	MDA251PCBRWG3
M83513/11-G01PN	MDAS51PCBRBG1	M83513/11-G02PN	MDAS51PCBRBG2	M83513/11-G03PN	MDAS51PCBRBG3
M83513/11-G01PP	MDAS51PCBRPG1	M83513/11-G02PP	MDAS51PCBRPG2	M83513/11-G03PP	MDAS51PCBRPG3
M83513/11-G01PT	MDAS51PCBRTG1	M83513/11-G02PT	MDAS51PCBRTG2	M83513/11-G03PT	MDAS51PCBRTG3
M83513/11-G01PW	MDAS51PCBRWG1	M83513/11-G02PW	MDAS51PCBRWG2	M83513/11-G03PW	MDAS51PCBRWG3

M83513/12

MIL STANDARD	AXON' EQUIVALENT	MIL STANDARD	AXON' EQUIVALENT	MIL STANDARD	AXON' EQUIVALENT
M83513/12-H01CN	MDA1100PCBRBG1	M83513/12-H02CN	MDA1100PCBRBG2	M83513/12-H03CN	MDA1100PCBRBG3
M83513/12-H01CP	MDA1100PCBRPG1	M83513/12-H02CP	MDA1100PCBRPG2	M83513/12-H03CP	MDA1100PCBRPG3
M83513/12-H01CU	MDA1100PCBRTG1	M83513/12-H02CU	MDA1100PCBRTG2	M83513/12-H03CU	MDA1100PCBRTG3
M83513/12-H01CY	MDA1100PCBRWG1	M83513/12-H02CY	MDA1100PCBRWG2	M83513/12-H03CY	MDA1100PCBRWG3
M83513/12-H01NN	MDA2100PCBRBG1	M83513/12-H02NN	MDA2100PCBRBG2	M83513/12-H03NN	MDA2100PCBRBG3
M83513/12-H01NP	MDA2100PCBRPG1	M83513/12-H02NP	MDA2100PCBRPG2	M83513/12-H03NP	MDA2100PCBRPG3
M83513/12-H01NU	MDA2100PCBRTG1	M83513/12-H02NU	MDA2100PCBRTG2	M83513/12-H03NU	MDA2100PCBRTG3
M83513/12-H01NY	MDA2100PCBRWG1	M83513/12-H02NY	MDA2100PCBRWG2	M83513/12-H03NY	MDA2100PCBRWG3
M83513/12-H01PN	MDAS100PCBRBG1	M83513/12-H02PN	MDAS100PCBRBG2	M83513/12-H03PN	MDAS100PCBRBG3
M83513/12-H01PP	MDAS100PCBRPG1	M83513/12-H02PP	MDAS100PCBRPG2	M83513/12-H03PP	MDAS100PCBRPG3
M83513/12-H01PU	MDAS100PCBRTG1	M83513/12-H02PU	MDAS100PCBRTG2	M83513/12-H03PU	MDAS100PCBRTG3
M83513/12-H01PY	MDAS100PCBRWG1	M83513/12-H02PY	MDAS100PCBRWG2	M83513/12-H03PY	MDAS100PCBRWG3

MIL-DTL-83513
CONNECTORS

Rectangular
Micro-D connectors

M83513/13

MIL STANDARD	AXON' EQUIVALENT	MIL STANDARD	AXON' EQUIVALENT	MIL STANDARD	AXON' EQUIVALENT
M83513/13-A01CN	MDA109SCBRBG1	M83513/13-B02PP	MDAS15SCBRPG2	M83513/13-D01NT	MDA225SCBRTG1
M83513/13-A01CP	MDA109SCBRPG1	M83513/13-B02PT	MDAS15SCBRTG2	M83513/13-D01NW	MDA225SCBRWG1
M83513/13-A01CT	MDA109SCBRTG1	M83513/13-B02PW	MDAS15SCBRWG2	M83513/13-D01PN	MDAS25SCBRBG1
M83513/13-A01CW	MDA109SCBRWG1	M83513/13-B03CN	MDA115SCBRBG3	M83513/13-D01PP	MDAS25SCBRPG1
M83513/13-A01NN	MDA209SCBRBG1	M83513/13-B03CP	MDA115SCBRPG3	M83513/13-D01PT	MDAS25SCBRTG1
M83513/13-A01NP	MDA209SCBRPG1	M83513/13-B03CT	MDA115SCBRTG3	M83513/13-D01PW	MDAS25SCBRWG1
M83513/13-A01NT	MDA209SCBRTG1	M83513/13-B03CW	MDA115SCBRWG3	M83513/13-D02CN	MDA125SCBRBG2
M83513/13-A01NW	MDA209SCBRWG1	M83513/13-B03NN	MDA215SCBRBG3	M83513/13-D02CP	MDA125SCBRPG2
M83513/13-A01PN	MDAS09SCBRBG1	M83513/13-B03NP	MDA215SCBRPG3	M83513/13-D02CT	MDA125SCBRTG2
M83513/13-A01PP	MDAS09SCBRPG1	M83513/13-B03NT	MDA215SCBRTG3	M83513/13-D02CW	MDA125SCBRWG2
M83513/13-A01PT	MDAS09SCBRTG1	M83513/13-B03NW	MDA215SCBRWG3	M83513/13-D02NN	MDA225SCBRBG2
M83513/13-A01PW	MDAS09SCBRWG1	M83513/13-B03PN	MDAS15SCBRBG3	M83513/13-D02NP	MDA225SCBRPG2
M83513/13-A02CN	MDA109SCBRBG2	M83513/13-B03PP	MDAS15SCBRPG3	M83513/13-D02NT	MDA225SCBRTG2
M83513/13-A02CP	MDA109SCBRPG2	M83513/13-B03PT	MDAS15SCBRTG3	M83513/13-D02NW	MDA225SCBRWG2
M83513/13-A02CT	MDA109SCBRTG2	M83513/13-B03PW	MDAS15SCBRWG3	M83513/13-D02PN	MDAS25SCBRBG2
M83513/13-A02CW	MDA109SCBRWG2	M83513/13-C01CN	MDA121SCBRBG1	M83513/13-D02PP	MDAS25SCBRPG2
M83513/13-A02NN	MDA209SCBRBG2	M83513/13-C01CP	MDA121SCBRPG1	M83513/13-D02PT	MDAS25SCBRTG2
M83513/13-A02NP	MDA209SCBRPG2	M83513/13-C01CT	MDA121SCBRTG1	M83513/13-D02PW	MDAS25SCBRWG2
M83513/13-A02NT	MDA209SCBRTG2	M83513/13-C01CW	MDA121SCBRWG1	M83513/13-D03CN	MDA125SCBRBG3
M83513/13-A02NW	MDA209SCBRWG2	M83513/13-C01NN	MDA221SCBRBG1	M83513/13-D03CP	MDA125SCBRPG3
M83513/13-A02PN	MDAS09SCBRBG2	M83513/13-C01NP	MDA221SCBRPG1	M83513/13-D03CT	MDA125SCBRTG3
M83513/13-A02PP	MDAS09SCBRPG2	M83513/13-C01NT	MDA221SCBRTG1	M83513/13-D03CW	MDA125SCBRWG3
M83513/13-A02PT	MDAS09SCBRTG2	M83513/13-C01NW	MDA221SCBRWG1	M83513/13-D03NN	MDA225SCBRBG3
M83513/13-A02PW	MDAS09SCBRWG2	M83513/13-C01PN	MDAS21SCBRBG1	M83513/13-D03NP	MDA225SCBRPG3
M83513/13-A03CN	MDA109SCBRBG3	M83513/13-C01PP	MDAS21SCBRPG1	M83513/13-D03NT	MDA225SCBRTG3
M83513/13-A03CP	MDA109SCBRPG3	M83513/13-C01PT	MDAS21SCBRTG1	M83513/13-D03NW	MDA225SCBRWG3
M83513/13-A03CT	MDA109SCBRTG3	M83513/13-C01PW	MDAS21SCBRWG1	M83513/13-D03PN	MDAS25SCBRBG3
M83513/13-A03CW	MDA109SCBRWG3	M83513/13-C02CN	MDA121SCBRBG2	M83513/13-D03PP	MDAS25SCBRPG3
M83513/13-A03NN	MDA209SCBRBG3	M83513/13-C02CP	MDA121SCBRPG2	M83513/13-D03PT	MDAS25SCBRTG3
M83513/13-A03NP	MDA209SCBRPG3	M83513/13-C02CT	MDA121SCBRTG2	M83513/13-D03PW	MDAS25SCBRWG3
M83513/13-A03NT	MDA209SCBRTG3	M83513/13-C02CW	MDA121SCBRWG2	M83513/13-E01CN	MDA131SCBRBG1
M83513/13-A03NW	MDA209SCBRWG3	M83513/13-C02NN	MDA221SCBRBG2	M83513/13-E01CP	MDA131SCBRPG1
M83513/13-A03PN	MDAS09SCBRBG3	M83513/13-C02NP	MDA221SCBRPG2	M83513/13-E01CT	MDA131SCBRTG1
M83513/13-A03PP	MDAS09SCBRPG3	M83513/13-C02NT	MDA221SCBRTG2	M83513/13-E01CW	MDA131SCBRWG1
M83513/13-A03PT	MDAS09SCBRTG3	M83513/13-C02NW	MDA221SCBRWG2	M83513/13-E01NN	MDA231SCBRBG1
M83513/13-A03PW	MDAS09SCBRWG3	M83513/13-C02PN	MDAS21SCBRBG2	M83513/13-E01NP	MDA231SCBRPG1
M83513/13-B01CN	MDA115SCBRBG1	M83513/13-C02PP	MDAS21SCBRPG2	M83513/13-E01NT	MDA231SCBRTG1
M83513/13-B01CP	MDA115SCBRPG1	M83513/13-C02PT	MDAS21SCBRTG2	M83513/13-E01NW	MDA231SCBRWG1
M83513/13-B01CT	MDA115SCBRTG1	M83513/13-C02PW	MDAS21SCBRWG2	M83513/13-E01PN	MDAS31SCBRBG1
M83513/13-B01CW	MDA115SCBRWG1	M83513/13-C03CN	MDA121SCBRBG3	M83513/13-E01PP	MDAS31SCBRPG1
M83513/13-B01NN	MDA215SCBRBG1	M83513/13-C03CP	MDA121SCBRPG3	M83513/13-E01PT	MDAS31SCBRTG1
M83513/13-B01NP	MDA215SCBRPG1	M83513/13-C03CT	MDA121SCBRTG3	M83513/13-E01PW	MDAS31SCBRWG1
M83513/13-B01NT	MDA215SCBRTG1	M83513/13-C03CW	MDA121SCBRWG3	M83513/13-E02CN	MDA131SCBRBG2
M83513/13-B01NW	MDA215SCBRWG1	M83513/13-C03NN	MDA221SCBRBG3	M83513/13-E02CP	MDA131SCBRPG2
M83513/13-B01PN	MDAS15SCBRBG1	M83513/13-C03NP	MDA221SCBRPG3	M83513/13-E02CT	MDA131SCBRTG2
M83513/13-B01PP	MDAS15SCBRPG1	M83513/13-C03NT	MDA221SCBRTG3	M83513/13-E02CW	MDA131SCBRWG2
M83513/13-B01PT	MDAS15SCBRTG1	M83513/13-C03NW	MDA221SCBRWG3	M83513/13-E02NN	MDA231SCBRBG2
M83513/13-B01PW	MDAS15SCBRWG1	M83513/13-C03PN	MDAS21SCBRBG3	M83513/13-E02NP	MDA231SCBRPG2
M83513/13-B02CN	MDA115SCBRBG2	M83513/13-C03PP	MDAS21SCBRPG3	M83513/13-E02NT	MDA231SCBRTG2
M83513/13-B02CP	MDA115SCBRPG2	M83513/13-C03PT	MDAS21SCBRTG3	M83513/13-E02NW	MDA231SCBRWG2
M83513/13-B02CT	MDA115SCBRTG2	M83513/13-C03PW	MDAS21SCBRWG3	M83513/13-E02PN	MDAS31SCBRBG2
M83513/13-B02CW	MDA115SCBRWG2	M83513/13-D01CN	MDA125SCBRBG1	M83513/13-E02PP	MDAS31SCBRPG2
M83513/13-B02NN	MDA215SCBRBG2	M83513/13-D01CP	MDA125SCBRPG1	M83513/13-E02PT	MDAS31SCBRTG2
M83513/13-B02NP	MDA215SCBRPG2	M83513/13-D01CT	MDA125SCBRTG1	M83513/13-E02PW	MDAS31SCBRWG2
M83513/13-B02NT	MDA215SCBRTG2	M83513/13-D01CW	MDA125SCBRWG1	M83513/13-E03CN	MDA131SCBRBG3
M83513/13-B02NW	MDA215SCBRWG2	M83513/13-D01NN	MDA225SCBRBG1	M83513/13-E03CP	MDA131SCBRPG3
M83513/13-B02PN	MDAS15SCBRBG2	M83513/13-D01NP	MDA225SCBRPG1	M83513/13-E03CT	MDA131SCBRTG3

MIL-DTL-83513
CONNECTORS

Rectangular
Micro-D connectors

M83513/13 (continued)

MIL STANDARD	AXON' EQUIVALENT	MIL STANDARD	AXON' EQUIVALENT	MIL STANDARD	AXON' EQUIVALENT
M83513/13-E03CW	MDA131SCBRWG3	M83513/13-F01NW	MDA237SCBRWG1	M83513/13-F02PW	MDAS37SCBRWG2
M83513/13-E03NN	MDA231SCBRBG3	M83513/13-F01PN	MDAS37SCBRBG1	M83513/13-F03CN	MDA137SCBRBG3
M83513/13-E03NP	MDA231SCBRPG3	M83513/13-F01PP	MDAS37SCBRPG1	M83513/13-F03CP	MDA137SCBRPG3
M83513/13-E03NT	MDA231SCBRTG3	M83513/13-F01PT	MDAS37SCBRTG1	M83513/13-F03CT	MDA137SCBRTG3
M83513/13-E03NW	MDA231SCBRWG3	M83513/13-F01PW	MDAS37SCBRWG1	M83513/13-F03CW	MDA137SCBRWG3
M83513/13-E03PN	MDAS31SCBRBG3	M83513/13-F02CN	MDA137SCBRBG2	M83513/13-F03NN	MDA237SCBRBG3
M83513/13-E03PP	MDAS31SCBRPG3	M83513/13-F02CP	MDA137SCBRPG2	M83513/13-F03NP	MDA237SCBRPG3
M83513/13-E03PT	MDAS31SCBRTG3	M83513/13-F02CT	MDA137SCBRTG2	M83513/13-F03NT	MDA237SCBRTG3
M83513/13-E03PW	MDAS31SCBRWG3	M83513/13-F02CW	MDA137SCBRWG2	M83513/13-F03NW	MDA237SCBRWG3
M83513/13-F01CN	MDA137SCBRBG1	M83513/13-F02NN	MDA237SCBRBG2	M83513/13-F03PN	MDAS37SCBRBG3
M83513/13-F01CP	MDA137SCBRPG1	M83513/13-F02NP	MDA237SCBRPG2	M83513/13-F03PP	MDAS37SCBRPG3
M83513/13-F01CT	MDA137SCBRTG1	M83513/13-F02NT	MDA237SCBRTG2	M83513/13-F03PT	MDAS37SCBRTG3
M83513/13-F01CW	MDA137SCBRWG1	M83513/13-F02NW	MDA237SCBRWG2	M83513/13-F03PW	MDAS37SCBRWG3
M83513/13-F01NN	MDA237SCBRBG1	M83513/13-F02PN	MDAS37SCBRBG2		
M83513/13-F01NP	MDA237SCBRPG1	M83513/13-F02PP	MDAS37SCBRPG2		
M83513/13-F01NT	MDA237SCBRTG1	M83513/13-F02PT	MDAS37SCBRTG2		

M83513/14

MIL STANDARD	AXON' EQUIVALENT	MIL STANDARD	AXON' EQUIVALENT	MIL STANDARD	AXON' EQUIVALENT
M83513/14-G01CN	MDA151SCBRBG1	M83513/14-G02CN	MDA151SCBRBG2	M83513/14-G03CN	MDA151SCBRBG3
M83513/14-G01CP	MDA151SCBRPG1	M83513/14-G02CP	MDA151SCBRPG2	M83513/14-G03CP	MDA151SCBRPG3
M83513/14-G01CT	MDA151SCBRTG1	M83513/14-G02CT	MDA151SCBRTG2	M83513/14-G03CT	MDA151SCBRTG3
M83513/14-G01CW	MDA151SCBRWG1	M83513/14-G02CW	MDA151SCBRWG2	M83513/14-G03CW	MDA151SCBRWG3
M83513/14-G01NN	MDA251SCBRBG1	M83513/14-G02NN	MDA251SCBRBG2	M83513/14-G03NN	MDA251SCBRBG3
M83513/14-G01NP	MDA251SCBRPG1	M83513/14-G02NP	MDA251SCBRPG2	M83513/14-G03NP	MDA251SCBRPG3
M83513/14-G01NT	MDA251SCBRTG1	M83513/14-G02NT	MDA251SCBRTG2	M83513/14-G03NT	MDA251SCBRTG3
M83513/14-G01NW	MDA251SCBRWG1	M83513/14-G02NW	MDA251SCBRWG2	M83513/14-G03NW	MDA251SCBRWG3
M83513/14-G01PN	MDAS51SCBRBG1	M83513/14-G02PN	MDAS51SCBRBG2	M83513/14-G03PN	MDAS51SCBRBG3
M83513/14-G01PP	MDAS51SCBRPG1	M83513/14-G02PP	MDAS51SCBRPG2	M83513/14-G03PP	MDAS51SCBRPG3
M83513/14-G01PT	MDAS51SCBRTG1	M83513/14-G02PT	MDAS51SCBRTG2	M83513/14-G03PT	MDAS51SCBRTG3
M83513/14-G01PW	MDAS51SCBRWG1	M83513/14-G02PW	MDAS51SCBRWG2	M83513/14-G03PW	MDAS51SCBRWG3

M83513/15

MIL STANDARD	AXON' EQUIVALENT	MIL STANDARD	AXON' EQUIVALENT	MIL STANDARD	AXON' EQUIVALENT
M83513/15-H01CN	MDA1100SCBRBG1	M83513/15-H02CN	MDA1100SCBRBG2	M83513/15-H03CN	MDA1100SCBRBG3
M83513/15-H01CP	MDA1100SCBRPG1	M83513/15-H02CP	MDA1100SCBRPG2	M83513/15-H03CP	MDA1100SCBRPG3
M83513/15-H01CU	MDA1100SCBRTG1	M83513/15-H02CU	MDA1100SCBRTG2	M83513/15-H03CU	MDA1100SCBRTG3
M83513/15-H01CY	MDA1100SCBRWG1	M83513/15-H02CY	MDA1100SCBRWG2	M83513/15-H03CY	MDA1100SCBRWG3
M83513/15-H01NN	MDA2100SCBRBG1	M83513/15-H02NN	MDA2100SCBRBG2	M83513/15-H03NN	MDA2100SCBRBG3
M83513/15-H01NP	MDA2100SCBRPG1	M83513/15-H02NP	MDA2100SCBRPG2	M83513/15-H03NP	MDA2100SCBRPG3
M83513/15-H01NU	MDA2100SCBRTG1	M83513/15-H02NU	MDA2100SCBRTG2	M83513/15-H03NU	MDA2100SCBRTG3
M83513/15-H01NY	MDA2100SCBRWG1	M83513/15-H02NY	MDA2100SCBRWG2	M83513/15-H03NY	MDA2100SCBRWG3
M83513/15-H01PN	MDAS100SCBRBG1	M83513/15-H02PN	MDAS100SCBRBG2	M83513/15-H03PN	MDAS100SCBRBG3
M83513/15-H01PP	MDAS100SCBRPG1	M83513/15-H02PP	MDAS100SCBRPG2	M83513/15-H03PP	MDAS100SCBRPG3
M83513/15-H01PU	MDAS100SCBRTG1	M83513/15-H02PU	MDAS100SCBRTG2	M83513/15-H03PU	MDAS100SCBRTG3
M83513/15-H01PY	MDAS100SCBRWG1	M83513/15-H02PY	MDAS100SCBRWG2	M83513/15-H03PY	MDAS100SCBRWG3

MIL-DTL-83513
CONNECTORS

Rectangular
Micro-D connectors

M83513/16

MIL STANDARD	AXON' EQUIVALENT	MIL STANDARD	AXON' EQUIVALENT	MIL STANDARD	AXON' EQUIVALENT
M83513/16-A01CN	MDA109PBRBG1	M83513/16-B02PP	MDAS15PBRPG2	M83513/16-D01NT	MDA225PBRTG1
M83513/16-A01CP	MDA109PBRPG1	M83513/16-B02PT	MDAS15PBRTG2	M83513/16-D01NW	MDA225PBRWG1
M83513/16-A01CT	MDA109PBRTG1	M83513/16-B02PW	MDAS15PBRWG2	M83513/16-D01PN	MDAS25PBRBG1
M83513/16-A01CW	MDA109PBRWG1	M83513/16-B03CN	MDA115PBRBG3	M83513/16-D01PP	MDAS25PBRPG1
M83513/16-A01NN	MDA209PBRBG1	M83513/16-B03CP	MDA115PBRPG3	M83513/16-D01PT	MDAS25PBRTG1
M83513/16-A01NP	MDA209PBRPG1	M83513/16-B03CT	MDA115PBRTG3	M83513/16-D01PW	MDAS25PBRWG1
M83513/16-A01NT	MDA209PBRTG1	M83513/16-B03CW	MDA115PBRWG3	M83513/16-D02CN	MDA125PBRBG2
M83513/16-A01NW	MDA209PBRWG1	M83513/16-B03NN	MDA215PBRBG3	M83513/16-D02CP	MDA125PBRPG2
M83513/16-A01PN	MDAS09PBRBG1	M83513/16-B03NP	MDA215PBRPG3	M83513/16-D02CT	MDA125PBRTG2
M83513/16-A01PP	MDAS09PBRPG1	M83513/16-B03NT	MDA215PBRTG3	M83513/16-D02CW	MDA125PBRWG2
M83513/16-A01PT	MDAS09PBRTG1	M83513/16-B03NW	MDA215PBRWG3	M83513/16-D02NN	MDA225PBRBG2
M83513/16-A01PW	MDAS09PBRWG1	M83513/16-B03PN	MDAS15PBRBG3	M83513/16-D02NP	MDAS25PBRPG2
M83513/16-A02CN	MDA109PBRBG2	M83513/16-B03PP	MDAS15PBRPG3	M83513/16-D02NT	MDA225PBRTG2
M83513/16-A02CP	MDA109PBRPG2	M83513/16-B03PT	MDAS15PBRTG3	M83513/16-D02NW	MDA225PBRWG2
M83513/16-A02CT	MDA109PBRTG2	M83513/16-B03PW	MDAS15PBRWG3	M83513/16-D02PN	MDAS25PBRBG2
M83513/16-A02CW	MDA109PBRWG2	M83513/16-C01CN	MDA121PBRBG1	M83513/16-D02PP	MDAS25PBRPG2
M83513/16-A02NN	MDA209PBRBG2	M83513/16-C01CP	MDA121PBRPG1	M83513/16-D02PT	MDAS25PBRTG2
M83513/16-A02NP	MDA209PBRPG2	M83513/16-C01CT	MDA121PBRTG1	M83513/16-D02PW	MDAS25PBRWG2
M83513/16-A02NT	MDA209PBRTG2	M83513/16-C01CW	MDA121PBRWG1	M83513/16-D03CN	MDA125PBRBG3
M83513/16-A02NW	MDA209PBRWG2	M83513/16-C01NN	MDA221PBRBG1	M83513/16-D03CP	MDA125PBRPG3
M83513/16-A02PN	MDAS09PBRBG2	M83513/16-C01NP	MDA221PBRPG1	M83513/16-D03CT	MDA125PBRTG3
M83513/16-A02PP	MDAS09PBRPG2	M83513/16-C01NT	MDA221PBRTG1	M83513/16-D03CW	MDA125PBRWG3
M83513/16-A02PT	MDAS09PBRTG2	M83513/16-C01NW	MDA221PBRWG1	M83513/16-D03NN	MDA225PBRBG3
M83513/16-A02PW	MDAS09PBRWG2	M83513/16-C01PN	MDAS21PBRBG1	M83513/16-D03NP	MDA225PBRPG3
M83513/16-A03CN	MDA109PBRBG3	M83513/16-C01PP	MDAS21PBRPG1	M83513/16-D03NT	MDA225PBRTG3
M83513/16-A03CP	MDA109PBRPG3	M83513/16-C01PT	MDAS21PBRTG1	M83513/16-D03NW	MDA225PBRWG3
M83513/16-A03CT	MDA109PBRTG3	M83513/16-C01PW	MDAS21PBRWG1	M83513/16-D03PN	MDAS25PBRBG3
M83513/16-A03CW	MDA109PBRWG3	M83513/16-C02CN	MDA121PBRBG2	M83513/16-D03PP	MDAS25PBRPG3
M83513/16-A03NN	MDA209PBRBG3	M83513/16-C02CP	MDA121PBRPG2	M83513/16-D03PT	MDAS25PBRTG3
M83513/16-A03NP	MDA209PBRPG3	M83513/16-C02CT	MDA121PBRTG2	M83513/16-D03PW	MDAS25PBRWG3
M83513/16-A03NT	MDA209PBRTG3	M83513/16-C02CW	MDA121PBRWG2	M83513/16-E01CN	MDA131PBRBG1
M83513/16-A03NW	MDA209PBRWG3	M83513/16-C02NN	MDA221PBRBG2	M83513/16-E01CP	MDA131PBRPG1
M83513/16-A03PN	MDAS09PBRBG3	M83513/16-C02NP	MDA221PBRPG2	M83513/16-E01CT	MDA131PBRTG1
M83513/16-A03PP	MDAS09PBRPG3	M83513/16-C02NT	MDA221PBRTG2	M83513/16-E01CW	MDA131PBRWG1
M83513/16-A03PT	MDAS09PBRTG3	M83513/16-C02NW	MDA221PBRWG2	M83513/16-E01NN	MDA231PBRBG1
M83513/16-A03PW	MDAS09PBRWG3	M83513/16-C02PN	MDAS21PBRBG2	M83513/16-E01NP	MDA231PBRPG1
M83513/16-B01CN	MDA115PBRBG1	M83513/16-C02PP	MDAS21PBRPG2	M83513/16-E01NT	MDA231PBRTG1
M83513/16-B01CP	MDA115PBRPG1	M83513/16-C02PT	MDAS21PBRTG2	M83513/16-E01NW	MDA231PBRWG1
M83513/16-B01CT	MDA115PBRTG1	M83513/16-C02PW	MDAS21PBRWG2	M83513/16-E01PN	MDAS31PBRBG1
M83513/16-B01CW	MDA115PBRWG1	M83513/16-C03CN	MDA121PBRBG3	M83513/16-E01PP	MDAS31PBRPG1
M83513/16-B01NN	MDA215PBRBG1	M83513/16-C03CP	MDA121PBRPG3	M83513/16-E01PT	MDAS31PBRTG1
M83513/16-B01NP	MDA215PBRPG1	M83513/16-C03CT	MDA121PBRTG3	M83513/16-E01PW	MDAS31PBRWG1
M83513/16-B01NT	MDA215PBRTG1	M83513/16-C03CW	MDA121PBRWG3	M83513/16-E02CN	MDA131PBRBG2
M83513/16-B01NW	MDA215PBRWG1	M83513/16-C03NN	MDA221PBRBG3	M83513/16-E02CP	MDA131PBRPG2
M83513/16-B01PN	MDAS15PBRBG1	M83513/16-C03NP	MDA221PBRPG3	M83513/16-E02CT	MDA131PBRTG2
M83513/16-B01PP	MDAS15PBRPG1	M83513/16-C03NT	MDA221PBRTG3	M83513/16-E02CW	MDA131PBRWG2
M83513/16-B01PT	MDAS15PBRTG1	M83513/16-C03NW	MDA221PBRWG3	M83513/16-E02NN	MDA231PBRBG2
M83513/16-B01PW	MDAS15PBRWG1	M83513/16-C03PN	MDAS21PBRBG3	M83513/16-E02NP	MDA231PBRPG2
M83513/16-B02CN	MDA115PBRBG2	M83513/16-C03PP	MDAS21PBRPG3	M83513/16-E02NT	MDA231PBRTG2
M83513/16-B02CP	MDA115PBRPG2	M83513/16-C03PT	MDAS21PBRTG3	M83513/16-E02NW	MDA231PBRWG2
M83513/16-B02CT	MDA115PBRTG2	M83513/16-C03PW	MDAS21PBRWG3	M83513/16-E02PN	MDAS31PBRBG2
M83513/16-B02CW	MDA115PBRWG2	M83513/16-D01CN	MDA125PBRBG1	M83513/16-E02PP	MDAS31PBRPG2
M83513/16-B02NN	MDA215PBRBG2	M83513/16-D01CP	MDA125PBRPG1	M83513/16-E02PT	MDAS31PBRTG2
M83513/16-B02NP	MDA215PBRPG2	M83513/16-D01CT	MDA125PBRTG1	M83513/16-E02PW	MDAS31PBRWG2
M83513/16-B02NT	MDA215PBRTG2	M83513/16-D01CW	MDA125PBRWG1	M83513/16-E03CN	MDA131PBRBG3
M83513/16-B02NW	MDA215PBRWG2	M83513/16-D01NN	MDA225PBRBG1	M83513/16-E03CP	MDA131PBRPG3
M83513/16-B02PN	MDAS15PBRBG2	M83513/16-D01NP	MDA225PBRPG1	M83513/16-E03CT	MDA131PBRTG3

MIL-DTL-83513
CONNECTORS

Rectangular
Micro-D connectors

M83513/16 (continued)

MIL STANDARD	AXON' EQUIVALENT	MIL STANDARD	AXON' EQUIVALENT	MIL STANDARD	AXON' EQUIVALENT
M83513/16-E03CW	MDA131PBRWG3	M83513/16-F01NT	MDA237PBRGT1	M83513/16-F02PP	MDAS37PBRPG2
M83513/16-E03NN	MDA231PBRBG3	M83513/16-F01NW	MDA237PBRWG1	M83513/16-F02PT	MDAS37PBRGT2
M83513/16-E03NP	MDA231PBRPG3	M83513/16-F01PN	MDAS37PBRBG1	M83513/16-F02PW	MDAS37PBRWG2
M83513/16-E03NT	MDA231PBRGT3	M83513/16-F01PP	MDAS37PBRPG1	M83513/16-F03CN	MDA137PBRBG3
M83513/16-E03NW	MDA231PBRWG3	M83513/16-F01PT	MDAS37PBRGT1	M83513/16-F03CP	MDA137PBRPG3
M83513/16-E03PN	MDAS31PBRBG3	M83513/16-F01PW	MDAS37PBRWG1	M83513/16-F03CT	MDA137PBRGT3
M83513/16-E03PP	MDAS31PBRPG3	M83513/16-F02CN	MDA137PBRBG2	M83513/16-F03CW	MDA137PBRWG3
M83513/16-E03PT	MDAS31PBRGT3	M83513/16-F02CP	MDA137PBRPG2	M83513/16-F03NN	MDA237PBRBG3
M83513/16-E03PW	MDAS31PBRWG3	M83513/16-F02CT	MDA137PBRGT2	M83513/16-F03NP	MDA237PBRPG3
M83513/16-F01CN	MDA137PBRBG1	M83513/16-F02CW	MDA137PBRWG2	M83513/16-F03NT	MDA237PBRGT3
M83513/16-F01CP	MDA137PBRPG1	M83513/16-F02NN	MDA237PBRBG2	M83513/16-F03NW	MDA237PBRWG3
M83513/16-F01CT	MDA137PBRGT1	M83513/16-F02NP	MDA237PBRPG2	M83513/16-F03PN	MDAS37PBRBG3
M83513/16-F01CW	MDA137PBRWG1	M83513/16-F02NT	MDA237PBRGT2	M83513/16-F03PP	MDAS37PBRPG3
M83513/16-F01NN	MDA237PBRBG1	M83513/16-F02NW	MDA237PBRWG2	M83513/16-F03PT	MDAS37PBRGT3
M83513/16-F01NP	MDA237PBRPG1	M83513/16-F02PN	MDAS37PBRBG2	M83513/16-F03PW	MDAS37PBRWG3

M83513/17

MIL STANDARD	AXON' EQUIVALENT	MIL STANDARD	AXON' EQUIVALENT	MIL STANDARD	AXON' EQUIVALENT
M83513/17-G01CN	MDA151PBRBG1	M83513/17-G02CN	MDA151PBRBG2	M83513/17-G03CN	MDA151PBRBG3
M83513/17-G01CP	MDA151PBRPG1	M83513/17-G02CP	MDA151PBRPG2	M83513/17-G03CP	MDA151PBRPG3
M83513/17-G01CT	MDA151PBRGT1	M83513/17-G02CT	MDA151PBRGT2	M83513/17-G03CT	MDA151PBRGT3
M83513/17-G01CW	MDA151PBRWG1	M83513/17-G02CW	MDA151PBRWG2	M83513/17-G03CW	MDA151PBRWG3
M83513/17-G01NN	MDA251PBRBG1	M83513/17-G02NN	MDA251PBRBG2	M83513/17-G03NN	MDA251PBRBG3
M83513/17-G01NP	MDA251PBRPG1	M83513/17-G02NP	MDA251PBRPG2	M83513/17-G03NP	MDA251PBRPG3
M83513/17-G01NT	MDA251PBRGT1	M83513/17-G02NT	MDA251PBRGT2	M83513/17-G03NT	MDA251PBRGT3
M83513/17-G01NW	MDA251PBRWG1	M83513/17-G02NW	MDA251PBRWG2	M83513/17-G03NW	MDA251PBRWG3
M83513/17-G01PN	MDAS51PBRBG1	M83513/17-G02PN	MDAS51PBRBG2	M83513/17-G03PN	MDAS51PBRBG3
M83513/17-G01PP	MDAS51PBRPG1	M83513/17-G02PP	MDAS51PBRPG2	M83513/17-G03PP	MDAS51PBRPG3
M83513/17-G01PT	MDAS51PBRGT1	M83513/17-G02PT	MDAS51PBRGT2	M83513/17-G03PT	MDAS51PBRGT3
M83513/17-G01PW	MDAS51PBRWG1	M83513/17-G02PW	MDAS51PBRWG2	M83513/17-G03PW	MDAS51PBRWG3

M83513/18

MIL STANDARD	AXON' EQUIVALENT	MIL STANDARD	AXON' EQUIVALENT	MIL STANDARD	AXON' EQUIVALENT
M83513/18-H01CN	MDA1100PBRBG1	M83513/18-H02CN	MDA1100PBRBG2	M83513/18-H03CN	MDA1100PBRBG3
M83513/18-H01CP	MDA1100PBRPG1	M83513/18-H02CP	MDA1100PBRPG2	M83513/18-H03CP	MDA1100PBRPG3
M83513/18-H01CU	MDA1100PBRGT1	M83513/18-H02CU	MDA1100PBRGT2	M83513/18-H03CU	MDA1100PBRGT3
M83513/18-H01CY	MDA1100PBRWG1	M83513/18-H02CY	MDA1100PBRWG2	M83513/18-H03CY	MDA1100PBRWG3
M83513/18-H01NN	MDA2100PBRBG1	M83513/18-H02NN	MDA2100PBRBG2	M83513/18-H03NN	MDA2100PBRBG3
M83513/18-H01NP	MDA2100PBRPG1	M83513/18-H02NP	MDA2100PBRPG2	M83513/18-H03NP	MDA2100PBRPG3
M83513/18-H01NU	MDA2100PBRGT1	M83513/18-H02NU	MDA2100PBRGT2	M83513/18-H03NU	MDA2100PBRGT3
M83513/18-H01NY	MDA2100PBRWG1	M83513/18-H02NY	MDA2100PBRWG2	M83513/18-H03NY	MDA2100PBRWG3
M83513/18-H01PN	MDAS100PBRBG1	M83513/18-H02PN	MDAS100PBRBG2	M83513/18-H03PN	MDAS100PBRBG3
M83513/18-H01PP	MDAS100PBRPG1	M83513/18-H02PP	MDAS100PBRPG2	M83513/18-H03PP	MDAS100PBRPG3
M83513/18-H01PU	MDAS100PBRGT1	M83513/18-H02PU	MDAS100PBRGT2	M83513/18-H03PU	MDAS100PBRGT3
M83513/18-H01PY	MDAS100PBRWG1	M83513/18-H02PY	MDAS100PBRWG2	M83513/18-H03PY	MDAS100PBRWG3

M83513/19

MIL STANDARD	AXON' EQUIVALENT	MIL STANDARD	AXON' EQUIVALENT	MIL STANDARD	AXON' EQUIVALENT
M83513/19-A01CN	MDA109SBRBG1	M83513/19-B02PP	MDAS15SBRPG2	M83513/19-D01NT	MDA225SBRBG1
M83513/19-A01CP	MDA109SBRPG1	M83513/19-B02PT	MDAS15SBRBG2	M83513/19-D01NW	MDA225SBRWG1
M83513/19-A01CT	MDA109SBRTG1	M83513/19-B02PW	MDAS15SBRWG2	M83513/19-D01PN	MDAS25SBRBG1
M83513/19-A01CW	MDA109SBRWG1	M83513/19-B03CN	MDA115SBRBG3	M83513/19-D01PP	MDAS25SBRPG1
M83513/19-A01NN	MDA209SBRBG1	M83513/19-B03CP	MDA115SBRPG3	M83513/19-D01PT	MDAS25SBRBG1
M83513/19-A01NP	MDA209SBRPG1	M83513/19-B03CT	MDA115SBRBG3	M83513/19-D01PW	MDAS25SBRWG1
M83513/19-A01NT	MDA209SBRTG1	M83513/19-B03CW	MDA115SBRWG3	M83513/19-D02CN	MDA125SBRBG2
M83513/19-A01NW	MDA209SBRWG1	M83513/19-B03NN	MDA215SBRBG3	M83513/19-D02CP	MDA125SBRPG2
M83513/19-A01PN	MDAS09SBRBG1	M83513/19-B03NP	MDA215SBRPG3	M83513/19-D02CT	MDA125SBRBG2
M83513/19-A01PP	MDAS09SBRPG1	M83513/19-B03NT	MDA215SBRBG3	M83513/19-D02CW	MDA125SBRWG2
M83513/19-A01PT	MDAS09SBRTG1	M83513/19-B03NW	MDA215SBRWG3	M83513/19-D02NN	MDA225SBRBG2
M83513/19-A01PW	MDAS09SBRWG1	M83513/19-B03PN	MDAS15SBRBG3	M83513/19-D02NP	MDA225SBRPG2
M83513/19-A02CN	MDA109SBRBG2	M83513/19-B03PP	MDAS15SBRPG3	M83513/19-D02NT	MDA225SBRBG2
M83513/19-A02CP	MDA109SBRPG2	M83513/19-B03PT	MDAS15SBRBG3	M83513/19-D02NW	MDA225SBRWG2
M83513/19-A02CT	MDA109SBRTG2	M83513/19-B03PW	MDAS15SBRWG3	M83513/19-D02PN	MDAS25SBRBG2
M83513/19-A02CW	MDA109SBRWG2	M83513/19-C01CN	MDA121SBRBG1	M83513/19-D02PP	MDAS25SBRPG2
M83513/19-A02NN	MDA209SBRBG2	M83513/19-C01CP	MDA121SBRPG1	M83513/19-D02PT	MDAS25SBRBG2
M83513/19-A02NP	MDA209SBRPG2	M83513/19-C01CT	MDA121SBRTG1	M83513/19-D02PW	MDAS25SBRWG2
M83513/19-A02NT	MDA209SBRTG2	M83513/19-C01CW	MDA121SBRWG1	M83513/19-D03CN	MDA125SBRBG3
M83513/19-A02NW	MDA209SBRWG2	M83513/19-C01NN	MDA221SBRBG1	M83513/19-D03CP	MDA125SBRPG3
M83513/19-A02PN	MDAS09SBRBG2	M83513/19-C01NP	MDA221SBRPG1	M83513/19-D03CT	MDA125SBRBG3
M83513/19-A02PP	MDAS09SBRPG2	M83513/19-C01NT	MDA221SBRTG1	M83513/19-D03CW	MDA125SBRWG3
M83513/19-A02PT	MDAS09SBRTG2	M83513/19-C01NW	MDA221SBRWG1	M83513/19-D03NN	MDA225SBRBG3
M83513/19-A02PW	MDAS09SBRWG2	M83513/19-C01PN	MDAS21SBRBG1	M83513/19-D03NP	MDA225SBRPG3
M83513/19-A03CN	MDA109SBRBG3	M83513/19-C01PP	MDAS21SBRPG1	M83513/19-D03NT	MDA225SBRBG3
M83513/19-A03CP	MDA109SBRPG3	M83513/19-C01PT	MDAS21SBRTG1	M83513/19-D03NW	MDA225SBRWG3
M83513/19-A03CT	MDA109SBRTG3	M83513/19-C01PW	MDAS21SBRWG1	M83513/19-D03PN	MDAS25SBRBG3
M83513/19-A03CW	MDA109SBRWG3	M83513/19-C02CN	MDA121SBRBG2	M83513/19-D03PP	MDAS25SBRPG3
M83513/19-A03NN	MDA209SBRBG3	M83513/19-C02CP	MDA121SBRPG2	M83513/19-D03PT	MDAS25SBRBG3
M83513/19-A03NP	MDA209SBRPG3	M83513/19-C02CT	MDA121SBRTG2	M83513/19-D03PW	MDAS25SBRWG3
M83513/19-A03NT	MDA209SBRTG3	M83513/19-C02CW	MDA121SBRWG2	M83513/19-E01CN	MDA131SBRBG1
M83513/19-A03NW	MDA209SBRWG3	M83513/19-C02NN	MDA221SBRBG2	M83513/19-E01CP	MDA131SBRPG1
M83513/19-A03PN	MDAS09SBRBG3	M83513/19-C02NP	MDA221SBRPG2	M83513/19-E01CT	MDA131SBRTG1
M83513/19-A03PP	MDAS09SBRPG3	M83513/19-C02NT	MDA221SBRTG2	M83513/19-E01CW	MDA131SBRWG1
M83513/19-A03PT	MDAS09SBRTG3	M83513/19-C02NW	MDA221SBRWG2	M83513/19-E01NN	MDA231SBRBG1
M83513/19-A03PW	MDAS09SBRWG3	M83513/19-C02PN	MDAS21SBRBG2	M83513/19-E01NP	MDA231SBRPG1
M83513/19-B01CN	MDA115SBRBG1	M83513/19-C02PP	MDAS21SBRPG2	M83513/19-E01NT	MDA231SBRTG1
M83513/19-B01CP	MDA115SBRPG1	M83513/19-C02PT	MDAS21SBRTG2	M83513/19-E01NW	MDA231SBRWG1
M83513/19-B01CT	MDA115SBRTG1	M83513/19-C02PW	MDAS21SBRWG2	M83513/19-E01PN	MDAS31SBRBG1
M83513/19-B01CW	MDA115SBRWG1	M83513/19-C03CN	MDA121SBRBG3	M83513/19-E01PP	MDAS31SBRPG1
M83513/19-B01NN	MDA215SBRBG1	M83513/19-C03CP	MDA121SBRPG3	M83513/19-E01PT	MDAS31SBRTG1
M83513/19-B01NP	MDA215SBRPG1	M83513/19-C03CT	MDA121SBRTG3	M83513/19-E01PW	MDAS31SBRWG1
M83513/19-B01NT	MDA215SBRTG1	M83513/19-C03CW	MDA121SBRWG3	M83513/19-E02CN	MDA131SBRBG2
M83513/19-B01NW	MDA215SBRWG1	M83513/19-C03NN	MDA221SBRBG3	M83513/19-E02CP	MDA131SBRPG2
M83513/19-B01PN	MDAS15SBRBG1	M83513/19-C03NP	MDA221SBRPG3	M83513/19-E02CT	MDA131SBRTG2
M83513/19-B01PP	MDAS15SBRPG1	M83513/19-C03NT	MDA221SBRTG3	M83513/19-E02CW	MDA131SBRWG2
M83513/19-B01PT	MDAS15SBRTG1	M83513/19-C03NW	MDA221SBRWG3	M83513/19-E02NN	MDA231SBRBG2
M83513/19-B01PW	MDAS15SBRWG1	M83513/19-C03PN	MDAS21SBRBG3	M83513/19-E02NP	MDA231SBRPG2
M83513/19-B02CN	MDA115SBRBG2	M83513/19-C03PP	MDAS21SBRPG3	M83513/19-E02NT	MDA231SBRTG2
M83513/19-B02CP	MDA115SBRPG2	M83513/19-C03PT	MDAS21SBRTG3	M83513/19-E02NW	MDA231SBRWG2
M83513/19-B02CT	MDA115SBRTG2	M83513/19-C03PW	MDAS21SBRWG3	M83513/19-E02PN	MDAS31SBRBG2
M83513/19-B02CW	MDA115SBRWG2	M83513/19-D01CN	MDA125SBRBG1	M83513/19-E02PP	MDAS31SBRPG2
M83513/19-B02NN	MDA215SBRBG2	M83513/19-D01CP	MDA125SBRPG1	M83513/19-E02PT	MDAS31SBRTG2
M83513/19-B02NP	MDA215SBRPG2	M83513/19-D01CT	MDA125SBRTG1	M83513/19-E02PW	MDAS31SBRWG2
M83513/19-B02NT	MDA215SBRTG2	M83513/19-D01CW	MDA125SBRWG1	M83513/19-E03CN	MDA131SBRBG3
M83513/19-B02NW	MDA215SBRWG2	M83513/19-D01NN	MDA225SBRBG1	M83513/19-E03CP	MDA131SBRPG3
M83513/19-B02PN	MDAS15SBRBG2	M83513/19-D01NP	MDA225SBRPG1	M83513/19-E03CT	MDA131SBRTG3

MIL-DTL-83513
CONNECTORS

Rectangular
Micro-D connectors

M83513/19 (continued)

MIL STANDARD	AXON' EQUIVALENT	MIL STANDARD	AXON' EQUIVALENT	MIL STANDARD	AXON' EQUIVALENT
M83513/19-E03CW	MDA131SBRWG3	M83513/19-F01NW	MDA237SBRWG1	M83513/19-F02PW	MDAS37SBRWG2
M83513/19-E03NN	MDA231SBRBG3	M83513/19-F01PN	MDAS37SBRBG1	M83513/19-F03CN	MDA137SBRBG3
M83513/19-E03NP	MDA231SBRPG3	M83513/19-F01PP	MDAS37SBRPG1	M83513/19-F03CP	MDA137SBRPG3
M83513/19-E03NT	MDA231SBRTG3	M83513/19-F01PT	MDAS37SBRTG1	M83513/19-F03CT	MDA137SBRTG3
M83513/19-E03NW	MDA231SBRWG3	M83513/19-F01PW	MDAS37SBRWG1	M83513/19-F03CW	MDA137SBRWG3
M83513/19-E03PN	MDAS31SBRBG3	M83513/19-F02CN	MDA137SBRBG2	M83513/19-F03NN	MDA237SBRBG3
M83513/19-E03PP	MDAS31SBRPG3	M83513/19-F02CP	MDA137SBRPG2	M83513/19-F03NP	MDA237SBRPG3
M83513/19-E03PT	MDAS31SBRTG3	M83513/19-F02CT	MDA137SBRTG2	M83513/19-F03NT	MDA237SBRTG3
M83513/19-E03PW	MDAS31SBRWG3	M83513/19-F02CW	MDA137SBRWG2	M83513/19-F03NW	MDA237SBRWG3
M83513/19-F01CN	MDA137SBRBG1	M83513/19-F02NN	MDA237SBRBG2	M83513/19-F03PN	MDAS37SBRBG3
M83513/19-F01CP	MDA137SBRPG1	M83513/19-F02NP	MDA237SBRPG2	M83513/19-F03PP	MDAS37SBRPG3
M83513/19-F01CT	MDA137SBRTG1	M83513/19-F02NT	MDA237SBRTG2	M83513/19-F03PT	MDAS37SBRTG3
M83513/19-F01CW	MDA137SBRWG1	M83513/19-F02NW	MDA237SBRWG2	M83513/19-F03PW	MDAS37SBRWG3
M83513/19-F01NN	MDA237SBRBG1	M83513/19-F02PN	MDAS37SBRBG2		
M83513/19-F01NP	MDA237SBRPG1	M83513/19-F02PP	MDAS37SBRPG2		
M83513/19-F01NT	MDA237SBRTG1	M83513/19-F02PT	MDAS37SBRTG2		

M83513/20

MIL STANDARD	AXON' EQUIVALENT	MIL STANDARD	AXON' EQUIVALENT	MIL STANDARD	AXON' EQUIVALENT
M83513/20-G01CN	MDA151SBRBG1	M83513/20-G02CN	MDA151SBRBG2	M83513/20-G03CN	MDA151SBRBG3
M83513/20-G01CP	MDA151SBRPG1	M83513/20-G02CP	MDA151SBRPG2	M83513/20-G03CP	MDA151SBRPG3
M83513/20-G01CT	MDA151SBRTG1	M83513/20-G02CT	MDA151SBRTG2	M83513/20-G03CT	MDA151SBRTG3
M83513/20-G01CW	MDA151SBRWG1	M83513/20-G02CW	MDA151SBRWG2	M83513/20-G03CW	MDA151SBRWG3
M83513/20-G01NN	MDA251SBRBG1	M83513/20-G02NN	MDA251SBRBG2	M83513/20-G03NN	MDA251SBRBG3
M83513/20-G01NP	MDA251SBRPG1	M83513/20-G02NP	MDA251SBRPG2	M83513/20-G03NP	MDA251SBRPG3
M83513/20-G01NT	MDA251SBRTG1	M83513/20-G02NT	MDA251SBRTG2	M83513/20-G03NT	MDA251SBRTG3
M83513/20-G01NW	MDA251SBRWG1	M83513/20-G02NW	MDA251SBRWG2	M83513/20-G03NW	MDA251SBRWG3
M83513/20-G01PN	MDAS51SBRBG1	M83513/20-G02PN	MDAS51SBRBG2	M83513/20-G03PN	MDAS51SBRBG3
M83513/20-G01PP	MDAS51SBRPG1	M83513/20-G02PP	MDAS51SBRPG2	M83513/20-G03PP	MDAS51SBRPG3
M83513/20-G01PT	MDAS51SBRTG1	M83513/20-G02PT	MDAS51SBRTG2	M83513/20-G03PT	MDAS51SBRTG3
M83513/20-G01PW	MDAS51SBRWG1	M83513/20-G02PW	MDAS51SBRWG2	M83513/20-G03PW	MDAS51SBRWG3

M83513/21

MIL STANDARD	AXON' EQUIVALENT	MIL STANDARD	AXON' EQUIVALENT	MIL STANDARD	AXON' EQUIVALENT
M83513/21-H01CN	MDA1100SBRBG1	M83513/21-H02CN	MDA1100SBRBG2	M83513/21-H03CN	MDA1100SBRBG3
M83513/21-H01CP	MDA1100SBRPG1	M83513/21-H02CP	MDA1100SBRPG2	M83513/21-H03CP	MDA1100SBRPG3
M83513/21-H01CU	MDA1100SBRTG1	M83513/21-H02CU	MDA1100SBRTG2	M83513/21-H03CU	MDA1100SBRTG3
M83513/21-H01CY	MDA1100SBRWG1	M83513/21-H02CY	MDA1100SBRWG2	M83513/21-H03CY	MDA1100SBRWG3
M83513/21-H01NN	MDA2100SBRBG1	M83513/21-H02NN	MDA2100SBRBG2	M83513/21-H03NN	MDA2100SBRBG3
M83513/21-H01NP	MDA2100SBRPG1	M83513/21-H02NP	MDA2100SBRPG2	M83513/21-H03NP	MDA2100SBRPG3
M83513/21-H01NU	MDA2100SBRTG1	M83513/21-H02NU	MDA2100SBRTG2	M83513/21-H03NU	MDA2100SBRTG3
M83513/21-H01NY	MDA2100SBRWG1	M83513/21-H02NY	MDA2100SBRWG2	M83513/21-H03NY	MDA2100SBRWG3
M83513/21-H01PN	MDAS100SBRBG1	M83513/21-H02PN	MDAS100SBRBG2	M83513/21-H03PN	MDAS100SBRBG3
M83513/21-H01PP	MDAS100SBRPG1	M83513/21-H02PP	MDAS100SBRPG2	M83513/21-H03PP	MDAS100SBRPG3
M83513/21-H01PU	MDAS100SBRTG1	M83513/21-H02PU	MDAS100SBRTG2	M83513/21-H03PU	MDAS100SBRTG3
M83513/21-H01PY	MDAS100SBRWG1	M83513/21-H02PY	MDAS100SBRWG2	M83513/21-H03PY	MDAS100SBRWG3

MIL-DTL-83513
CONNECTORS

Rectangular
Micro-D connectors

M83513/22

MIL STANDARD	AXON' EQUIVALENT	MIL STANDARD	AXON' EQUIVALENT	MIL STANDARD	AXON' EQUIVALENT
M83513/22-A01CN	MDA109PBSBG1	M83513/22-B02PP	MDAS15PBSBG2	M83513/22-D01NT	MDA225PBSTG1
M83513/22-A01CP	MDA109PBSPG1	M83513/22-B02PT	MDAS15PBSTG2	M83513/22-D01NW	MDA225PBSWG1
M83513/22-A01CT	MDA109PBSTG1	M83513/22-B02PW	MDAS15PBSWG2	M83513/22-D01PN	MDAS25PBSBG1
M83513/22-A01CW	MDA109PBSWG1	M83513/22-B03CN	MDA115PBSBG3	M83513/22-D01PP	MDAS25PBSPG1
M83513/22-A01NN	MDA209PBSBG1	M83513/22-B03CP	MDA115PBSPG3	M83513/22-D01PT	MDAS25PBSTG1
M83513/22-A01NP	MDA209PBSPG1	M83513/22-B03CT	MDA115PBSTG3	M83513/22-D01PW	MDAS25PBSWG1
M83513/22-A01NT	MDA209PBSTG1	M83513/22-B03CW	MDA115PBSWG3	M83513/22-D02CN	MDA125PBSBG2
M83513/22-A01NW	MDA209PBSWG1	M83513/22-B03NN	MDA215PBSBG3	M83513/22-D02CP	MDA125PBSPG2
M83513/22-A01PN	MDAS09PBSBG1	M83513/22-B03NP	MDA215PBSPG3	M83513/22-D02CT	MDA125PBSTG2
M83513/22-A01PP	MDAS09PBSPG1	M83513/22-B03NT	MDA215PBSTG3	M83513/22-D02CW	MDA125PBSWG2
M83513/22-A01PT	MDAS09PBSTG1	M83513/22-B03NW	MDA215PBSWG3	M83513/22-D02NN	MDA225PBSBG2
M83513/22-A01PW	MDAS09PBSWG1	M83513/22-B03PN	MDAS15PBSBG3	M83513/22-D02NP	MDA225PBSPG2
M83513/22-A02CN	MDA109PBSBG2	M83513/22-B03PP	MDAS15PBSPG3	M83513/22-D02NT	MDA225PBSTG2
M83513/22-A02CP	MDA109PBSPG2	M83513/22-B03PT	MDAS15PBSTG3	M83513/22-D02NW	MDA225PBSWG2
M83513/22-A02CT	MDA109PBSTG2	M83513/22-B03PW	MDAS15PBSWG3	M83513/22-D02PN	MDAS25PBSBG2
M83513/22-A02CW	MDA109PBSWG2	M83513/22-C01CN	MDA121PBSBG1	M83513/22-D02PP	MDAS25PBSPG2
M83513/22-A02NN	MDA209PBSBG2	M83513/22-C01CP	MDA121PBSPG1	M83513/22-D02PT	MDAS25PBSTG2
M83513/22-A02NP	MDA209PBSPG2	M83513/22-C01CT	MDA121PBSTG1	M83513/22-D02PW	MDAS25PBSWG2
M83513/22-A02NT	MDA209PBSTG2	M83513/22-C01CW	MDA121PBSWG1	M83513/22-D03CN	MDA125PBSBG3
M83513/22-A02NW	MDA209PBSWG2	M83513/22-C01NN	MDA221PBSBG1	M83513/22-D03CP	MDA125PBSPG3
M83513/22-A02PN	MDAS09PBSBG2	M83513/22-C01NP	MDA221PBSPG1	M83513/22-D03CT	MDA125PBSTG3
M83513/22-A02PP	MDAS09PBSPG2	M83513/22-C01NT	MDA221PBSTG1	M83513/22-D03CW	MDA125PBSWG3
M83513/22-A02PT	MDAS09PBSTG2	M83513/22-C01NW	MDA221PBSWG1	M83513/22-D03NN	MDA225PBSBG3
M83513/22-A02PW	MDAS09PBSWG2	M83513/22-C01PN	MDAS21PBSBG1	M83513/22-D03NP	MDA225PBSPG3
M83513/22-A03CN	MDA109PBSBG3	M83513/22-C01PP	MDAS21PBSPG1	M83513/22-D03NT	MDA225PBSTG3
M83513/22-A03CP	MDA109PBSPG3	M83513/22-C01PT	MDAS21PBSTG1	M83513/22-D03NW	MDA225PBSWG3
M83513/22-A03CT	MDA109PBSTG3	M83513/22-C01PW	MDAS21PBSWG1	M83513/22-D03PN	MDAS25PBSBG3
M83513/22-A03CW	MDA109PBSWG3	M83513/22-C02CN	MDA121PBSBG2	M83513/22-D03PP	MDAS25PBSPG3
M83513/22-A03NN	MDA209PBSBG3	M83513/22-C02CP	MDA121PBSPG2	M83513/22-D03PT	MDAS25PBSTG3
M83513/22-A03NP	MDA209PBSPG3	M83513/22-C02CT	MDA121PBSTG2	M83513/22-D03PW	MDAS25PBSWG3
M83513/22-A03NT	MDA209PBSTG3	M83513/22-C02CW	MDA121PBSWG2	M83513/22-E01CN	MDA131PBSBG1
M83513/22-A03NW	MDA209PBSWG3	M83513/22-C02NN	MDA221PBSBG2	M83513/22-E01CP	MDA131PBSPG1
M83513/22-A03PN	MDAS09PBSBG3	M83513/22-C02NP	MDA221PBSPG2	M83513/22-E01CT	MDA131PBSTG1
M83513/22-A03PP	MDAS09PBSPG3	M83513/22-C02NT	MDA221PBSTG2	M83513/22-E01CW	MDA131PBSWG1
M83513/22-A03PT	MDAS09PBSTG3	M83513/22-C02NW	MDA221PBSWG2	M83513/22-E01NN	MDA231PBSBG1
M83513/22-A03PW	MDAS09PBSWG3	M83513/22-C02PN	MDAS21PBSBG2	M83513/22-E01NP	MDA231PBSPG1
M83513/22-B01CN	MDA115PBSBG1	M83513/22-C02PP	MDAS21PBSPG2	M83513/22-E01NT	MDA231PBSTG1
M83513/22-B01CP	MDA115PBSPG1	M83513/22-C02PT	MDAS21PBSTG2	M83513/22-E01NW	MDA231PBSWG1
M83513/22-B01CT	MDA115PBSTG1	M83513/22-C02PW	MDAS21PBSWG2	M83513/22-E01PN	MDAS31PBSBG1
M83513/22-B01CW	MDA115PBSWG1	M83513/22-C03CN	MDA121PBSBG3	M83513/22-E01PP	MDAS31PBSPG1
M83513/22-B01NN	MDA215PBSBG1	M83513/22-C03CP	MDA121PBSPG3	M83513/22-E01PT	MDAS31PBSTG1
M83513/22-B01NP	MDA215PBSPG1	M83513/22-C03CT	MDA121PBSTG3	M83513/22-E01PW	MDAS31PBSWG1
M83513/22-B01NT	MDA215PBSTG1	M83513/22-C03CW	MDA121PBSWG3	M83513/22-E02CN	MDA131PBSBG2
M83513/22-B01NW	MDA215PBSWG1	M83513/22-C03NN	MDA221PBSBG3	M83513/22-E02CP	MDA131PBSPG2
M83513/22-B01PN	MDAS15PBSBG1	M83513/22-C03NP	MDA221PBSPG3	M83513/22-E02CT	MDA131PBSTG2
M83513/22-B01PP	MDAS15PBSPG1	M83513/22-C03NT	MDA221PBSTG3	M83513/22-E02CW	MDA131PBSWG2
M83513/22-B01PT	MDAS15PBSTG1	M83513/22-C03NW	MDA221PBSWG3	M83513/22-E02NN	MDA231PBSBG2
M83513/22-B01PW	MDAS15PBSWG1	M83513/22-C03PN	MDAS21PBSBG3	M83513/22-E02NP	MDA231PBSPG2
M83513/22-B02CN	MDA115PBSBG2	M83513/22-C03PP	MDAS21PBSPG3	M83513/22-E02NT	MDA231PBSTG2
M83513/22-B02CP	MDA115PBSPG2	M83513/22-C03PT	MDAS21PBSTG3	M83513/22-E02NW	MDA231PBSWG2
M83513/22-B02CT	MDA115PBSTG2	M83513/22-C03PW	MDAS21PBSWG3	M83513/22-E02PN	MDAS31PBSBG2
M83513/22-B02CW	MDA115PBSWG2	M83513/22-D01CN	MDA125PBSBG1	M83513/22-E02PP	MDAS31PBSPG2
M83513/22-B02NN	MDA215PBSBG2	M83513/22-D01CP	MDA125PBSPG1	M83513/22-E02PT	MDAS31PBSTG2
M83513/22-B02NP	MDA215PBSPG2	M83513/22-D01CT	MDA125PBSTG1	M83513/22-E02PW	MDAS31PBSWG2
M83513/22-B02NT	MDA215PBSTG2	M83513/22-D01CW	MDA125PBSWG1	M83513/22-E03CN	MDA131PBSBG3
M83513/22-B02NW	MDA215PBSWG2	M83513/22-D01NN	MDA225PBSBG1	M83513/22-E03CP	MDA131PBSPG3
M83513/22-B02PN	MDAS15PBSBG2	M83513/22-D01NP	MDA225PBSPG1	M83513/22-E03CT	MDA131PBSTG3

MIL-DTL-83513
CONNECTORS

Rectangular
Micro-D connectors

M83513/22 (continued)

MIL STANDARD	AXON' EQUIVALENT	MIL STANDARD	AXON' EQUIVALENT	MIL STANDARD	AXON' EQUIVALENT
M83513/22-E03CW	MDA131PBSWG3	M83513/22-F01NW	MDA237PBSWG1	M83513/22-F02PW	MDAS37PBSWG2
M83513/22-E03NN	MDA231PBSBG3	M83513/22-F01PN	MDAS37PBSBG1	M83513/22-F03CN	MDA137PBSBG3
M83513/22-E03NP	MDA231PBSPG3	M83513/22-F01PP	MDAS37PBSPG1	M83513/22-F03CP	MDA137PBSPG3
M83513/22-E03NT	MDA231PBSTG3	M83513/22-F01PT	MDAS37PBSTG1	M83513/22-F03CT	MDA137PBSTG3
M83513/22-E03NW	MDA231PBSWG3	M83513/22-F01PW	MDAS37PBSWG1	M83513/22-F03CW	MDA137PBSWG3
M83513/22-E03PN	MDAS31PBSBG3	M83513/22-F02CN	MDA137PBSBG2	M83513/22-F03NN	MDA237PBSBG3
M83513/22-E03PP	MDAS31PBSPG3	M83513/22-F02CP	MDA137PBSPG2	M83513/22-F03NP	MDA237PBSPG3
M83513/22-E03PT	MDAS31PBSTG3	M83513/22-F02CT	MDA137PBSTG2	M83513/22-F03NT	MDA237PBSTG3
M83513/22-E03PW	MDAS31PBSWG3	M83513/22-F02CW	MDA137PBSWG2	M83513/22-F03NW	MDA237PBSWG3
M83513/22-F01CN	MDA137PBSBG1	M83513/22-F02NN	MDA237PBSBG2	M83513/22-F03PN	MDAS37PBSBG3
M83513/22-F01CP	MDA137PBSPG1	M83513/22-F02NP	MDA237PBSPG2	M83513/22-F03PP	MDAS37PBSPG3
M83513/22-F01CT	MDA137PBSTG1	M83513/22-F02NT	MDA237PBSTG2	M83513/22-F03PT	MDAS37PBSTG3
M83513/22-F01CW	MDA137PBSWG1	M83513/22-F02NW	MDA237PBSWG2	M83513/22-F03PW	MDAS37PBSWG3
M83513/22-F01NN	MDA237PBSBG1	M83513/22-F02PN	MDAS37PBSBG2		
M83513/22-F01NP	MDA237PBSPG1	M83513/22-F02PP	MDAS37PBSPG2		
M83513/22-F01NT	MDA237PBSTG1	M83513/22-F02PT	MDAS37PBSTG2		

M83513/23

MIL STANDARD	AXON' EQUIVALENT	MIL STANDARD	AXON' EQUIVALENT	MIL STANDARD	AXON' EQUIVALENT
M83513/23-G01CN	MDA151PBSBG1	M83513/23-G02CN	MDA151PBSBG2	M83513/23-G03CN	MDA151PBSBG3
M83513/23-G01CP	MDA151PBSPG1	M83513/23-G02CP	MDA151PBSPG2	M83513/23-G03CP	MDA151PBSPG3
M83513/23-G01CT	MDA151PBSTG1	M83513/23-G02CT	MDA151PBSTG2	M83513/23-G03CT	MDA151PBSTG3
M83513/23-G01CW	MDA151PBSWG1	M83513/23-G02CW	MDA151PBSWG2	M83513/23-G03CW	MDA151PBSWG3
M83513/23-G01NN	MDA251PBSBG1	M83513/23-G02NN	MDA251PBSBG2	M83513/23-G03NN	MDA251PBSBG3
M83513/23-G01NP	MDA251PBSPG1	M83513/23-G02NP	MDA251PBSPG2	M83513/23-G03NP	MDA251PBSPG3
M83513/23-G01NT	MDA251PBSTG1	M83513/23-G02NT	MDA251PBSTG2	M83513/23-G03NT	MDA251PBSTG3
M83513/23-G01NW	MDA251PBSWG1	M83513/23-G02NW	MDA251PBSWG2	M83513/23-G03NW	MDA251PBSWG3
M83513/23-G01PN	MDAS51PBSBG1	M83513/23-G02PN	MDAS51PBSBG2	M83513/23-G03PN	MDAS51PBSBG3
M83513/23-G01PP	MDAS51PBSPG1	M83513/23-G02PP	MDAS51PBSPG2	M83513/23-G03PP	MDAS51PBSPG3
M83513/23-G01PT	MDAS51PBSTG1	M83513/23-G02PT	MDAS51PBSTG2	M83513/23-G03PT	MDAS51PBSTG3
M83513/23-G01PW	MDAS51PBSWG1	M83513/23-G02PW	MDAS51PBSWG2	M83513/23-G03PW	MDAS51PBSWG3

M83513/24

MIL STANDARD	AXON' EQUIVALENT	MIL STANDARD	AXON' EQUIVALENT	MIL STANDARD	AXON' EQUIVALENT
M83513/24-H01CN	MDA1100PBSBG1	M83513/24-H02CN	MDA1100PBSBG2	M83513/24-H03CN	MDA1100PBSBG3
M83513/24-H01CP	MDA1100PBSPG1	M83513/24-H02CP	MDA1100PBSPG2	M83513/24-H03CP	MDA1100PBSPG3
M83513/24-H01CU	MDA1100PBSTG1	M83513/24-H02CU	MDA1100PBSTG2	M83513/24-H03CU	MDA1100PBSTG3
M83513/24-H01CY	MDA1100PBSWG1	M83513/24-H02CY	MDA1100PBSWG2	M83513/24-H03CY	MDA1100PBSWG3
M83513/24-H01NN	MDA2100PBSBG1	M83513/24-H02NN	MDA2100PBSBG2	M83513/24-H03NN	MDA2100PBSBG3
M83513/24-H01NP	MDA2100PBSPG1	M83513/24-H02NP	MDA2100PBSPG2	M83513/24-H03NP	MDA2100PBSPG3
M83513/24-H01NU	MDA2100PBSTG1	M83513/24-H02NU	MDA2100PBSTG2	M83513/24-H03NU	MDA2100PBSTG3
M83513/24-H01NY	MDA2100PBSWG1	M83513/24-H02NY	MDA2100PBSWG2	M83513/24-H03NY	MDA2100PBSWG3
M83513/24-H01PN	MDAS100PBSBG1	M83513/24-H02PN	MDAS100PBSBG2	M83513/24-H03PN	MDAS100PBSBG3
M83513/24-H01PP	MDAS100PBSPG1	M83513/24-H02PP	MDAS100PBSPG2	M83513/24-H03PP	MDAS100PBSPG3
M83513/24-H01PU	MDAS100PBSTG1	M83513/24-H02PU	MDAS100PBSTG2	M83513/24-H03PU	MDAS100PBSTG3
M83513/24-H01PY	MDAS100PBSWG1	M83513/24-H02PY	MDAS100PBSWG2	M83513/24-H03PY	MDAS100PBSWG3

M83513/25

MIL STANDARD	AXON' EQUIVALENT	MIL STANDARD	AXON' EQUIVALENT	MIL STANDARD	AXON' EQUIVALENT
M83513/25-A01CN	MDA109SBSBG1	M83513/25-B02PP	MDAS15SBSBG2	M83513/25-D01NT	MDA225SBSTG1
M83513/25-A01CP	MDA109SBSPG1	M83513/25-B02PT	MDAS15SBSTG2	M83513/25-D01NW	MDA225SBSWG1
M83513/25-A01CT	MDA109SBSTG1	M83513/25-B02PW	MDAS15SBSWG2	M83513/25-D01PN	MDAS25SBSBG1
M83513/25-A01CW	MDA109SBSWG1	M83513/25-B03CN	MDA115SBSBG3	M83513/25-D01PP	MDAS25SBSPG1
M83513/25-A01NN	MDA209SBSBG1	M83513/25-B03CP	MDA115SBSPG3	M83513/25-D01PT	MDAS25SBSTG1
M83513/25-A01NP	MDA209SBSPG1	M83513/25-B03CT	MDA115SBSTG3	M83513/25-D01PW	MDAS25SBSWG1
M83513/25-A01NT	MDA209SBSTG1	M83513/25-B03CW	MDA115SBSWG3	M83513/25-D02CN	MDA125SBSBG2
M83513/25-A01NW	MDA209SBSWG1	M83513/25-B03NN	MDA215SBSBG3	M83513/25-D02CP	MDA125SBSPG2
M83513/25-A01PN	MDAS09SBSBG1	M83513/25-B03NP	MDA215SBSPG3	M83513/25-D02CT	MDA125SBSTG2
M83513/25-A01PP	MDAS09SBSPG1	M83513/25-B03NT	MDA215SBSTG3	M83513/25-D02CW	MDA125SBSWG2
M83513/25-A01PT	MDAS09SBSTG1	M83513/25-B03NW	MDA215SBSWG3	M83513/25-D02NN	MDA225SBSBG2
M83513/25-A01PW	MDAS09SBSWG1	M83513/25-B03PN	MDAS15SBSBG3	M83513/25-D02NP	MDA225SBSPG2
M83513/25-A02CN	MDA109SBSBG2	M83513/25-B03PP	MDAS15SBSPG3	M83513/25-D02NT	MDA225SBSTG2
M83513/25-A02CP	MDA109SBSPG2	M83513/25-B03PT	MDAS15SBSTG3	M83513/25-D02NW	MDA225SBSWG2
M83513/25-A02CT	MDA109SBSTG2	M83513/25-B03PW	MDAS15SBSWG3	M83513/25-D02PN	MDAS25SBSBG2
M83513/25-A02CW	MDA109SBSWG2	M83513/25-C01CN	MDA121SBSBG1	M83513/25-D02PP	MDAS25SBSPG2
M83513/25-A02NN	MDA209SBSBG2	M83513/25-C01CP	MDA121SBSPG1	M83513/25-D02PT	MDAS25SBSTG2
M83513/25-A02NP	MDA209SBSPG2	M83513/25-C01CT	MDA121SBSTG1	M83513/25-D02PW	MDAS25SBSWG2
M83513/25-A02NT	MDA209SBSTG2	M83513/25-C01CW	MDA121SBSWG1	M83513/25-D03CN	MDA125SBSBG3
M83513/25-A02NW	MDA209SBSWG2	M83513/25-C01NN	MDA221SBSBG1	M83513/25-D03CP	MDA125SBSPG3
M83513/25-A02PN	MDAS09SBSBG2	M83513/25-C01NP	MDA221SBSPG1	M83513/25-D03CT	MDA125SBSTG3
M83513/25-A02PP	MDAS09SBSPG2	M83513/25-C01NT	MDA221SBSTG1	M83513/25-D03CW	MDA125SBSWG3
M83513/25-A02PT	MDAS09SBSTG2	M83513/25-C01NW	MDA221SBSWG1	M83513/25-D03NN	MDA225SBSBG3
M83513/25-A02PW	MDAS09SBSWG2	M83513/25-C01PN	MDAS21SBSBG1	M83513/25-D03NP	MDA225SBSPG3
M83513/25-A03CN	MDA109SBSBG3	M83513/25-C01PP	MDAS21SBSPG1	M83513/25-D03NT	MDA225SBSTG3
M83513/25-A03CP	MDA109SBSPG3	M83513/25-C01PT	MDAS21SBSTG1	M83513/25-D03NW	MDA225SBSWG3
M83513/25-A03CT	MDA109SBSTG3	M83513/25-C01PW	MDAS21SBSWG1	M83513/25-D03PN	MDAS25SBSBG3
M83513/25-A03CW	MDA109SBSWG3	M83513/25-C02CN	MDA121SBSBG2	M83513/25-D03PP	MDAS25SBSPG3
M83513/25-A03NN	MDA209SBSBG3	M83513/25-C02CP	MDA121SBSPG2	M83513/25-D03PT	MDAS25SBSTG3
M83513/25-A03NP	MDA209SBSPG3	M83513/25-C02CT	MDA121SBSTG2	M83513/25-D03PW	MDAS25SBSWG3
M83513/25-A03NT	MDA209SBSTG3	M83513/25-C02CW	MDA121SBSWG2	M83513/25-E01CN	MDA131SBSBG1
M83513/25-A03NW	MDA209SBSWG3	M83513/25-C02NN	MDA221SBSBG2	M83513/25-E01CP	MDA131SBSPG1
M83513/25-A03PN	MDAS09SBSBG3	M83513/25-C02NP	MDA221SBSPG2	M83513/25-E01CT	MDA131SBSTG1
M83513/25-A03PP	MDAS09SBSPG3	M83513/25-C02NT	MDA221SBSTG2	M83513/25-E01CW	MDA131SBSWG1
M83513/25-A03PT	MDAS09SBSTG3	M83513/25-C02NW	MDA221SBSWG2	M83513/25-E01NN	MDA231SBSBG1
M83513/25-A03PW	MDAS09SBSWG3	M83513/25-C02PN	MDAS21SBSBG2	M83513/25-E01NP	MDA231SBSPG1
M83513/25-B01CN	MDA115SBSBG1	M83513/25-C02PP	MDAS21SBSPG2	M83513/25-E01NT	MDA231SBSTG1
M83513/25-B01CP	MDA115SBSPG1	M83513/25-C02PT	MDAS21SBSTG2	M83513/25-E01NW	MDA231SBSWG1
M83513/25-B01CT	MDA115SBSTG1	M83513/25-C02PW	MDAS21SBSWG2	M83513/25-E01PN	MDAS31SBSBG1
M83513/25-B01CW	MDA115SBSWG1	M83513/25-C03CN	MDA121SBSBG3	M83513/25-E01PP	MDAS31SBSPG1
M83513/25-B01NN	MDA215SBSBG1	M83513/25-C03CP	MDA121SBSPG3	M83513/25-E01PT	MDAS31SBSTG1
M83513/25-B01NP	MDA215SBSPG1	M83513/25-C03CT	MDA121SBSTG3	M83513/25-E01PW	MDAS31SBSWG1
M83513/25-B01NT	MDA215SBSTG1	M83513/25-C03CW	MDA121SBSWG3	M83513/25-E02CN	MDA131SBSBG2
M83513/25-B01NW	MDA215SBSWG1	M83513/25-C03NN	MDA221SBSBG3	M83513/25-E02CP	MDA131SBSPG2
M83513/25-B01PN	MDAS15SBSBG1	M83513/25-C03NP	MDA221SBSPG3	M83513/25-E02CT	MDA131SBSTG2
M83513/25-B01PP	MDAS15SBSPG1	M83513/25-C03NT	MDA221SBSTG3	M83513/25-E02CW	MDA131SBSWG2
M83513/25-B01PT	MDAS15SBSTG1	M83513/25-C03NW	MDA221SBSWG3	M83513/25-E02NN	MDA231SBSBG2
M83513/25-B01PW	MDAS15SBSWG1	M83513/25-C03PN	MDAS21SBSBG3	M83513/25-E02NP	MDA231SBSPG2
M83513/25-B02CN	MDA115SBSBG2	M83513/25-C03PP	MDAS21SBSPG3	M83513/25-E02NT	MDA231SBSTG2
M83513/25-B02CP	MDA115SBSPG2	M83513/25-C03PT	MDAS21SBSTG3	M83513/25-E02NW	MDA231SBSWG2
M83513/25-B02CT	MDA115SBSTG2	M83513/25-C03PW	MDAS21SBSWG3	M83513/25-E02PN	MDAS31SBSBG2
M83513/25-B02CW	MDA115SBSWG2	M83513/25-D01CN	MDA125SBSBG1	M83513/25-E02PP	MDAS31SBSPG2
M83513/25-B02NN	MDA215SBSBG2	M83513/25-D01CP	MDA125SBSPG1	M83513/25-E02PT	MDAS31SBSTG2
M83513/25-B02NP	MDA215SBSPG2	M83513/25-D01CT	MDA125SBSTG1	M83513/25-E02PW	MDAS31SBSWG2
M83513/25-B02NT	MDA215SBSTG2	M83513/25-D01CW	MDA125SBSWG1	M83513/25-E03CN	MDA131SBSBG3
M83513/25-B02NW	MDA215SBSWG2	M83513/25-D01NN	MDA225SBSBG1	M83513/25-E03CP	MDA131SBSPG3
M83513/25-B02PN	MDAS15SBSBG2	M83513/25-D01NP	MDA225SBSPG1	M83513/25-E03CT	MDA131SBSTG3

MIL-DTL-83513
CONNECTORS

Rectangular
Micro-D connectors

M83513/25 (continued)

MIL STANDARD	AXON' EQUIVALENT	MIL STANDARD	AXON' EQUIVALENT	MIL STANDARD	AXON' EQUIVALENT
M83513/25-E03CW	MDA131SBSWG3	M83513/25-F01NT	MDA237SBSTG1	M83513/25-F02PP	MDAS37SBSBG2
M83513/25-E03NN	MDA231SBSBG3	M83513/25-F01NW	MDA237SBSWG1	M83513/25-F02PT	MDAS37SBSTG2
M83513/25-E03NP	MDA231SBSBG3	M83513/25-F01PN	MDAS37SBSBG1	M83513/25-F02PW	MDAS37SBSWG2
M83513/25-E03NT	MDA231SBSTG3	M83513/25-F01PP	MDAS37SBSBG1	M83513/25-F03CN	MDA137SBSBG3
M83513/25-E03NW	MDA231SBSWG3	M83513/25-F01PT	MDAS37SBSTG1	M83513/25-F03CP	MDA137SBSBG3
M83513/25-E03PN	MDAS31SBSBG3	M83513/25-F01PW	MDAS37SBSWG1	M83513/25-F03CT	MDA137SBSTG3
M83513/25-E03PP	MDAS31SBSBG3	M83513/25-F02CN	MDA137SBSBG2	M83513/25-F03CW	MDA137SBSWG3
M83513/25-E03PT	MDAS31SBSTG3	M83513/25-F02CP	MDA137SBSBG2	M83513/25-F03NN	MDA237SBSBG3
M83513/25-E03PW	MDAS31SBSWG3	M83513/25-F02CT	MDA137SBSTG2	M83513/25-F03NP	MDA237SBSBG3
M83513/25-F01CN	MDA137SBSBG1	M83513/25-F02CW	MDA137SBSWG2	M83513/25-F03NT	MDA237SBSTG3
M83513/25-F01CP	MDA137SBSBG1	M83513/25-F02NN	MDA237SBSBG2	M83513/25-F03NW	MDA237SBSWG3
M83513/25-F01CT	MDA137SBSTG1	M83513/25-F02NP	MDA237SBSBG2	M83513/25-F03PN	MDAS37SBSBG3
M83513/25-F01CW	MDA137SBSWG1	M83513/25-F02NT	MDA237SBSTG2	M83513/25-F03PP	MDAS37SBSBG3
M83513/25-F01NN	MDA237SBSBG1	M83513/25-F02NW	MDA237SBSWG2	M83513/25-F03PT	MDAS37SBSTG3
M83513/25-F01NP	MDA237SBSBG1	M83513/25-F02PN	MDAS37SBSBG2	M83513/25-F03PW	MDAS37SBSWG3

MIL-DTL-83513
CONNECTORS

Rectangular
Micro-D connectors

M83513/26

MIL STANDARD	AXON' EQUIVALENT	MIL STANDARD	AXON' EQUIVALENT	MIL STANDARD	AXON' EQUIVALENT
M83513/26-G01CN	MDA151SBSBG1	M83513/26-G02CN	MDA151SBSBG2	M83513/26-G03CN	MDA151SBSBG3
M83513/26-G01CP	MDA151SBSBG1	M83513/26-G02CP	MDA151SBSBG2	M83513/26-G03CP	MDA151SBSBG3
M83513/26-G01CT	MDA151SBSTG1	M83513/26-G02CT	MDA151SBSTG2	M83513/26-G03CT	MDA151SBSTG3
M83513/26-G01CW	MDA151SBSWG1	M83513/26-G02CW	MDA151SBSWG2	M83513/26-G03CW	MDA151SBSWG3
M83513/26-G01NN	MDA251SBSBG1	M83513/26-G02NN	MDA251SBSBG2	M83513/26-G03NN	MDA251SBSBG3
M83513/26-G01NP	MDA251SBSBG1	M83513/26-G02NP	MDA251SBSBG2	M83513/26-G03NP	MDA251SBSBG3
M83513/26-G01NT	MDA251SBSTG1	M83513/26-G02NT	MDA251SBSTG2	M83513/26-G03NT	MDA251SBSTG3
M83513/26-G01NW	MDA251SBSWG1	M83513/26-G02NW	MDA251SBSWG2	M83513/26-G03NW	MDA251SBSWG3
M83513/26-G01PN	MDAS51SBSBG1	M83513/26-G02PN	MDAS51SBSBG2	M83513/26-G03PN	MDAS51SBSBG3
M83513/26-G01PP	MDAS51SBSBG1	M83513/26-G02PP	MDAS51SBSBG2	M83513/26-G03PP	MDAS51SBSBG3
M83513/26-G01PT	MDAS51SBSTG1	M83513/26-G02PT	MDAS51SBSTG2	M83513/26-G03PT	MDAS51SBSTG3
M83513/26-G01PW	MDAS51SBSWG1	M83513/26-G02PW	MDAS51SBSWG2	M83513/26-G03PW	MDAS51SBSWG3

M83513/27

MIL STANDARD	AXON' EQUIVALENT	MIL STANDARD	AXON' EQUIVALENT	MIL STANDARD	AXON' EQUIVALENT
M83513/27-H01CN	MDA1100SBSBG1	M83513/27-H02CN	MDA1100SBSBG2	M83513/27-H03CN	MDA1100SBSBG3
M83513/27-H01CP	MDA1100SBSBG1	M83513/27-H02CP	MDA1100SBSBG2	M83513/27-H03CP	MDA1100SBSBG3
M83513/27-H01CU	MDA1100SBSTG1	M83513/27-H02CU	MDA1100SBSTG2	M83513/27-H03CU	MDA1100SBSTG3
M83513/27-H01CY	MDA1100SBSWG1	M83513/27-H02CY	MDA1100SBSWG2	M83513/27-H03CY	MDA1100SBSWG3
M83513/27-H01NN	MDA2100SBSBG1	M83513/27-H02NN	MDA2100SBSBG2	M83513/27-H03NN	MDA2100SBSBG3
M83513/27-H01NP	MDA2100SBSBG1	M83513/27-H02NP	MDA2100SBSBG2	M83513/27-H03NP	MDA2100SBSBG3
M83513/27-H01NU	MDA2100SBSTG1	M83513/27-H02NU	MDA2100SBSTG2	M83513/27-H03NU	MDA2100SBSTG3
M83513/27-H01NY	MDA2100SBSWG1	M83513/27-H02NY	MDA2100SBSWG2	M83513/27-H03NY	MDA2100SBSWG3
M83513/27-H01PN	MDAS100SBSBG1	M83513/27-H02PN	MDAS100SBSBG2	M83513/27-H03PN	MDAS100SBSBG3
M83513/27-H01PP	MDAS100SBSBG1	M83513/27-H02PP	MDAS100SBSBG2	M83513/27-H03PP	MDAS100SBSBG3
M83513/27-H01PU	MDAS100SBSTG1	M83513/27-H02PU	MDAS100SBSTG2	M83513/27-H03PU	MDAS100SBSTG3
M83513/27-H01PY	MDAS100SBSWG1	M83513/27-H02PY	MDAS100SBSWG2	M83513/27-H03PY	MDAS100SBSWG3

M83513/28 (continued)

MIL STANDARD	AXON' EQUIVALENT	MIL STANDARD	AXON' EQUIVALENT	MIL STANDARD	AXON' EQUIVALENT
M83513/28-E03CW	MDA131P75SAWG3	M83513/28-F01NW	MDA237P75SAWG1	M83513/28-F02PW	MDAS37P75SAWG2
M83513/28-E03NN	MDA231P75SABG3	M83513/28-F01PN	MDAS37P75SABG1	M83513/28-F03CN	MDA137P75SABG3
M83513/28-E03NP	MDA231P75SAPG3	M83513/28-F01PP	MDAS37P75SAPG1	M83513/28-F03CP	MDA137P75SAPG3
M83513/28-E03NT	MDA231P75SATG3	M83513/28-F01PT	MDAS37P75SATG1	M83513/28-F03CT	MDA137P75SATG3
M83513/28-E03NW	MDA231P75SAWG3	M83513/28-F01PW	MDAS37P75SAWG1	M83513/28-F03CW	MDA137P75SAWG3
M83513/28-E03PN	MDAS31P75SABG3	M83513/28-F02CN	MDA137P75SABG2	M83513/28-F03NN	MDA237P75SABG3
M83513/28-E03PP	MDAS31P75SAPG3	M83513/28-F02CP	MDA137P75SAPG2	M83513/28-F03NP	MDA237P75SAPG3
M83513/28-E03PT	MDAS31P75SATG3	M83513/28-F02CT	MDA137P75SATG2	M83513/28-F03NT	MDA237P75SATG3
M83513/28-E03PW	MDAS31P75SAWG3	M83513/28-F02CW	MDA137P75SAWG2	M83513/28-F03NW	MDA237P75SAWG3
M83513/28-F01CN	MDA137P75SABG1	M83513/28-F02NN	MDA237P75SABG2	M83513/28-F03PN	MDAS37P75SABG3
M83513/28-F01CP	MDA137P75SAPG1	M83513/28-F02NP	MDA237P75SAPG2	M83513/28-F03PP	MDAS37P75SAPG3
M83513/28-F01CT	MDA137P75SATG1	M83513/28-F02NT	MDA237P75SATG2	M83513/28-F03PT	MDAS37P75SATG3
M83513/28-F01CW	MDA137P75SAWG1	M83513/28-F02NW	MDA237P75SAWG2	M83513/28-F03PW	MDAS37P75SAWG3
M83513/28-F01NN	MDA237P75SABG1	M83513/28-F02PN	MDAS37P75SABG2		
M83513/28-F01NP	MDA237P75SAPG1	M83513/28-F02PP	MDAS37P75SAPG2		
M83513/28-F01NT	MDA237P75SATG1	M83513/28-F02PT	MDAS37P75SATG2		

M83513/29

MIL STANDARD	AXON' EQUIVALENT	MIL STANDARD	AXON' EQUIVALENT	MIL STANDARD	AXON' EQUIVALENT
M83513/29-G01CN	MDA151P75SABG1	M83513/29-G02CN	MDA151P75SABG2	M83513/29-G03CN	MDA151P75SABG3
M83513/29-G01CP	MDA151P75SAPG1	M83513/29-G02CP	MDA151P75SAPG2	M83513/29-G03CP	MDA151P75SAPG3
M83513/29-G01CT	MDA151P75SATG1	M83513/29-G02CT	MDA151P75SATG2	M83513/29-G03CT	MDA151P75SATG3
M83513/29-G01CW	MDA151P75SAWG1	M83513/29-G02CW	MDA151P75SAWG2	M83513/29-G03CW	MDA151P75SAWG3
M83513/29-G01NN	MDA251P75SABG1	M83513/29-G02NN	MDA251P75SABG2	M83513/29-G03NN	MDA251P75SABG3
M83513/29-G01NP	MDA251P75SAPG1	M83513/29-G02NP	MDA251P75SAPG2	M83513/29-G03NP	MDA251P75SAPG3
M83513/29-G01NT	MDA251P75SATG1	M83513/29-G02NT	MDA251P75SATG2	M83513/29-G03NT	MDA251P75SATG3
M83513/29-G01NW	MDA251P75SAWG1	M83513/29-G02NW	MDA251P75SAWG2	M83513/29-G03NW	MDA251P75SAWG3
M83513/29-G01PN	MDAS51P75SABG1	M83513/29-G02PN	MDAS51P75SABG2	M83513/29-G03PN	MDAS51P75SABG3
M83513/29-G01PP	MDAS51P75SAPG1	M83513/29-G02PP	MDAS51P75SAPG2	M83513/29-G03PP	MDAS51P75SAPG3
M83513/29-G01PT	MDAS51P75SATG1	M83513/29-G02PT	MDAS51P75SATG2	M83513/29-G03PT	MDAS51P75SATG3
M83513/29-G01PW	MDAS51P75SAWG1	M83513/29-G02PW	MDAS51P75SAWG2	M83513/29-G03PW	MDAS51P75SAWG3

M83513/30

MIL STANDARD	AXON' EQUIVALENT	MIL STANDARD	AXON' EQUIVALENT	MIL STANDARD	AXON' EQUIVALENT
M83513/30-H01CN	MDA1100P75SABG1	M83513/30-H02CN	MDA1100P75SABG2	M83513/30-H03CN	MDA1100P75SABG3
M83513/30-H01CP	MDA1100P75SAPG1	M83513/30-H02CP	MDA1100P75SAPG2	M83513/30-H03CP	MDA1100P75SAPG3
M83513/30-H01CU	MDA1100P75SATG1	M83513/30-H02CU	MDA1100P75SATG2	M83513/30-H03CU	MDA1100P75SATG3
M83513/30-H01CY	MDA1100P75SAWG1	M83513/30-H02CY	MDA1100P75SAWG2	M83513/30-H03CY	MDA1100P75SAWG3
M83513/30-H01NN	MDA2100P75SABG1	M83513/30-H02NN	MDA2100P75SABG2	M83513/30-H03NN	MDA2100P75SABG3
M83513/30-H01NP	MDA2100P75SAPG1	M83513/30-H02NP	MDA2100P75SAPG2	M83513/30-H03NP	MDA2100P75SAPG3
M83513/30-H01NU	MDA2100P75SATG1	M83513/30-H02NU	MDA2100P75SATG2	M83513/30-H03NU	MDA2100P75SATG3
M83513/30-H01NY	MDA2100P75SAWG1	M83513/30-H02NY	MDA2100P75SAWG2	M83513/30-H03NY	MDA2100P75SAWG3
M83513/30-H01PN	MDAS100P75SABG1	M83513/30-H02PN	MDAS100P75SABG2	M83513/30-H03PN	MDAS100P75SABG3
M83513/30-H01PP	MDAS100P75SAPG1	M83513/30-H02PP	MDAS100P75SAPG2	M83513/30-H03PP	MDAS100P75SAPG3
M83513/30-H01PU	MDAS100P75SATG1	M83513/30-H02PU	MDAS100P75SATG2	M83513/30-H03PU	MDAS100P75SATG3
M83513/30-H01PY	MDAS100P75SAWG1	M83513/30-H02PY	MDAS100P75SAWG2	M83513/30-H03PY	MDAS100P75SAWG3

M83513/31

MIL STANDARD	AXON' EQUIVALENT	MIL STANDARD	AXON' EQUIVALENT	MIL STANDARD	AXON' EQUIVALENT
M83513/31-A01CN	MDA109S75SABG1	M83513/31-B02PP	MDAS15S75SAPG2	M83513/31-D01NT	MDA225S75SATG1
M83513/31-A01CP	MDA109S75SAPG1	M83513/31-B02PT	MDAS15S75SATG2	M83513/31-D01NW	MDA225S75SAWG1
M83513/31-A01CT	MDA109S75SATG1	M83513/31-B02PW	MDAS15S75SAWG2	M83513/31-D01PN	MDAS25S75SABG1
M83513/31-A01CW	MDA109S75SAWG1	M83513/31-B03CN	MDA115S75SABG3	M83513/31-D01PP	MDAS25S75SAPG1
M83513/31-A01NN	MDA209S75SABG1	M83513/31-B03CP	MDA115S75SAPG3	M83513/31-D01PT	MDAS25S75SATG1
M83513/31-A01NP	MDA209S75SAPG1	M83513/31-B03CT	MDA115S75SATG3	M83513/31-D01PW	MDAS25S75SAWG1
M83513/31-A01NT	MDA209S75SATG1	M83513/31-B03CW	MDA115S75SAWG3	M83513/31-D02CN	MDA125S75SABG2
M83513/31-A01NW	MDA209S75SAWG1	M83513/31-B03NN	MDA215S75SABG3	M83513/31-D02CP	MDA125S75SAPG2
M83513/31-A01PN	MDAS09S75SABG1	M83513/31-B03NP	MDA215S75SAPG3	M83513/31-D02CT	MDA125S75SATG2
M83513/31-A01PP	MDAS09S75SAPG1	M83513/31-B03NT	MDA215S75SATG3	M83513/31-D02CW	MDA125S75SAWG2
M83513/31-A01PT	MDAS09S75SATG1	M83513/31-B03NW	MDA215S75SAWG3	M83513/31-D02NN	MDA225S75SABG2
M83513/31-A01PW	MDAS09S75SAWG1	M83513/31-B03PN	MDAS15S75SABG3	M83513/31-D02NP	MDA225S75SAPG2
M83513/31-A02CN	MDA109S75SABG2	M83513/31-B03PP	MDAS15S75SAPG3	M83513/31-D02NT	MDA225S75SATG2
M83513/31-A02CP	MDA109S75SAPG2	M83513/31-B03PT	MDAS15S75SATG3	M83513/31-D02NW	MDA225S75SAWG2
M83513/31-A02CT	MDA109S75SATG2	M83513/31-B03PW	MDAS15S75SAWG3	M83513/31-D02PN	MDAS25S75SABG2
M83513/31-A02CW	MDA109S75SAWG2	M83513/31-C01CN	MDA121S75SABG1	M83513/31-D02PP	MDAS25S75SAPG2
M83513/31-A02NN	MDA209S75SABG2	M83513/31-C01CP	MDA121S75SAPG1	M83513/31-D02PT	MDAS25S75SATG2
M83513/31-A02NP	MDA209S75SAPG2	M83513/31-C01CT	MDA121S75SATG1	M83513/31-D02PW	MDAS25S75SAWG2
M83513/31-A02NT	MDA209S75SATG2	M83513/31-C01CW	MDA121S75SAWG1	M83513/31-D03CN	MDA125S75SABG3
M83513/31-A02NW	MDA209S75SAWG2	M83513/31-C01NN	MDA221S75SABG1	M83513/31-D03CP	MDA125S75SAPG3
M83513/31-A02PN	MDAS09S75SABG2	M83513/31-C01NP	MDA221S75SAPG1	M83513/31-D03CT	MDA125S75SATG3
M83513/31-A02PP	MDAS09S75SAPG2	M83513/31-C01NT	MDA221S75SATG1	M83513/31-D03CW	MDA125S75SAWG3
M83513/31-A02PT	MDAS09S75SATG2	M83513/31-C01NW	MDA221S75SAWG1	M83513/31-D03NN	MDA225S75SABG3
M83513/31-A02PW	MDAS09S75SAWG2	M83513/31-C01PN	MDAS21S75SABG1	M83513/31-D03NP	MDA225S75SAPG3
M83513/31-A03CN	MDA109S75SABG3	M83513/31-C01PP	MDAS21S75SAPG1	M83513/31-D03NT	MDA225S75SATG3
M83513/31-A03CP	MDA109S75SAPG3	M83513/31-C01PT	MDAS21S75SATG1	M83513/31-D03NW	MDA225S75SAWG3
M83513/31-A03CT	MDA109S75SATG3	M83513/31-C01PW	MDAS21S75SAWG1	M83513/31-D03PN	MDAS25S75SABG3
M83513/31-A03CW	MDA109S75SAWG3	M83513/31-C02CN	MDA121S75SABG2	M83513/31-D03PP	MDAS25S75SAPG3
M83513/31-A03NN	MDA209S75SABG3	M83513/31-C02CP	MDA121S75SAPG2	M83513/31-D03PT	MDAS25S75SATG3
M83513/31-A03NP	MDA209S75SAPG3	M83513/31-C02CT	MDA121S75SATG2	M83513/31-D03PW	MDAS25S75SAWG3
M83513/31-A03NT	MDA209S75SATG3	M83513/31-C02CW	MDA121S75SAWG2	M83513/31-E01CN	MDA131S75SABG1
M83513/31-A03NW	MDA209S75SAWG3	M83513/31-C02NN	MDA221S75SABG2	M83513/31-E01CP	MDA131S75SAPG1
M83513/31-A03PN	MDAS09S75SABG3	M83513/31-C02NP	MDA221S75SAPG2	M83513/31-E01CT	MDA131S75SATG1
M83513/31-A03PP	MDAS09S75SAPG3	M83513/31-C02NT	MDA221S75SATG2	M83513/31-E01CW	MDA131S75SAWG1
M83513/31-A03PT	MDAS09S75SATG3	M83513/31-C02NW	MDA221S75SAWG2	M83513/31-E01NN	MDA231S75SABG1
M83513/31-A03PW	MDAS09S75SAWG3	M83513/31-C02PN	MDAS21S75SABG2	M83513/31-E01NP	MDA231S75SAPG1
M83513/31-B01CN	MDA115S75SABG1	M83513/31-C02PP	MDAS21S75SAPG2	M83513/31-E01NT	MDA231S75SATG1
M83513/31-B01CP	MDA115S75SAPG1	M83513/31-C02PT	MDAS21S75SATG2	M83513/31-E01NW	MDA231S75SAWG1
M83513/31-B01CT	MDA115S75SATG1	M83513/31-C02PW	MDAS21S75SAWG2	M83513/31-E01PN	MDAS31S75SABG1
M83513/31-B01CW	MDA115S75SAWG1	M83513/31-C03CN	MDA121S75SABG3	M83513/31-E01PP	MDAS31S75SAPG1
M83513/31-B01NN	MDA215S75SABG1	M83513/31-C03CP	MDA121S75SAPG3	M83513/31-E01PT	MDAS31S75SATG1
M83513/31-B01NP	MDA215S75SAPG1	M83513/31-C03CT	MDA121S75SATG3	M83513/31-E01PW	MDAS31S75SAWG1
M83513/31-B01NT	MDA215S75SATG1	M83513/31-C03CW	MDA121S75SAWG3	M83513/31-E02CN	MDA131S75SABG2
M83513/31-B01NW	MDA215S75SAWG1	M83513/31-C03NN	MDA221S75SABG3	M83513/31-E02CP	MDA131S75SAPG2
M83513/31-B01PN	MDAS15S75SABG1	M83513/31-C03NP	MDA221S75SAPG3	M83513/31-E02CT	MDA131S75SATG2
M83513/31-B01PP	MDAS15S75SAPG1	M83513/31-C03NT	MDA221S75SATG3	M83513/31-E02CW	MDA131S75SAWG2
M83513/31-B01PT	MDAS15S75SATG1	M83513/31-C03NW	MDA221S75SAWG3	M83513/31-E02NN	MDA231S75SABG2
M83513/31-B01PW	MDAS15S75SAWG1	M83513/31-C03PN	MDAS21S75SABG3	M83513/31-E02NP	MDA231S75SAPG2
M83513/31-B02CN	MDA115S75SABG2	M83513/31-C03PP	MDAS21S75SAPG3	M83513/31-E02NT	MDA231S75SATG2
M83513/31-B02CP	MDA115S75SAPG2	M83513/31-C03PT	MDAS21S75SATG3	M83513/31-E02NW	MDA231S75SAWG2
M83513/31-B02CT	MDA115S75SATG2	M83513/31-C03PW	MDAS21S75SAWG3	M83513/31-E02PN	MDAS31S75SABG2
M83513/31-B02CW	MDA115S75SAWG2	M83513/31-D01CN	MDA125S75SABG1	M83513/31-E02PP	MDAS31S75SAPG2
M83513/31-B02NN	MDA215S75SABG2	M83513/31-D01CP	MDA125S75SAPG1	M83513/31-E02PT	MDAS31S75SATG2
M83513/31-B02NP	MDA215S75SAPG2	M83513/31-D01CT	MDA125S75SATG1	M83513/31-E02PW	MDAS31S75SAWG2
M83513/31-B02NT	MDA215S75SATG2	M83513/31-D01CW	MDA125S75SAWG1	M83513/31-E03CN	MDA131S75SABG3
M83513/31-B02NW	MDA215S75SAWG2	M83513/31-D01NN	MDA225S75SABG1	M83513/31-E03CP	MDA131S75SAPG3
M83513/31-B02PN	MDAS15S75SABG2	M83513/31-D01NP	MDA225S75SAPG1	M83513/31-E03CT	MDA131S75SATG3

MIL-DTL-83513
CONNECTORS

Rectangular
Micro-D connectors

M83513/31 (continued)

MIL STANDARD	AXON' EQUIVALENT	MIL STANDARD	AXON' EQUIVALENT	MIL STANDARD	AXON' EQUIVALENT
M83513/31-E03CW	MDA131S75SAWG3	M83513/31-F01NW	MDA237S75SAWG1	M83513/31-F02PW	MDAS37S75SAWG2
M83513/31-E03NN	MDA231S75SABG3	M83513/31-F01PN	MDAS37S75SABG1	M83513/31-F03CN	MDA137S75SABG3
M83513/31-E03NP	MDA231S75SAPG3	M83513/31-F01PP	MDAS37S75SAPG1	M83513/31-F03CP	MDA137S75SAPG3
M83513/31-E03NT	MDA231S75SATG3	M83513/31-F01PT	MDAS37S75SATG1	M83513/31-F03CT	MDA137S75SATG3
M83513/31-E03NW	MDA231S75SAWG3	M83513/31-F01PW	MDAS37S75SAWG1	M83513/31-F03CW	MDA137S75SAWG3
M83513/31-E03PN	MDAS31S75SABG3	M83513/31-F02CN	MDA137S75SABG2	M83513/31-F03NN	MDA237S75SABG3
M83513/31-E03PP	MDAS31S75SAPG3	M83513/31-F02CP	MDA137S75SAPG2	M83513/31-F03NP	MDA237S75SAPG3
M83513/31-E03PT	MDAS31S75SATG3	M83513/31-F02CT	MDA137S75SATG2	M83513/31-F03NT	MDA237S75SATG3
M83513/31-E03PW	MDAS31S75SAWG3	M83513/31-F02CW	MDA137S75SAWG2	M83513/31-F03NW	MDA237S75SAWG3
M83513/31-F01CN	MDA137S75SABG1	M83513/31-F02NN	MDA237S75SABG2	M83513/31-F03PN	MDAS37S75SABG3
M83513/31-F01CP	MDA137S75SAPG1	M83513/31-F02NP	MDA237S75SAPG2	M83513/31-F03PP	MDAS37S75SAPG3
M83513/31-F01CT	MDA137S75SATG1	M83513/31-F02NT	MDA237S75SATG2	M83513/31-F03PT	MDAS37S75SATG3
M83513/31-F01CW	MDA137S75SAWG1	M83513/31-F02NW	MDA237S75SAWG2	M83513/31-F03PW	MDAS37S75SAWG3
M83513/31-F01NN	MDA237S75SABG1	M83513/31-F02PN	MDAS37S75SABG2		
M83513/31-F01NP	MDA237S75SAPG1	M83513/31-F02PP	MDAS37S75SAPG2		
M83513/31-F01NT	MDA237S75SATG1	M83513/31-F02PT	MDAS37S75SATG2		

M83513/32

MIL STANDARD	AXON' EQUIVALENT	MIL STANDARD	AXON' EQUIVALENT	MIL STANDARD	AXON' EQUIVALENT
M83513/32-G01CN	MDA151S75SABG1	M83513/32-G02CN	MDA151S75SABG2	M83513/32-G03CN	MDA151S75SABG3
M83513/32-G01CP	MDA151S75SAPG1	M83513/32-G02CP	MDA151S75SAPG2	M83513/32-G03CP	MDA151S75SAPG3
M83513/32-G01CT	MDA151S75SATG1	M83513/32-G02CT	MDA151S75SATG2	M83513/32-G03CT	MDA151S75SATG3
M83513/32-G01CW	MDA151S75SAWG1	M83513/32-G02CW	MDA151S75SAWG2	M83513/32-G03CW	MDA151S75SAWG3
M83513/32-G01NN	MDA251S75SABG1	M83513/32-G02NN	MDA251S75SABG2	M83513/32-G03NN	MDA251S75SABG3
M83513/32-G01NP	MDA251S75SAPG1	M83513/32-G02NP	MDA251S75SAPG2	M83513/32-G03NP	MDA251S75SAPG3
M83513/32-G01NT	MDA251S75SATG1	M83513/32-G02NT	MDA251S75SATG2	M83513/32-G03NT	MDA251S75SATG3
M83513/32-G01NW	MDA251S75SAWG1	M83513/32-G02NW	MDA251S75SAWG2	M83513/32-G03NW	MDA251S75SAWG3
M83513/32-G01PN	MDAS51S75SABG1	M83513/32-G02PN	MDAS51S75SABG2	M83513/32-G03PN	MDAS51S75SABG3
M83513/32-G01PP	MDAS51S75SAPG1	M83513/32-G02PP	MDAS51S75SAPG2	M83513/32-G03PP	MDAS51S75SAPG3
M83513/32-G01PT	MDAS51S75SATG1	M83513/32-G02PT	MDAS51S75SATG2	M83513/32-G03PT	MDAS51S75SATG3
M83513/32-G01PW	MDAS51S75SAWG1	M83513/32-G02PW	MDAS51S75SAWG2	M83513/32-G03PW	MDAS51S75SAWG3

M83513/33

MIL STANDARD	AXON' EQUIVALENT	MIL STANDARD	AXON' EQUIVALENT	MIL STANDARD	AXON' EQUIVALENT
M83513/33-H01CN	MDA1100S75SABG1	M83513/33-H02CN	MDA1100S75SABG2	M83513/33-H03CN	MDA1100S75SABG3
M83513/33-H01CP	MDA1100S75SAPG1	M83513/33-H02CP	MDA1100S75SAPG2	M83513/33-H03CP	MDA1100S75SAPG3
M83513/33-H01CU	MDA1100S75SATG1	M83513/33-H02CU	MDA1100S75SATG2	M83513/33-H03CU	MDA1100S75SATG3
M83513/33-H01CY	MDA1100S75SAWG1	M83513/33-H02CY	MDA1100S75SAWG2	M83513/33-H03CY	MDA1100S75SAWG3
M83513/33-H01NN	MDA2100S75SABG1	M83513/33-H02NN	MDA2100S75SABG2	M83513/33-H03NN	MDA2100S75SABG3
M83513/33-H01NP	MDA2100S75SAPG1	M83513/33-H02NP	MDA2100S75SAPG2	M83513/33-H03NP	MDA2100S75SAPG3
M83513/33-H01NU	MDA2100S75SATG1	M83513/33-H02NU	MDA2100S75SATG2	M83513/33-H03NU	MDA2100S75SATG3
M83513/33-H01NY	MDA2100S75SAWG1	M83513/33-H02NY	MDA2100S75SAWG2	M83513/33-H03NY	MDA2100S75SAWG3
M83513/33-H01PN	MDAS100S75SABG1	M83513/33-H02PN	MDAS100S75SABG2	M83513/33-H03PN	MDAS100S75SABG3
M83513/33-H01PP	MDAS100S75SAPG1	M83513/33-H02PP	MDAS100S75SAPG2	M83513/33-H03PP	MDAS100S75SAPG3
M83513/33-H01PU	MDAS100S75SATG1	M83513/33-H02PU	MDAS100S75SATG2	M83513/33-H03PU	MDAS100S75SATG3
M83513/33-H01PY	MDAS100S75SAWG1	M83513/33-H02PY	MDAS100S75SAWG2	M83513/33-H03PY	MDAS100S75SAWG3

RECTANGULAR MICRO-D CONNECTORS

GENERAL INFORMATION

● Micro-D glossary of terms	22
● D-Line® connector mating guide	23
● Micro-D general characteristics	24
● Micro-D REACH & RoHS compliance	25
● Micro-D contact arrangements	
- Male rectangular connector	26
- Female rectangular connector	27
● Micro-D weights	28
● Micro-D wire codes	29
● Micro-D colour codes	30
● Micro-D rear panel mounting guide	32
● Micro-D front panel mounting guide	33
● Micro-D panel cutouts	34

MIL-DTL-83513

Micro-D QPL - CAGE CODE: OKOJ2

M83513 /01 & /02

● Solder cup connector - Metal shell	38
--	----

M83513 /03 & /04

● Pigtail connector - Metal shell	40
---	----

M83513 /06 & /07

● Solder cup connector - Plastic shell	42
--	----

M83513 /08 & /09

● Pigtail connector - Plastic shell	44
---	----

M83513 /10 TO /15

● PCB connector - Narrow profile - Right angle	
0.100" pitch - Metal shell	46
● PCB layout for QPL narrow profile	48

M83513 /16 TO /21

● PCB connector - Standard profile - Right angle	
0.100" pitch - Metal shell	50
● PCB layout for QPL standard profile	52

M83513 /22 TO /27

● PCB connector - Straight - 0.100" pitch - Metal shell	54
● PCB layout for QPL Straight - 0.100" pitch	56

M83513 /28 TO /33

● PCB connector - Straight - 0.075" pitch - Metal shell	58
● PCB layout for QPL Straight - 0.075" pitch	60

MILITARY CROSS REFERENCE CHART	417
---	------------

PIGTAIL, SOLDER CUP, PCB, SAVERS & MICROSTRIP CONNECTORS

RECTANGULAR CONNECTORS

- Pigtail connector - Metal shell 64
- Pigtail connector - Low profile - Metal shell 66
- Pigtail connector - Plastic shell 68
- Solder cup connector - Metal shell 70
- Solder cup connector - Low profile - Metal shell 72
- Solder cup connector - Plastic shell 74

PCB RECTANGULAR CONNECTORS

- PCB connectors overview 76
- CBR (Condensed Board Right Angle) type - 0.100" pitch
Metal shell 78
- CBR (Condensed Board Right Angle) type - 0.100" pitch
Plastic shell 80
PCB layout for CBR type 82
- CBP (Condensed Board Right Angle) type - 0.100" pitch
Low profile - Metal shell 86
- CBP (Condensed Board Right Angle) type - 0.100" pitch
Low profile - Plastic shell 88
PCB layout for CBP type 90
- BR (Board Right Angle) type - 0.100" pitch - Metal shell 92
PCB layout for BR type 94
- BS (Board Straight) type - 0.100" pitch - Metal shell 98
- BS (Board Straight) type - 0.100" pitch - Plastic shell 100
PCB layout for BS type 102
- CBR (Condensed Board Right Angle) type - 0.075" pitch
Metal shell 106
PCB layout for CBR 0.075" type 108
- CBR (Condensed Board Right Angle) type - 0.075" pitch
Metal shell - Based on BS MIL standard layout 112
PCB layout for CBR 0.075" type
Based on BS MIL standard layout 114
- BS (Board Straight) type - 0.075" pitch - Metal shell 116
- BS (Board Straight) type - 0.075" pitch - Plastic shell 118
PCB layout for BS 0.075" type – MIL standard layout 120
PCB layout for BS 0.075" type – Specific layout – Plugs 122
PCB layout for BS 0.075" type – Specific layout – Receptacles 124

CONNECTOR SAVERS

- One piece design - Metal or plastic shell 126
- One piece design - Low profile - Metal shell 127
- Back to back assembly - Metal or plastic shell 128
- Back to back assembly - Low profile - Metal shell 129

MICROSTRIP CONNECTORS

- Pigtail & solder cup assemblies 130
- PCB connector 132
- Microstrip general information 134
 - PCB layout for microstrip connector – 0.050" pitch* 137

HIGH DENSITY CONNECTORS 140

COMBO-D CONNECTORS

COMBO-D GENERAL INFORMATION

- Rectangular Combo Micro-D connectors. 142
- Contact arrangements 143
- Coaxial and power contacts and cables 144
- General characteristics 147

PCB COMBO CONNECTORS

- PCB connectors 148
- Board Straight type (BS) - 0.075" pitch 149
- Condensed Board Right angle (CBR) - 0.100" pitch 153

PIGTAIL COMBO CONNECTORS

- Male and female pigtail connectors 157

SPECIAL COMBO CONNECTORS 160

HERMETIC CONNECTORS

- Introduction to hermetic connectors 164
- Rear panel mounting guide 165
- Hermetic connectors 166

NON-MAGNETIC CONNECTORS

Non-magnetic Micro-D interconnect solutions 170

PIGTAIL CONNECTORS

- Non-magnetic metal shell connectors. 172
- Non-magnetic low profile metal shell connectors 173
- Non-magnetic plastic shell connectors 174

PCB CONNECTORS

- PCB connectors overview 175
- Non-magnetic PCB connectors 176

120 WAY CONNECTORS

- 120 way Micro-D connectors. 178
- 120 way connectors for cable and harnesses. 181
- Surface mount PCB card edge connectors 182
- BS connector 183
- Connector saver 183
- PCB layouts 184

ACCESSORIES

BACKSHELL

- Micro-D EMI-backshell 186
- AXOCLAMP® EMI band termination 189

HARDWARE

- Removable jackscrews 190
- Removable jackposts 192
- Rear panel mount jackposts for pigtails connectors. 193
- Removable jackposts for PCB connectors. 194
- Rear panel mount jackposts for PCB connectors. 196
- Non-removable hardware 198
- Float mount inserts 199
- U-clip mounting jackscrews 200

MICRO-D & NANO-D ASSEMBLY KIT 201

GENERAL INFORMATION

- Micro-D glossary of terms 22
- D-Line® connector mating guide 23
- Micro-D general characteristics 24
- Micro-D REACH & RoHS compliance 25
- Micro-D contact arrangements
 - Male rectangular connector 26
 - Female rectangular connector 27
- Micro-D weights 28
- Micro-D wire codes 29
- Micro-D colour codes 30
- Micro-D rear panel mounting guide 32
- Micro-D front panel mounting guide 33
- Micro-D panel cutouts 34



Micro-D connectors

GLOSSARY OF TERMS

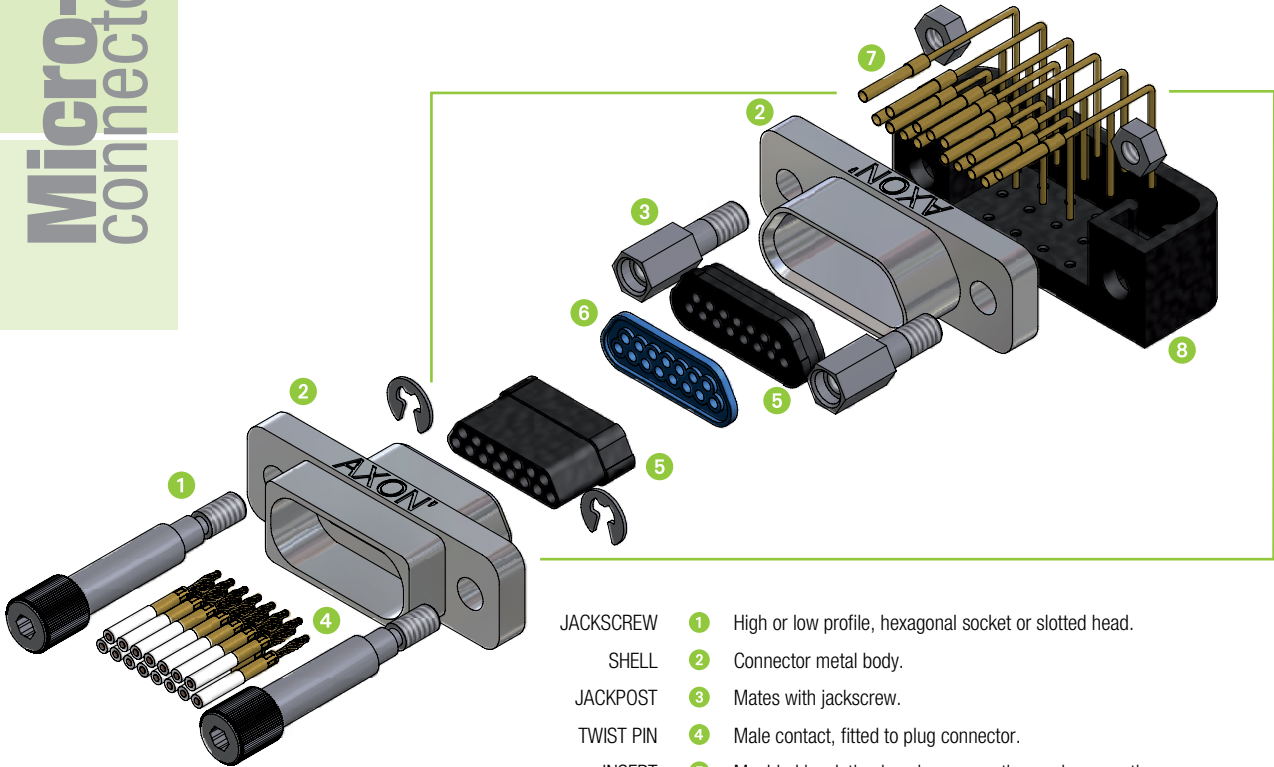

- JACKSCREW 1 High or low profile, hexagonal socket or slotted head.
- SHELL 2 Connector metal body.
- JACKPOST 3 Mates with jackscrew.
- TWIST PIN 4 Male contact, fitted to plug connector.
- INSERT 5 Moulded insulation housing, separating each connection.
- INTERFACIAL SEAL 6 Fitted to socket connector only.
- SOCKET 7 Female contact, fitted to socket connector (also known as socket).
- TRAY 8 Junction box used for PCB connectors only.

- Standard connector ● Manufactured to the standard dimensions and specifications.
- Special connector ● A standard connector modified to meet specific requirements.
- Custom made connector ● Designed to meet specific customer requirements.
- Connector saver ● Used to reduce wear and tear on equipment and systems while testing.
- BR connector ● Board Right Angle connector.
- CBR connector ● Condensed Board Right Angle connector.
- BS connector ● Board Straight connector.
- Strip connector ● Single row plastic connector with 1.27 mm spacing (.050").
- Pigtail connector ● Connector with insulated or uninsulated wires.
- Cord ● Cable harness with 2 connectors only.
- Jumper/ Extension cord ● Cord with 1 plug and 1 receptacle connector of the same number of ways.
- Harness ● Multi-branched cable assembly.
- LCP ● Liquid Crystal Polymer.
- Potting ● Epoxy compound used as an encapsulant.
- Solder cup connector ● Connector with solder type contacts, usually used for prototyping.

METAL CONNECTORS ARE SUPPLIED WITH ANTI-STATIC PROTECTIVE DUST CAPS

CONNECTOR MATING GUIDE

- ▶ **1-** Align both connectors and start to insert the male D-shape into the female one.

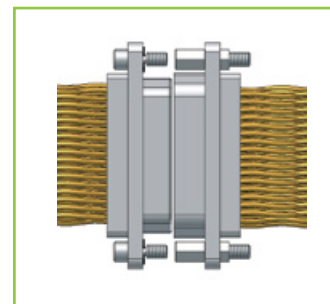

- ▶ **2-** Screw each jackscrew down alternately by no more than approximately one turn. This is essential to ensure correct mating.

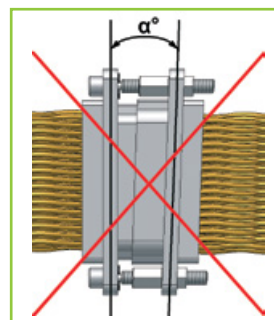
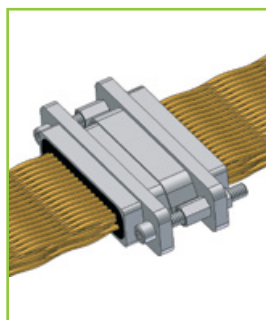
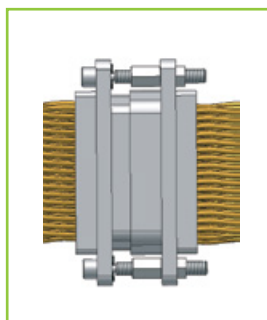

- ▶ **3-** Tighten both jackscrews to the recommended torque values set out below.

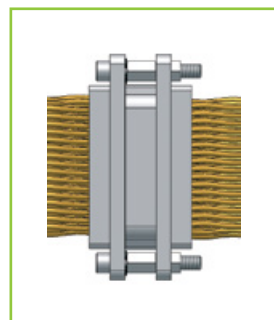

▶ **RECOMMENDED TORQUE VALUES**

- MICRO-D 9 to 69 way jackscrew: 0,28 N.m / 2.5 inch-pounds.
- MICRO-D 100 way jackscrew: 0,51 N.m / 4.5 inch-pounds.
- MICRO-D PCB mounting screws (inside threaded inserts):
 9 to 69 way with 2-56 UNC 2A screws: 0.14 N.m / 1.25 inch-pounds
 100 way with 4-40 UNC 2A screws: 0.34 N.m / 3 inch-pounds
- NANO-D 9 to 51 way jackscrew: 0,11 N.m / 1 inch-pounds.

Micro-D connectors

GENERAL CHARACTERISTICS

per MIL-DTL-83513*

AXON's range of Micro-D connectors which is covered by the MIL-DTL-83513* standard, is ideally suited to equipment and applications where weight, miniaturisation and long term performance are required. It is available:

- in 10 contact arrangements (9 to 100 contacts) for rectangular Micro-D connectors,
- and 2 to 40 contacts for microstrips.

► Electrical & mechanical characteristics

CHARACTERISTIC	SPECIFICATION	TEST METHOD
CURRENT RATING	3 A max.	EIA-364-70
CONTACT RESISTANCE	8 mΩ max.	EIA-364-06
INSULATION RESISTANCE	5000 MΩ min. @ 500 Vdc	EIA-364-21
DIELECTRIC WITHSTANDING VOLTAGE - SEA LEVEL 0 m - ALTITUDE 21 km (70,000 ft)	600 Vac 150 Vac	EIA-364-20
CONTACT ENGAGING AND SEPARATION FORCE	170 g max. (6 oz) 14 g min. (0.5 oz)	EIA-364-37
CONNECTOR MATING AND DE-MATING FORCE	283 g (10 oz) x number of contacts max.	EIA-364-13
CONTACT RETENTION	2.26 kg (5 lbs) for 5 seconds min.	EIA-364-29
DURABILITY	500 mating cycles min.	EIA-364-09
TEMPERATURE RANGES - STANDARD - HIGH TEMP	-55°C / +150°C -55°C / +200°C	
VIBRATION	20 g's - No discontinuity >1µs	EIA-364-28 - TEST CONDITION IV
SHOCK	50 g's - No discontinuity >1µs	EIA-364-27 - TEST CONDITION E
SALT SPRAY	48 hours	EIA-364-26 - TEST CONDITION B
HUMIDITY	Insulation resistance > 1MΩ	EIA-364-31 - METHOD IV

► Material & Finish

COMPONENT	MATERIAL	FINISH
MALE CONTACT (TWIST PIN)	COPPER AND BERYLLIUM COPPER	GOLD PLATING IN ACCORDANCE WITH ASTM-B488, TYPE II, CLASS 1 (1.27µM (0.00005") MIN), CODE C
FEMALE CONTACT	COPPER ALLOY	OVER NICKEL UNDERPLATE IN ACCORDANCE WITH SAE-AMS-QQ-N-290 CLASS 2 (1.27µM (0.00005") TO 3.81µM (0.00015"))
SOLDER CUP	BRASS	GOLD PLATING OVER NICKEL UNDERPLATING
METAL SHELL	ALUMINIUM ALLOY, TYPE 6061	YELLOW CHROMATE OVER CADMIUM IN ACCORDANCE WITH SAE-AMS-QQ-P-416, TYPE II, CLASS 3 ELECTROLESS NICKEL PLATING IN ACCORDANCE WITH SAE-AMS2404, CLASS 4, .0005 INCH MIN. BLACK ZINC NICKEL OVER NICKEL UNDERPLATE
	STAINLESS STEEL, 300 SERIES	PASSIVATION IN ACCORDANCE WITH SAE-AMS2700
PLASTIC SHELL / INSERT / PCB TRAY	LIQUID CRYSTAL POLYMER, 30% LOADED GLASS FIBRE POLYESTER, 94V0, IN ACCORDANCE WITH MIL-M-24519 (200°C)	
INTERFACIAL SEAL	FLUOROSILICONE RUBBER	
HARDWARE	STAINLESS STEEL, 300 SERIES	PASSIVATION IN ACCORDANCE WITH SAE-AMS2700
ENCAPSULANT	EPOXY RESIN	
INSULATED WIRE	PTFE INSULATED SILVER PLATED COPPER IN ACCORDANCE WITH NEMA-HP3 PTFE INSULATED SILVER PLATED COPPER IN ACCORDANCE WITH SAE-AS22759/11 ETFE INSULATED SILVER PLATED COPPER IN ACCORDANCE WITH SAE-AS22759/33	
UNINSULATED WIRE	GOLD PLATED SOLID COPPER WIRE IN ACCORDANCE WITH A-A-59551 TIN PLATED SOLID COPPER WIRE IN ACCORDANCE WITH A-A-59551	

*: ISSUE G AT TIME OF GOING TO PRESS

REACH & RoHS COMPLIANCE

▶ RoHS compliance

AXON' CABLE has been pro-actively implementing measures for many years to ensure compliance with the European Directive 2011/65/EU which came into force on 21st July 2011. The Directive prohibits the use of Hazardous Substances such as lead, mercury, hexavalent chromium, cadmium, bromine compounds (PBB and PBDE) and various phthalates. It relates to all components of products which are used in the manufacture of electrical and electronic equipment.

As a cable and connector manufacturer, AXON' has taken actions to ensure compliance with directive 2000/53/EC applicable since 21st October 2000.

COMPONENT SPECIFIC RoHS COMPLIANCE

COMPONENT	MATERIAL	FINISH	RoHS STATUS
PIN CONTACT (TWIST PIN)	COPPER + BERYLLIUM COPPER	GOLD	RoHS Compliant
SOCKET CONTACT	COPPER ALLOY	GOLD	RoHS Compliant
PLASTIC SHELL	LIQUID CRYSTAL POLYMER	N/A	RoHS Compliant
METAL SHELL	ALUMINIUM ALLOY TYPE 6061	YELLOW CHROMATE OVER CADMIUM	RoHS Compliant *
	* ELECTROLESS NICKEL & BLACK ZINC NICKEL ARE THE BEST RoHS ALTERNATIVES		
	ALUMINIUM ALLOY TYPE 6061	ELECTROLESS NICKEL	RoHS Compliant
	ALUMINIUM ALLOY TYPE 6061	BLACK ZINC NICKEL	RoHS Compliant
	STAINLESS STEEL 300 SERIES	PASSIVATION	RoHS Compliant
PLASTIC INSERT / PCB TRAY	LIQUID CRYSTAL POLYMER	N/A	RoHS Compliant
INTERFACIAL SEAL	FLUOROSILICONE RUBBER	N/A	RoHS Compliant
HARDWARE	STAINLESS STEEL 300 SERIES	PASSIVATION	RoHS Compliant
"STANDARD" SERIES PCB TERMINATION	SOLID COPPER WIRE	GOLD	RoHS Compliant
	SOLID COPPER WIRE	NOT LEADED TIN 97% MAX TIN	RoHS Compliant
MIL VERSION PCB TERMINATION	SOLID COPPER WIRE	LEADED TIN 97% MAX TIN	RoHS Compliant
ENCAPSULANT	EPOXY RESIN 150°C VERSION	N/A	RoHS Compliant
	EPOXY RESIN 200°C VERSION	N/A	RoHS Compliant

▶ Application of REACH

The new EU regulation on the Registration, Evaluation, Authorisation and restriction of Chemicals (REACH) came into force in June 2007. The regulation concerns the authorised use of chemicals. It requires manufacturers and importers to register substances and their use with the European Chemical Agency (ECHA).

AXON' CABLE is known as a "downstream user" with respect to the REACH regulation, and a manufacturer of "Articles". AXON' CABLE products are not intended to release any undesired substance under normal and reasonable operations of use.

To this day AXON' CABLE have not identified any component containing any SVHC in their product range.

Micro-D connectors

CONTACT ARRANGEMENTS

► Mating face of male rectangular connector

- 1.27 mm (.050") contact spacing.
- 1.09 mm (.043") spacing between rows.

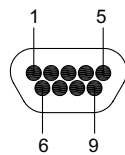

9 CONTACTS

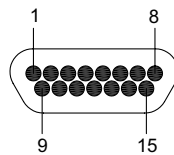

15 CONTACTS

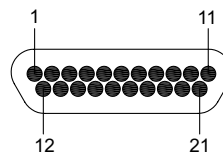

21 CONTACTS

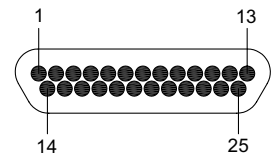

25 CONTACTS

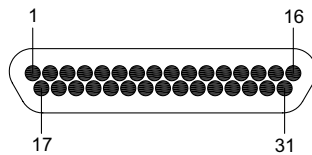

31 CONTACTS

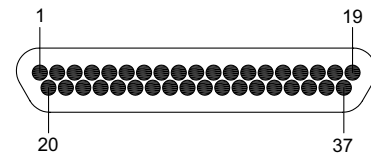

37 CONTACTS

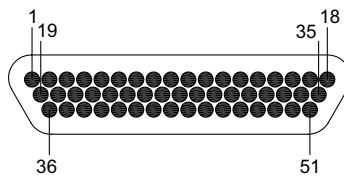

51 CONTACTS

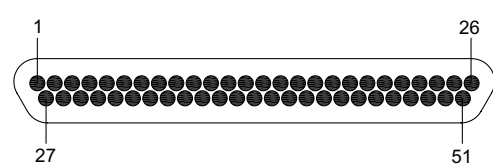

51 CONTACTS DOUBLE ROW (51DR)

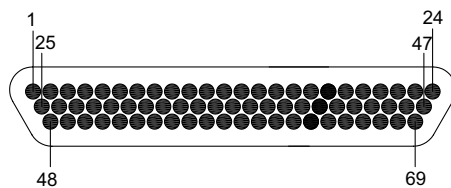

69 CONTACTS

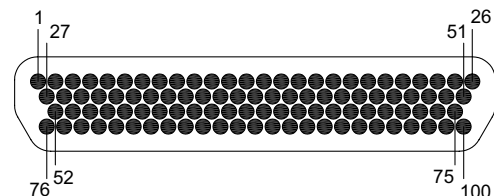

100 CONTACTS

120 CONTACTS: SEE PAGE 178 OR 302
OTHER CONTACT ARRANGEMENTS AVAILABLE ON REQUEST

CONTACT ARRANGEMENTS

► Mating face of female rectangular connector

- 1.27 mm (.050") contact spacing.
- 1.09 mm (.043") spacing between rows.

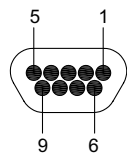

9 CONTACTS

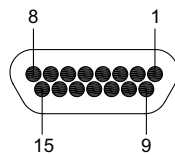

15 CONTACTS

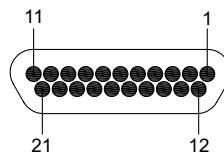

21 CONTACTS

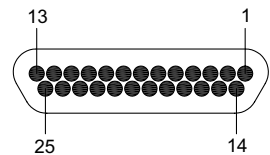

25 CONTACTS

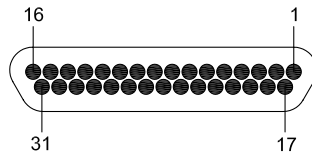

31 CONTACTS

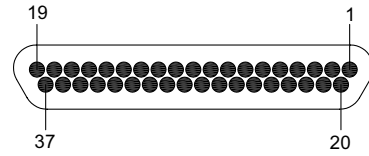

37 CONTACTS

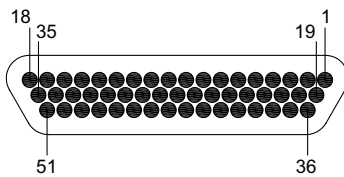

51 CONTACTS

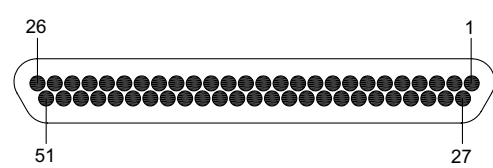

51 CONTACTS DOUBLE ROW (51DR)

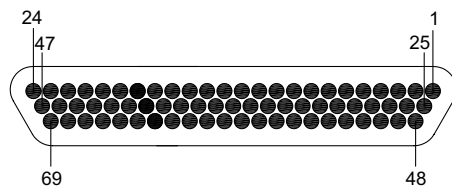

69 CONTACTS

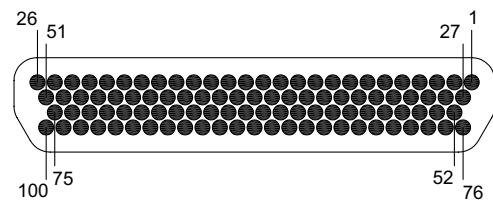

100 CONTACTS

120 CONTACTS: SEE PAGE 178 OR 302
OTHER CONTACT ARRANGEMENTS AVAILABLE ON REQUEST

Micro-D connectors

MICRO-D WEIGHTS

MICRO-D ALUMINIUM CONNECTOR WEIGHTS IN GRAMS ¹								
NB OF CONTACT	GENDER	SOLDER CUP ²	PIGTAIL ³	PCB CBR .100" pitch ⁴	PCB CBR .075" pitch ⁴	PCB BR .100" pitch ⁴	PCB BS .100" pitch ⁴	PCB BS .075" pitch ⁴
9	MALE	1.8	1.6	3.6	3.6	5.5	4.2	3.9
	FEMALE	1.8	1.6	3.6	3.5	5.5	4.2	3.9
15	MALE	2.4	2.1	4.4	4.4	6.7	4.8	4.7
	FEMALE	2.3	2.0	4.3	4.3	6.6	4.7	4.6
21	MALE	3.0	2.6	5.2	5.0	7.5	5.9	5.4
	FEMALE	2.9	2.5	5.1	4.9	7.4	5.8	5.3
25	MALE	3.4	2.9	5.6	5.5	7.9	6.3	5.8
	FEMALE	3.2	2.7	5.5	5.4	7.8	6.2	5.7
31	MALE	3.9	3.3	7.1	6.3	9.2	7.4	6.6
	FEMALE	3.8	3.2	6.9	6.1	9.0	7.2	6.4
37	MALE	4.6	3.9	8.1	7.2	10.7	8.6	7.4
	FEMALE	4.4	3.7	7.8	6.9	10.4	8.3	7.1
51DR	MALE	5.9	5.0	10.1	9.1	13.6	12.1	8.4
	FEMALE	5.7	4.7	10.0	8.9	13.4	12.0	8.3
51	MALE	5.3	4.6	10.4	9.0	13.6	9.4	8.1
	FEMALE	5.2	4.4	10.1	8.7	13.4	9.1	7.8
69	MALE	6.9	5.9	13.5	11.1	15.1	13.3	9.7
	FEMALE	6.4	5.5	13.0	10.6	14.6	12.8	9.2
100	MALE	9.5	7.2	25.0	19.7	26.8	24.0	18.4
	FEMALE	8.9	6.5	24.3	19.0	26.1	23.3	17.7

MICRO-D STAINLESS STEEL WEIGHT ADDERS IN GRAMS ¹			
NB OF CONTACT	GENDER	SOLDER CUP & PIGTAIL	PCB
9	MALE	2.2	1.8
	FEMALE	2.1	1.7
15	MALE	2.6	2.1
	FEMALE	2.5	2.0
21	MALE	3.0	2.4
	FEMALE	2.8	2.3
25	MALE	3.2	2.6
	FEMALE	3.0	2.5
31	MALE	3.6	3.0
	FEMALE	3.4	2.7
37	MALE	4.0	3.3
	FEMALE	3.8	3.0
51DR	MALE	4.9	4.0
	FEMALE	4.6	3.7
51	MALE	4.1	3.4
	FEMALE	3.7	3.0
69	MALE	4.7	3.8
	FEMALE	4.2	3.4
100	MALE	6.3	5.3
	FEMALE	5.7	4.7

NOTES

1 - NOMINAL WEIGHT SHOWN. ADD 10% FOR MAXIMUM WEIGHT.

2 - SOLDER CUPS: CONNECTOR WEIGHT DOES NOT INCLUDE THE HARDWARE WEIGHT.

3 - PIGTAILS: CONNECTOR WEIGHT DOES NOT INCLUDE HARDWARE AND WIRE WEIGHTS. SEE TABLE PAGE 29 FOR WIRE WEIGHT CALCULATION.

4 - PCB CONNECTORS: NOMINAL WEIGHT INCLUDES THE HARDWARE WEIGHT.

WIRE CODES

Nominal dimensions are used throughout this chapter.

► Solid uninsulated wires

WIRE CODE	WIRE DESIGNATION	WEIGHT g/m	CONDUCTOR					
			MATERIAL	AWG	CONSTRUCTION mm (inch)	Ø mm (inch)	AREA mm ² (sq in)	RESISTANCE Ω/100m (Ω/ 1000 ft)
G	GPC2501	1.45	GOLD PLATED COPPER	25	1x0.455 1x.018	0.455 .018	0.163 .000252	11 33.5
T	TPCL2401	1.81	TIN PLATED COPPER	24	1x0.510 1x.0201	0.510 .0201	0.205 .000317	9 27.4
T (FOR PCB)	GPC2501 RoHS SOLDER DIPPED TIN	1.81	GOLD PLATED COPPER AND TIN LEAD-FREE (97% TIN MAX.)	24	1x0.510 1x.0201	0.510 .0201	0.205 .000317	11 33.5

► Insulated wires

WIRE CODE	WIRE DESIGNATION	WEIGHT g/m	CONDUCTOR						INSULATION		TEMPERATURE RATING	VOLTAGE RATING
			MATERIAL	AWG	CONSTRUCTION mm (inch)	Ø mm (inch)	AREA mm ² (sq in)	RESISTANCE Ω/100m (Ω/ 1000 ft)	MATERIAL	Ø mm (inch)		
1	E 2607	2.70	SPC **	26	7x0.160 7x.0063	0.480 .0189	0.141 .000219	12.8 39.0	EXTRUDED PTFE	1.00 .039	-90°C/ +200°C	600 V _{AC}
3	M22759/11-26*	2.82	SPC **	26	19x0.102 19x.0040	0.504 .020	0.154 .000239	12.6 38.4	EXTRUDED PTFE	0.96 .038	-90°C/ +200°C	600 V _{AC}
4	E 2619	3.00	SPC **	26	19x0.102 19x.0040	0.504 .020	0.154 .000239	12 36.6	EXTRUDED PTFE	1.00 .039	-90°C/ +200°C	600 V _{AC}
6	E 2807	2.00	SPC **	28	7x0.127 7x.0050	0.381 .015	0.088 .000136	20.1 61.3	EXTRUDED PTFE	0.90 .035	-90°C/ +200°C	600 V _{AC}
8	E 3007	1.50	SPC **	30	7x0.102 7x.0040	0.304 .012	0.057 .000088	31 94.5	EXTRUDED PTFE	0.80 .031	-90°C/ +200°C	600 V _{AC}
A	E 2407	3.60	SPC **	24	7x0.203 7x.0080	0.609 .024	0.228 .000353	8 24.4	EXTRUDED PTFE	1.10 .043	-90°C/ +200°C	600 V _{AC}
C	E 2419	4.10	SPC **	24	19x0.127 19x.0050	0.634 .025	0.239 .000370	7.6 23.2	EXTRUDED PTFE	1.15 .045	-90°C/ +200°C	600 V _{AC}
E	M22759/33-26	2.08	HIGH STRENGTH SPCA ***	26	19x0.102 19x.0040	0.483 .019	0.154 .000239	14.7 44.8	CROSSLINKED EXTRUDED MODIFIED ETFE	0.81 .032	-90°C/ +200°C	600 V _{AC}
F	E 2607*	2.70	SPC **	26	7x0.160 7x.0063	0.480 .0189	0.141 .000219	12.8 39.0	EXTRUDED PTFE	1.00 .039	-90°C/ +200°C	600 V _{AC}

*: ONLY FOR COLOUR CODE V
 **: SILVER PLATED COPPER
 ***: SILVER PLATED COPPER ALLOY

OTHER WIRE TYPES AVAILABLE ON REQUEST

Micro-D connectors

COLOUR CODES

► Colour codes F and L

All the wires have the same colour.
Available with all wire types.

COLOUR CODE	COLOUR
F	YELLOW
L	WHITE

OTHER COLOURS AVAILABLE ON REQUEST.

► Colour code W

Also called 10 colour repeat. (10 colours repeated in sequence)
as per MIL-DTL-83513. Available with all wire types.

PIN NUMBER	MIL-STD-681 NUMBER	COLOUR
1	0	BLACK
2	1	BROWN
3	2	RED
4	3	ORANGE
5	4	YELLOW
6	5	GREEN
7	6	BLUE
8	7	VIOLET
9	8	GREY
10	9	WHITE
11	0	BLACK
12	1	BROWN
13	2	RED
14	3	ORANGE
15	4	YELLOW
16	5	GREEN
17	6	BLUE
18	7	VIOLET
19	8	GREY
20	9	WHITE
21	0	BLACK

► Colour code V

Only available with 2607 AWG wires (Micro-D wire code F) and 2619 AWG wires (Micro-D wire code 3).

Colours and coloured stripes as per MIL-STD-681 system (except the appropriate colour code is the contact number minus 1).

Only available for Micro-D connectors with 51 contacts or less.

CONTACT NUMBER	MIL-STD-681 NUMBER	BASE COLOUR	FIRST STRIPE	SECOND STRIPE
1	0	BLACK	-	-
2	1	BROWN	-	-
3	2	RED	-	-
4	3	ORANGE	-	-
5	4	YELLOW	-	-
6	5	GREEN	-	-
7	6	BLUE	-	-
8	7	VIOLET	-	-
9	8	GREY	-	-
10	9	WHITE	-	-
11	90	WHITE	BLACK	-
12	91	WHITE	BROWN	-
13	92	WHITE	RED	-
14	93	WHITE	ORANGE	-
15	94	WHITE	YELLOW	-
16	95	WHITE	GREEN	-
17	96	WHITE	BLUE	-
18	97	WHITE	VIOLET	-
19	98	WHITE	GREY	-
20	901	WHITE	BLACK	BROWN
21	902	WHITE	BLACK	RED
22	903	WHITE	BLACK	ORANGE
23	904	WHITE	BLACK	YELLOW
24	905	WHITE	BLACK	GREEN
25	906	WHITE	BLACK	BLUE
26	907	WHITE	BLACK	VIOLET
27	908	WHITE	BLACK	GREY
28	912	WHITE	BROWN	RED
29	913	WHITE	BROWN	ORANGE
30	914	WHITE	BROWN	YELLOW
31	915	WHITE	BROWN	GREEN
32	916	WHITE	BROWN	BLUE
33	917	WHITE	BROWN	VIOLET
34	918	WHITE	BROWN	GREY
35	923	WHITE	RED	ORANGE
36	924	WHITE	RED	YELLOW
37	925	WHITE	RED	GREEN
38	926	WHITE	RED	BLUE
39	927	WHITE	RED	VIOLET
40	928	WHITE	RED	GREY
41	934	WHITE	ORANGE	YELLOW
42	935	WHITE	ORANGE	GREEN
43	936	WHITE	ORANGE	BLUE
44	937	WHITE	ORANGE	VIOLET
45	938	WHITE	ORANGE	GREY
46	945	WHITE	YELLOW	GREEN
47	946	WHITE	YELLOW	BLUE
48	947	WHITE	YELLOW	VIOLET
49	948	WHITE	YELLOW	GREY
50	956	WHITE	GREEN	BLUE
51	957	WHITE	GREEN	VIOLET

Micro-D connectors

REAR PANEL MOUNTING GUIDE

- 2 sizes of hardware: one version for all shell sizes for 9 to 69 way and a separate version for the 100 way shell size.
- 1 kit consists of 2 posts, 2 washers and 2 nuts.
- Material: 300 series stainless steel passivated.

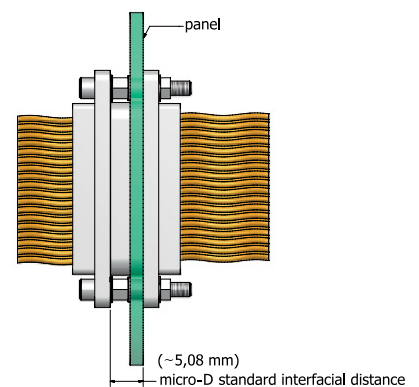
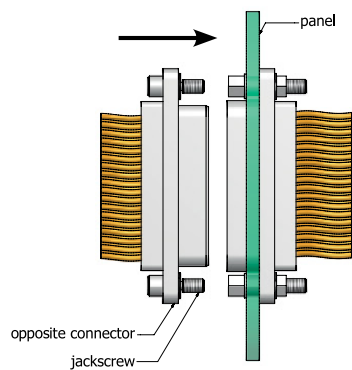
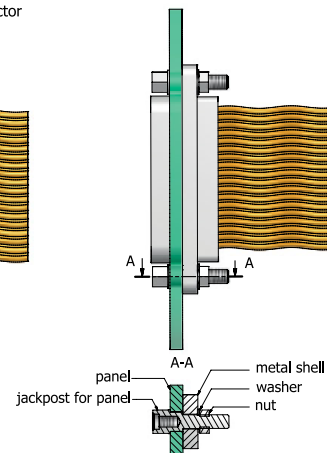
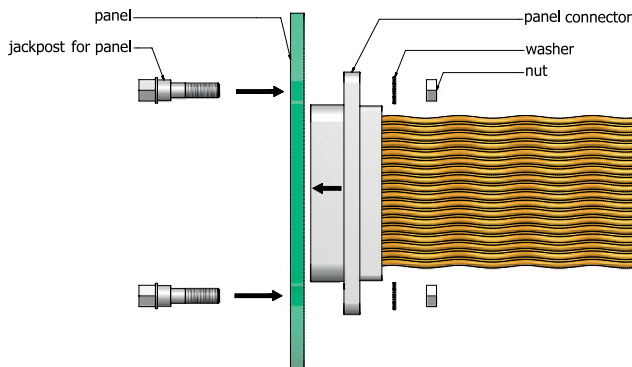
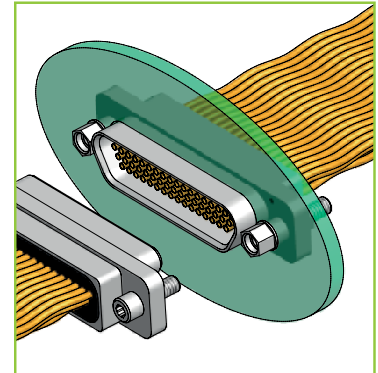

Dimensions are given in millimetres (inches).

HARDWARE CODE	Px	P1	P2	P3	P4	P5
PANEL THICKNESS -0.0 / +0.2 (-.000 / +.008)	mm	0.8	1.2	1.6	2	2.4
	inch	.031	.047	.062	.079	.094
KIT PART NUMBER	9-69 way	MDAHMP01	MDAHMP02	MDAHMP03	MDAHMP04	MDAHMP05
	100 way	MDAHMP11	MDAHMP12	MDAHMP13	MDAHMP14	MDAHMP15
DIM. A	mm	0.7	1.1	1.5	1.9	2.3
	inch	.028	.043	.059	.075	.091

FRONT PANEL MOUNTING GUIDE

- 2 sizes of hardware: one version for all shell sizes for 9 to 69 way and a separate version for the 100 way shell size.
- 1 kit consists of 2 posts, 2 washers and 2 nuts.
- Material: 300 series stainless steel passivated.

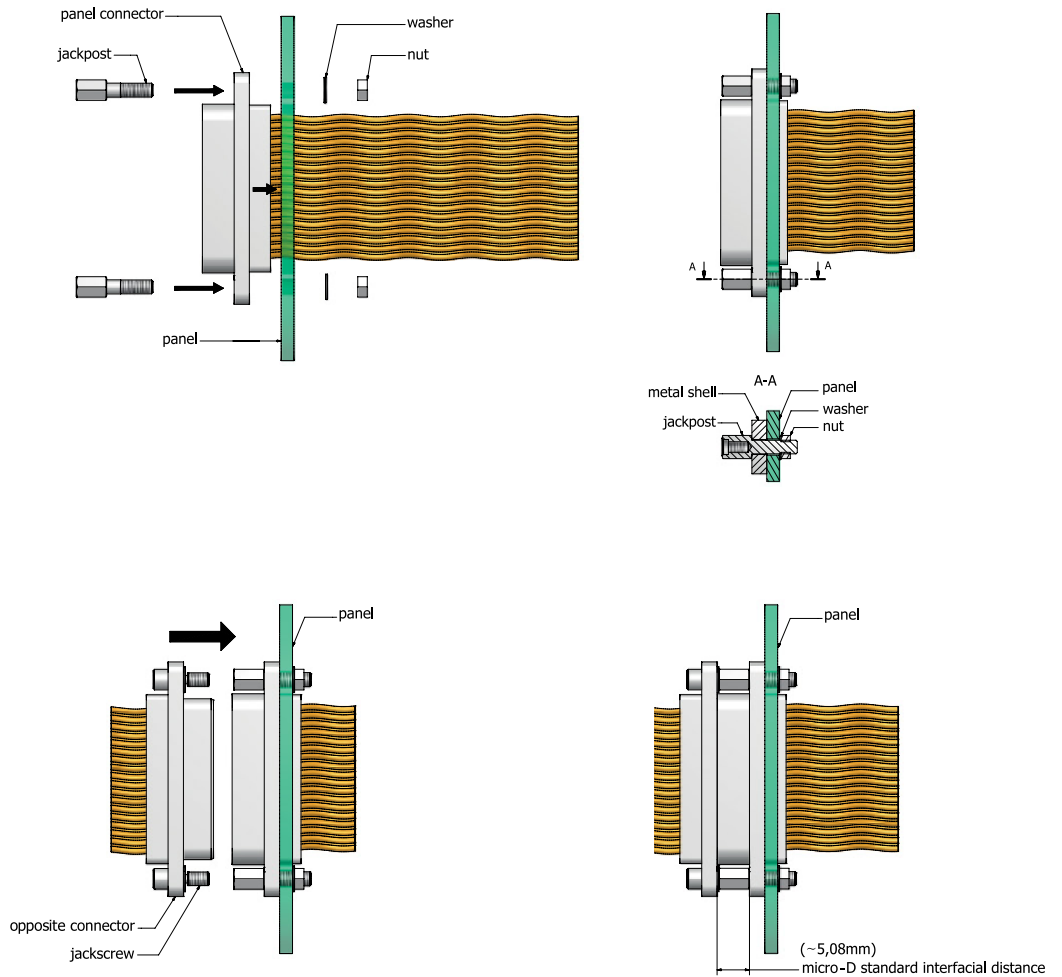
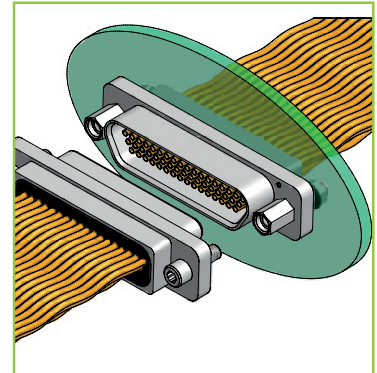

KIT PART NUMBER	9-69 way	MDAHM507
	100 way	MDAHM517

Micro-D connectors

PANEL CUTOUTS

► Metal shell & Plastic shell

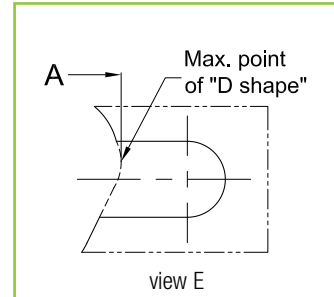

9 TO 69 CONTACTS

FIGURE 1 FRONT MOUNT

FIGURE 2 REAR MOUNT

Dimensions are in millimetres (inches).

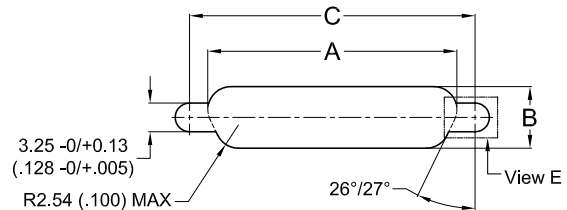
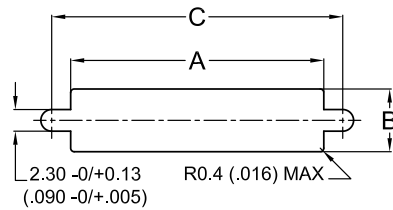

► Metal shell

100 CONTACTS

FIGURE 1 FRONT MOUNT

FIGURE 2 REAR MOUNT

Dimensions are in millimetres (inches).

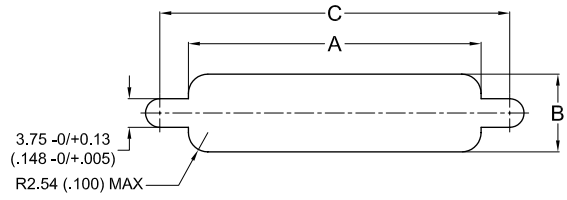
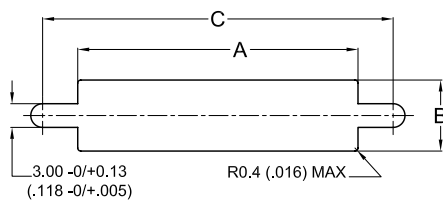

► Dimensions

Dimensions are in millimetres (inches)

LAYOUT	FIGURE N°	METAL SHELLS			PLASTIC SHELLS		
		A -0/ +0.1 (-0 /+.004)	B -0/ +0.1 (-0 /+.004)	C -0/ +0.13 (-0 /+.005)	A -0/ +0.1 (-0 /+.004)	B -0/ +0.1 (-0 /+.004)	C -0/ +0.13 (-0 /+.005)
9	1	10.26 (.404)	6.96 (.274)	14.48 (.570)	10.46 (.412)	4.50 (.177)	14.48 (.570)
	2	10.36 (.408)	6.55 (.258)	14.48 (.570)	9.78 (.385)	5.66 (.223)	14.48 (.570)
15	1	14.07 (.554)	6.96 (.274)	18.29 (.720)	14.27 (.562)	4.50 (.177)	18.29 (.720)
	2	14.20 (.559)	6.55 (.258)	18.29 (.720)	13.59 (.535)	5.66 (.223)	18.29 (.720)
21	1	17.88 (.704)	6.96 (.274)	22.10 (.870)	18.08 (.712)	4.50 (.177)	22.10 (.870)
	2	18.00 (.709)	6.55 (.258)	22.10 (.870)	17.40 (.685)	5.66 (.223)	22.10 (.870)
25	1	20.42 (.804)	6.96 (.274)	24.64 (.970)	20.62 (.812)	4.50 (.177)	24.64 (.970)
	2	20.55 (.809)	6.55 (.258)	24.64 (.970)	19.94 (.785)	5.66 (.223)	24.64 (.970)
31	1	24.23 (.954)	6.96 (.274)	28.45 (1.120)	24.43 (.962)	4.50 (.177)	28.45 (1.120)
	2	24.36 (.959)	6.55 (.258)	28.45 (1.120)	23.75 (.935)	5.66 (.223)	28.45 (1.120)
37	1	28.04 (1.104)	6.96 (.274)	32.26 (1.270)	28.24 (1.112)	4.50 (.177)	32.26 (1.270)
	2	28.17 (1.109)	6.55 (.258)	32.26 (1.270)	27.56 (1.085)	5.66 (.223)	32.26 (1.270)
51 DR	1	36.93 (1.454)	6.96 (.274)	41.15 (1.620)	-	-	-
	2	37.03 (1.458)	6.55 (.258)	41.15 (1.620)	-	-	-
51	1	26.77 (1.054)	8.00 (.315)	38.62 (1.520)	26.97 (1.062)	5.71 (.225)	31.00 (1.220)
	2	26.90 (1.059)	7.64 (.301)	38.62 (1.520)	26.29 (1.035)	6.73 (.264)	31.00 (1.220)
69	1	34.39 (1.354)	8.00 (.315)	31.00 (1.220)	-	-	-
	2	34.49 (1.358)	7.64 (.301)	31.00 (1.220)	-	-	-
100	1	36.73 (1.446)	9.25 (.364)	45.85 (1.805)	-	-	-
	2	37.06 (1.459)	10.31 (.406)	45.85 (1.805)	-	-	-

► Panel mounting dimensions

Dimensions are in millimetres (inches).

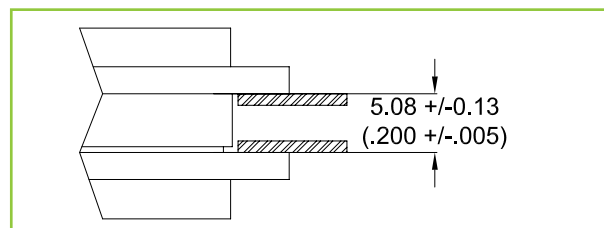

Rear mount of male and female connectors.

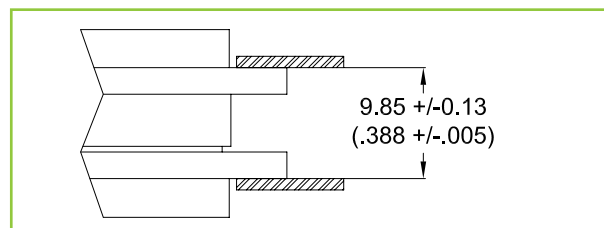

Front mount of male and female connectors.

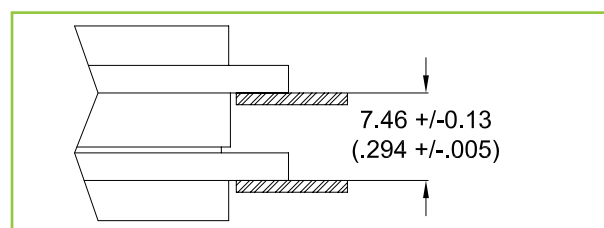

Front mount of male connector and rear mount of female connector, or vice versa.

MIL-DTL-83513 CONNECTORS



MIL-DTL-83513
CONNECTORS

Micro-D QPL - CAGE CODE: OKOJ2

M83513 /01 & /02

- Solder cup connector - Metal shell 38

M83513 /03 & /04

- Pigtail connector - Metal shell 40

M83513 /06 & /07

- Solder cup connector - Plastic shell 42

M83513 /08 & /09

- Pigtail connector - Plastic shell 44

M83513 /10 TO /15

- PCB connector - Narrow profile - Right angle
0.100" pitch - Metal shell 46
- PCB layout for QPL narrow profile 48

M83513 /16 TO /21

- PCB connector - Standard profile - Right angle
0.100" pitch - Metal shell 50
- PCB layout for QPL standard profile 52

M83513 /22 TO /27

- PCB connector - Straight - 0.100" pitch - Metal shell 54
- PCB layout for QPL Straight - 0.100" pitch. 56

M83513 /28 TO /33

- PCB connector - Straight - 0.075" pitch - Metal shell 58
- PCB layout for QPL Straight - 0.075" pitch. 60

MILITARY CROSS REFERENCE CHART 417



Rectangular
Micro-D connectors

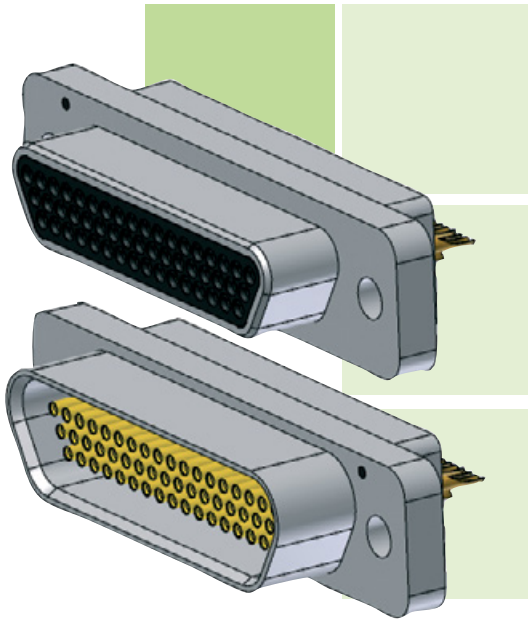

MIL-DTL-83513 /01 & /02

SOLDER CUP CONNECTOR

METAL SHELL

- Metal shell recommended for environmental and EMI applications.
- Ideal for prototyping or where pigtail type connectors cannot be used.

CAGE CODE: OK0J2

IDENTIFICATION CODE

M83513/

01-

G

N

SERIES

M83513/: QPL series.

TYPE

- 01-**: Pin connector, metal shell.
- 02-**: Socket connector, metal shell.

NUMBER OF CONTACTS

- A**: 9.
- B**: 15.
- C**: 21.
- D**: 25.
- E**: 31.
- F**: 37.
- G**: 51.
- H**: 100.

See pages 26 & 27 for contact arrangements.

SHELL FINISH

- C**: Cadmium plating.
- N**: Nickel plating.
- P**: Passivated stainless steel.

DIMENSIONS

Dimensions are in millimetres (inches).

MALE connector

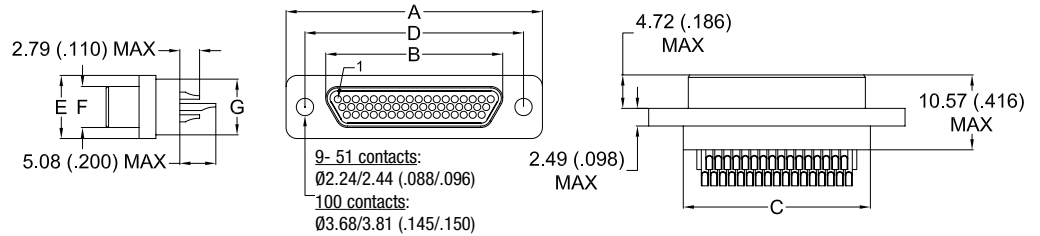

FEMALE connector

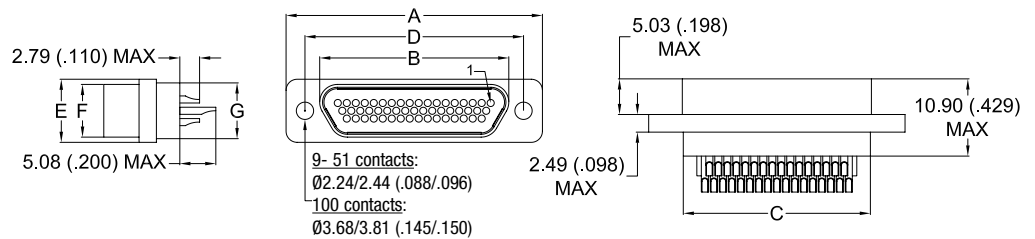

MIL-DTL-83513
CONNECTORS

Rectangular
Micro-D connectors

	A ± 0.25 (±.010)	B max.		C -0.46/+0.25 (-.018/+.010)	D ± 0.13 (±.005)	E ± 0.25 (±.010)	F max.		G max.
		Male	Female				Male	Female	
9 P / 9 S	19.69 .775	8.48 .334	10.16 .400	9.91 .390	14.35 .565	7.57 .298	4.69 .185	6.35 .250	6.86 .270
15 P / 15 S	23.50 .925	12.29 .484	14.00 .551	13.72 .540	18.16 .715	7.57 .298	4.69 .185	6.35 .250	6.86 .270
21 P / 21 S	27.31 1.075	16.10 .634	17.81 .701	17.53 .690	21.97 .865	7.57 .298	4.69 .185	6.35 .250	6.86 .270
25 P / 25 S	29.85 1.175	18.64 .734	20.35 .801	20.07 .790	24.51 .965	7.57 .298	4.69 .185	6.35 .250	6.86 .270
31 P / 31 S	33.66 1.325	22.45 .884	24.16 .951	23.88 .940	28.32 1.115	7.57 .298	4.69 .185	6.35 .250	6.86 .270
37 P / 37 S	37.47 1.475	26.26 1.034	27.96 1.101	27.69 1.090	32.13 1.265	7.57 .298	4.69 .185	6.35 .250	6.86 .270
51 P / 51 S	36.20 1.425	24.99 .984	26.70 1.051	26.42 1.040	30.86 1.215	8.66 .341	5.79 .228	7.44 .293	7.87 .310
100 P / 100 S	54.86 2.160	35.15 1.384	38.86 1.451	36.37 1.432	45.72 1.800	9.75 .384	6.88 .271	8.46 .333	9.14 .360

SUMMARY OF CHARACTERISTICS

ELECTRICAL & MECHANICAL PERFORMANCE	
CURRENT RATING	3 A max.
CONTACT RESISTANCE	8 mΩ max.
INSULATION RESISTANCE	5000 MΩ min. @ 500 Vdc
DIELECTRIC WITHSTANDING VOLTAGE	Sea Level: 600 V _{AC} Altitude 21 km (70,000 ft): 150 V _{AC}
CONTACT ENGAGING FORCE	170 g max. (6 oz)
CONTACT SEPARATING FORCE	14 g min. (0.5 oz)
CONTACT RETENTION	2.26 kg (5 lbs)
DURABILITY	500 mating cycles min.
VIBRATION	20g's – No discontinuity > 1 μs
SHOCK	50g's – No discontinuity > 1 μs

MATERIAL & FINISH	
SHELL	Aluminium alloy 6061 or 300 series stainless steel, see ordering info for plating options
MOULDED INSULATOR	Liquid Crystal Polymer (LCP)
INTERFACIAL SEAL	Fluorosilicone rubber
PIN CONTACT	Copper and beryllium copper, gold over nickel plating
SOCKET CONTACT	Copper alloy, gold over nickel plating
SOLDER CUP	Copper alloy, gold over nickel plating
ENCAPSULANT	Epoxy resin

SEE PAGE 24 FOR MORE INFORMATION

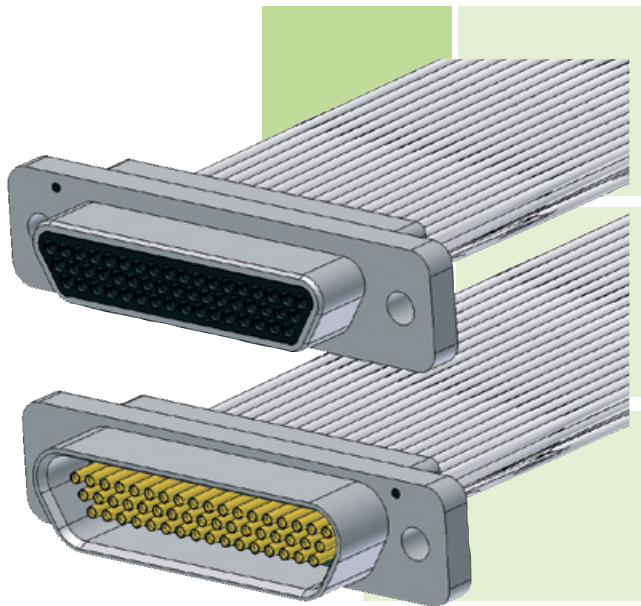

MIL-DTL-83513 /03 & /04

PIGTAIL CONNECTOR

METAL SHELL

- Metal shell recommended for environmental and EMI applications.
- Supplied pre-wired and fully potted.

CAGE CODE: OK0J2

M83513/

03-

G

01

N

IDENTIFICATION CODE

SERIES

M83513/: QPL series.

TYPE

- 03-**: Pin connector, metal shell.
- 04-**: Socket connector, metal shell.

NUMBER OF CONTACTS

- A**: 9.
- B**: 15.
- C**: 21.
- D**: 25.
- E**: 31.
- F**: 37.
- G**: 51.
- H**: 100.

See pages 26 & 27 for contact arrangements.

WIRE TYPE

M22759/11-26 ■

PTFE Insulated.

01: 46 cm (18") white.

02: 92 cm (36") white.

03: 46 cm (18")

10 colour repeat.

04: 92 cm (36")

10 colour repeat.

13: 183 cm (72") white.

14: 183 cm (72")

10 colour repeat.

See page 30 for colour codes & page 29 for wire types.

M22759/33-26 ■

Irradiated ETFE insulated.

09: 46 cm (18") white.

10: 92 cm (36") white.

11: 46 cm (18")

10 colour repeat.

12: 92 cm (36")

10 colour repeat.

15: 183 cm (72") white.

16: 183 cm (72")

10 colour repeat.

SOLID UNINSULATED ■

05: 13 mm (0.5") gold plated.

06: 26 mm (1") gold plated.

07: 13 mm (0.5") tin plated.

08: 26 mm (1") tin plated.

SHELL FINISH

C: Cadmium plating.

N: Nickel plating.

P: Passivated stainless steel.

METAL CONNECTORS ARE SUPPLIED WITH ANTI-STATIC PROTECTIVE DUST CAPS

DIMENSIONS

Dimensions are in millimetres (inches).

MALE connector

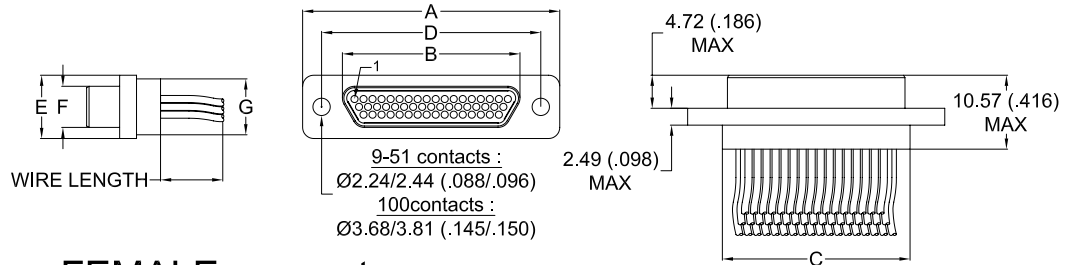

FEMALE connector

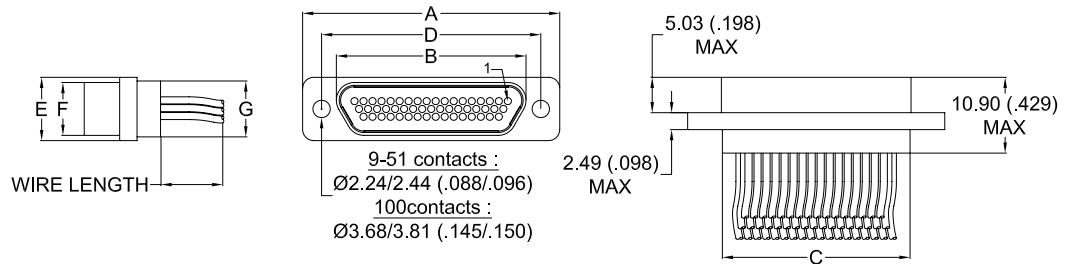

MIL-DTL-83513
CONNECTORS

Rectangular
Micro-D connectors

	A ± 0.25 (± 0.10)	B max.		C -0.46/+0.25 (-.018/+0.010)	D ± 0.13 (± 0.005)	E ± 0.25 (± 0.10)	F max.		G max.
		Male	Female				Male	Female	
9 P / 9 S	19.69 .775	8.48 .334	10.16 .400	9.91 .390	14.35 .565	7.57 .298	4.69 .185	6.35 .250	6.86 .270
15 P / 15 S	23.50 .925	12.29 .484	14.00 .551	13.72 .540	18.16 .715	7.57 .298	4.69 .185	6.35 .250	6.86 .270
21 P / 21 S	27.31 1.075	16.10 .634	17.81 .701	17.53 .690	21.97 .865	7.57 .298	4.69 .185	6.35 .250	6.86 .270
25 P / 25 S	29.85 1.175	18.64 .734	20.35 .801	20.07 .790	24.51 .965	7.57 .298	4.69 .185	6.35 .250	6.86 .270
31 P / 31 S	33.66 1.325	22.45 .884	24.16 .951	23.88 .940	28.32 1.115	7.57 .298	4.69 .185	6.35 .250	6.86 .270
37 P / 37 S	37.47 1.475	26.26 1.034	27.96 1.101	27.69 1.090	32.13 1.265	7.57 .298	4.69 .185	6.35 .250	6.86 .270
51 P / 51 S	36.20 1.425	24.99 .984	26.70 1.051	26.42 1.040	30.86 1.215	8.66 .341	5.79 .228	7.44 .293	7.87 .310
100 P / 100 S	54.86 2.160	35.15 1.384	36.86 1.451	36.37 1.432	45.72 1.800	9.75 .384	6.88 .271	8.46 .333	9.14 .360

SUMMARY OF CHARACTERISTICS

ELECTRICAL & MECHANICAL PERFORMANCE	
CURRENT RATING	3 A max.
CONTACT RESISTANCE	8 m Ω max.
INSULATION RESISTANCE	5000 M Ω min. @ 500 V _{dc}
DIELECTRIC WITHSTANDING VOLTAGE	Sea level: 600 V _{ac} Altitude 21 km (70,000 ft): 150 V _{ac}
CONTACT ENGAGING FORCE	170 g max. (6 oz)
CONTACT SEPARATING FORCE	14 g min. (0.5 oz)
CONTACT RETENTION	2.26 kg (5 lbs)
DURABILITY	500 Mating cycles min.
VIBRATION	20g's - No discontinuity > 1 μ s
SHOCK	50g's - No discontinuity > 1 μ s

MATERIAL & FINISH	
SHELL	Aluminium alloy 6061 or 300 Series stainless steel, see ordering info for plating options
MOULDED INSULATOR	Liquid Crystal Polymer (LCP)
INTERFACIAL SEAL	Fluorosilicone rubber
PIN CONTACT	Copper and beryllium copper, gold over nickel plating
SOCKET CONTACT	Copper alloy, gold over nickel plating
ENCAPSULANT	Epoxy resin

SEE PAGE 24 FOR MORE INFORMATION

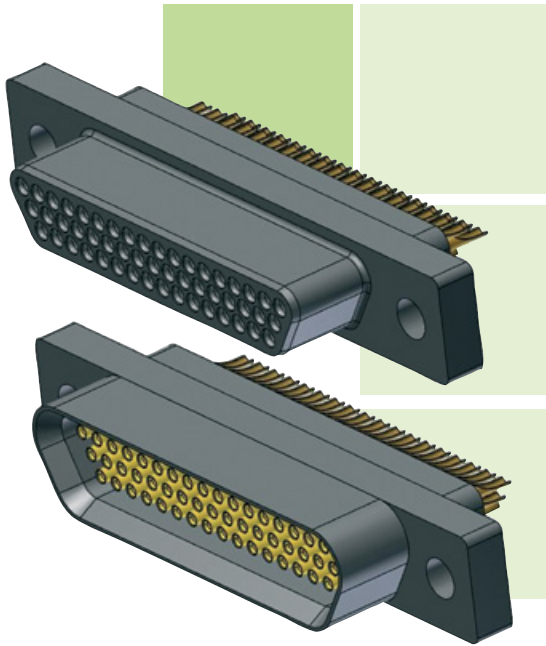

MIL-DTL-83513 /06 & /07

SOLDER CUP CONNECTOR

PLASTIC SHELL

- Ideal for prototyping
or where pigtail type connectors
cannot be used.

CAGE CODE: OK0J2

M83513/

06-

G

IDENTIFICATION CODE

SERIES

M83513/: QPL series.

TYPE

06-: Pin connector, plastic shell.

07-: Socket connector, plastic shell.

NUMBER OF CONTACTS

- A:** 9.
- B:** 15.
- C:** 21.
- D:** 25.
- E:** 31.
- F:** 37.
- G:** 51.

See pages 26 & 27 for contact arrangements.

DIMENSIONS

Dimensions are in millimetres (inches).

MALE connector

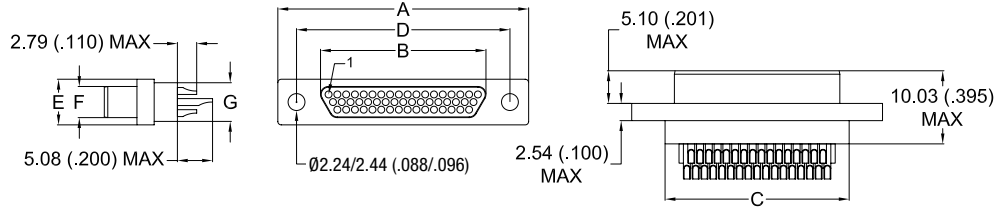

FEMALE connector

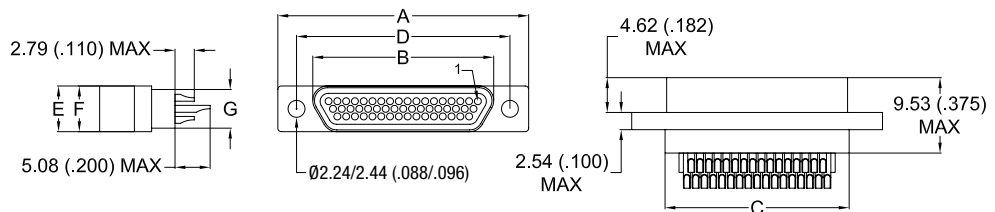

MIL-DTL-83513
CONNECTORS

Rectangular
Micro-D connectors

	A ± 0.25 (±.010)	B max.		C -0.46/+0.25 (-.018/+.010)	D ± 0.13 (±.005)	E max.	F max.		G max.
		Male	Female				Male	Female	
9 P / 9 S	19.76 .778	7.41 .292	9.65 .380	10.11 .398	14.35 .565	5.53 .218	3.40 .134	5.53 .218	4.39 .173
15 P / 15 S	23.57 .928	11.22 .442	13.46 .530	13.92 .548	18.16 .715	5.53 .218	3.40 .134	5.53 .218	4.39 .173
21 P / 21 S	27.38 1.078	15.03 .592	17.27 .680	17.73 .698	21.97 .865	5.53 .218	3.40 .134	5.53 .218	4.39 .173
25 P / 25 S	29.92 1.178	17.57 .692	19.81 .780	20.27 .798	24.51 .965	5.53 .218	3.40 .134	5.53 .218	4.39 .173
31 P / 31 S	33.73 1.328	21.38 .842	23.62 .930	24.08 .948	28.32 1.115	5.53 .218	3.40 .134	5.53 .218	4.39 .173
37 P / 37 S	37.54 1.478	25.19 .992	27.43 1.080	27.89 1.098	32.13 1.265	5.53 .218	3.40 .134	5.53 .218	4.39 .173
51 P / 51 S	36.27 1.428	23.92 .942	26.16 1.030	26.62 1.048	30.86 1.215	6.60 .260	4.50 .177	6.60 .260	5.59 .220

SUMMARY OF CHARACTERISTICS

ELECTRICAL & MECHANICAL PERFORMANCE	
CURRENT RATING	3 A max.
CONTACT RESISTANCE	8 mΩ max.
INSULATION RESISTANCE	5000 MΩ min. @ 500 V _{dc}
DIELECTRIC WITHSTANDING VOLTAGE	Sea level: 600 V _{ac} Altitude 21 km (70,000 ft): 150 V _{ac}
CONTACT ENGAGING FORCE	170 g max. (6 oz)
CONTACT SEPARATING FORCE	14 g min. (0.5 oz)
CONTACT RETENTION	2.26 Kg (5 lbs)
DURABILITY	500 mating cycles min.
VIBRATION	20g's – No discontinuity > 1 μs
SHOCK	50g's – No discontinuity > 1 μs

MATERIAL & FINISH	
MOULDED SHELL	Liquid Crystal Polymer (LCP)
PIN CONTACT	Copper and beryllium copper, gold over nickel plating
SOCKET CONTACT	Copper alloy, gold over nickel plating
SOLDER CUP	Copper alloy, gold over nickel plating
ENCAPSULANT	Epoxy resin

SEE PAGE 24 FOR MORE INFORMATION

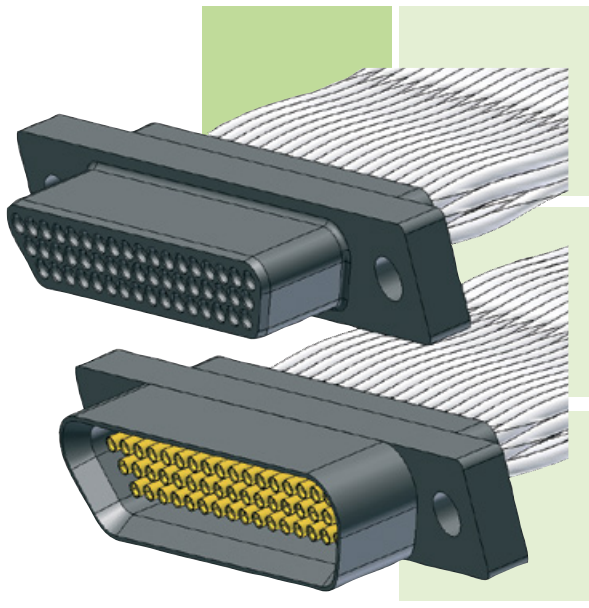

MIL-DTL-83513 /08 & /09

PIGTAIL CONNECTOR

PLASTIC SHELL

- Supplied pre-wired and fully potted.

CAGE CODE: OK0J2

IDENTIFICATION CODE

M83513/	08-	G	01
----------------	------------	----------	-----------

SERIES

M83513/: QPL series.

TYPE

08-: Pin connector, plastic shell.
09-: Socket connector, plastic shell.

NUMBER OF CONTACTS

- A**: 9.
- B**: 15.
- C**: 21.
- D**: 25.
- E**: 31.
- F**: 37.
- G**: 51.

See pages 26 & 27 for contact arrangements.

WIRE TYPE

- | | |
|---|--|
| <p>M22759/11-26 ■
PTFE Insulated.</p> <p>01: 46 cm (18") white.
 02: 92 cm (36") white.
 03: 46 cm (18")
10 colour repeat.
 04: 92 cm (36")
10 colour repeat.</p> <p>13: 183 cm (72") white.
 14: 183 cm (72")
10 colour repeat.</p> | <p>M22759/33-26 ■
Irradiated ETFE insulated.</p> <p>09: 46 cm (18") white.
 10: 92 cm (36") white.
 11: 46 cm (18")
10 colour repeat.
 12: 92 cm (36")
10 colour repeat.</p> <p>15: 183 cm (72") white.
 16: 183 cm (72")
10 colour repeat.</p> |
|---|--|
- See page 30 for colour codes & page 29 for wire type.

SOLID UNINSULATED ■

- 05**: 13 mm (0.5") gold plated.
- 06**: 26 mm (1") gold plated.
- 07**: 13 mm (0.5") tin plated.
- 08**: 26 mm (1") tin plated.

DIMENSIONS

Dimensions are in millimetres (inches).

MALE connector

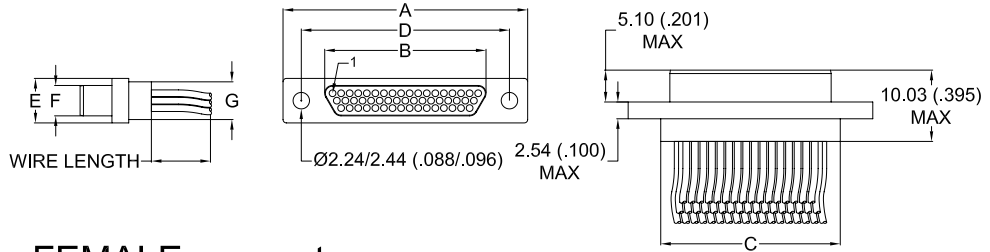

FEMALE connector

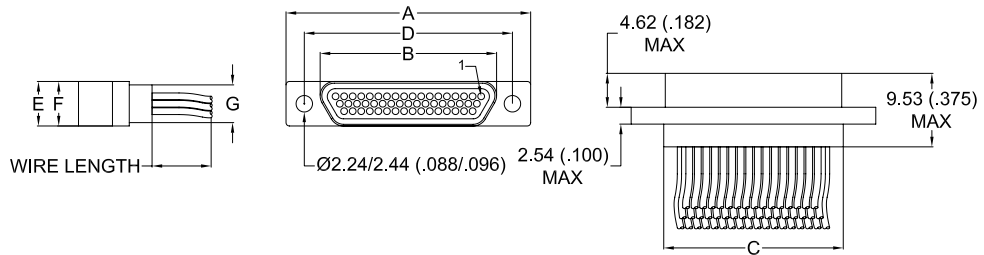

MIL-DTL-83513
CONNECTORS

Rectangular
Micro-D connectors

	A ± 0.25 (±.010)	B max.		C -0.46/+0.25 (-.018/+.010)	D ± 0.13 (±.005)	E max.	F max.		G max.
		Male	Female				Male	Female	
9 P / 9 S	19.76 .778	7.41 .292	9.65 .380	10.11 .398	14.35 .565	5.53 .218	3.40 .134	5.53 .218	4.39 .173
15 P / 15 S	23.57 .928	11.22 .442	13.46 .530	13.92 .548	18.16 .715	5.53 .218	3.40 .134	5.53 .218	4.39 .173
21 P / 21 S	27.38 1.078	15.03 .592	17.27 .680	17.73 .698	21.97 .865	5.53 .218	3.40 .134	5.53 .218	4.39 .173
25 P / 25 S	29.92 1.178	17.57 .692	19.81 .780	20.27 .798	24.51 .965	5.53 .218	3.40 .134	5.53 .218	4.39 .173
31 P / 31 S	33.73 1.328	21.38 .842	23.62 .930	24.08 .948	28.32 1.115	5.53 .218	3.40 .134	5.53 .218	4.39 .173
37 P / 37 S	37.54 1.478	25.19 .992	27.43 1.080	27.89 1.098	32.13 1.265	5.53 .218	3.40 .134	5.53 .218	4.39 .173
51 P / 51 S	36.27 1.428	23.92 .942	26.16 1.030	26.62 1.048	30.86 1.215	6.60 .260	4.50 .177	6.60 .260	5.59 .220

SUMMARY OF CHARACTERISTICS

ELECTRICAL & MECHANICAL PERFORMANCE	
CURRENT RATING	3 A max.
CONTACT RESISTANCE	8 mΩ max.
INSULATION RESISTANCE	5000 MΩ min. @ 500 V _{dc}
DIELECTRIC WITHSTANDING VOLTAGE	Sea level: 600 V _{ac} Altitude 21 km (70,000 ft): 150 V _{ac}
CONTACT ENGAGING FORCE	170 g max. (6 oz)
CONTACT SEPARATING FORCE	14 g min. (0.5 oz)
CONTACT RETENTION	2.26 kg (5 pounds)
DURABILITY	500 mating cycles min.
VIBRATION	20g's – No discontinuity > 1 μs
SHOCK	50g's – No discontinuity > 1 μs

MATERIAL & FINISH	
MOULDED SHELL	Liquid Crystal Polymer (LCP)
PIN CONTACT	Copper and beryllium copper, gold over nickel plating
SOCKET CONTACT	Copper alloy, gold over nickel plating
ENCAPSULANT	Epoxy resin

SEE PAGE 24 FOR MORE INFORMATION

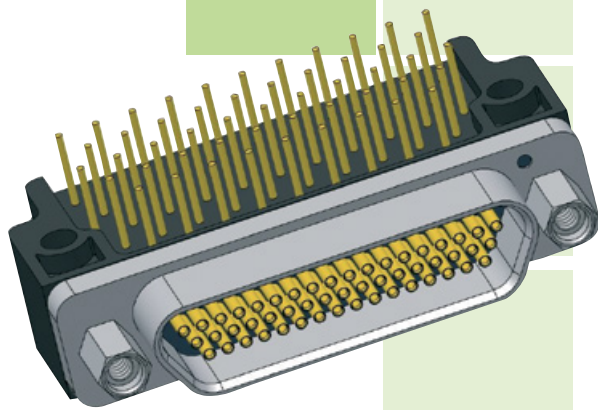

MIL-DTL-83513 /10 T0 /15

PCB CONNECTOR

NARROW PROFILE RIGHT ANGLE 0.100" PITCH

METAL SHELL

- Only available in metal shell version.
- Environmentally sealed.
- Most frequently used connector for flexible and rigid printed circuit boards.
- Several tail lengths available.

CAGE CODE: OK0J2

IDENTIFICATION CODE

M83513/

14-G

03

N

P

SERIES

M83513/: QPL series.

TYPE

- 10-A**: Pin connector, metal shell, 9 contacts.
- 10-B**: Pin connector, metal shell, 15 contacts.
- 10-C**: Pin connector, metal shell, 21 contacts.
- 10-D**: Pin connector, metal shell, 25 contacts.
- 10-E**: Pin connector, metal shell, 31 contacts.
- 10-F**: Pin connector, metal shell, 37 contacts.
- 11-G**: Pin connector, metal shell, 51 contacts.
- 12-H**: Pin connector, metal shell, 100 contacts.
- 13-A**: Socket connector, metal shell, 9 contacts.
- 13-B**: Socket connector, metal shell, 15 contacts.
- 13-C**: Socket connector, metal shell, 21 contacts.
- 13-D**: Socket connector, metal shell, 25 contacts.
- 13-E**: Socket connector, metal shell, 31 contacts.
- 13-F**: Socket connector, metal shell, 37 contacts.
- 14-G**: Socket connector, metal shell, 51 contacts.
- 15-H**: Socket connector, metal shell, 100 contacts.

See pages 26 & 27 for contact arrangements.

TERMINATION LENGTH

01: 2.80 mm (.109").

02: 3.56 mm (.140").

03: 4.37 mm (.172").

Tolerance ± 0.13 mm (.005").

SHELL FINISH

C: Cadmium plating.

N: Nickel plating.

P: Passivated stainless steel.

HARDWARE CODE

N: No jackpost or threaded insert.

P: Jackpost installed.

T: Threaded inserts installed for 10-A to 11-G and 13-A to 14-G only.

W: Jackpost and threaded inserts installed for 10-A to 11-G and 13-A to 14-G only.

U: Threaded inserts installed. For 12-H and 15-H only.

Y: Jackpost and threaded installed. For 12-H and 15-H only.

METAL CONNECTORS ARE SUPPLIED WITH ANTI-STATIC PROTECTIVE DUST CAPS

DIMENSIONS

Dimensions are in millimetres (inches).

FEMALE connector

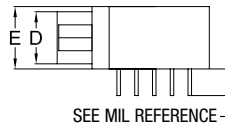
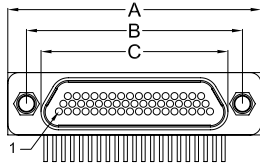

9-25 way connectors

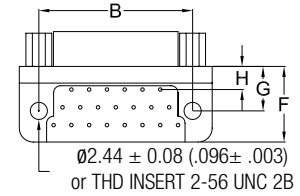

31-51 way connectors

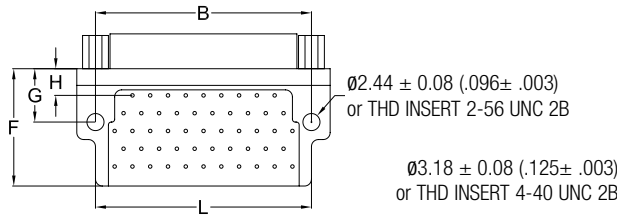

SEE CONTACT LAYOUT ON PCB PAGES 48 & 49

100 way connectors

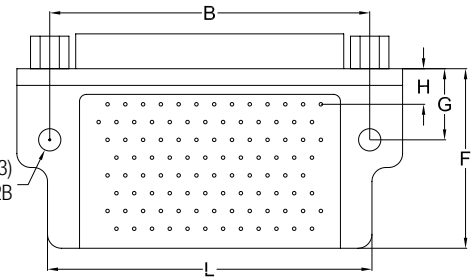

MIL-DTL-83513
CONNECTORS

Rectangular
Micro-D connectors

	A max.	B ± 0.13 ($\pm .005$)	C max.		D max.		E max.	F max.	G ± 0.25 ($\pm .010$)	H ± 0.25 ($\pm .010$)	L max.
			Male	Female	Male	Female					
9 P / 9 S	19.94 .785	14.35 .565	8.48 .334	10.16 .400	4.69 .185	6.35 .250	7.87 .310	10.80 .425	6.35 .250	5.84 .230	-
15 P / 15 S	23.75 .935	18.16 .715	12.29 .484	14.00 .551	4.69 .185	6.35 .250	7.87 .310	10.80 .425	6.35 .250	3.30 .130	-
21 P / 21 S	27.56 1.085	21.97 .865	16.10 .634	17.81 .701	4.69 .185	6.35 .250	7.87 .310	10.80 .425	6.35 .250	3.30 .130	-
25 P / 25 S	30.10 1.185	24.51 .965	18.64 .734	20.35 .801	4.69 .185	6.35 .250	7.87 .310	10.80 .425	6.35 .250	3.30 .130	-
31 P / 31 S	33.91 1.335	28.32 1.115	22.45 .884	24.16 .951	4.69 .185	6.35 .250	7.87 .310	13.34 .525	6.35 .250	3.30 .130	27.69 1.090
37 P / 37 S	37.72 1.485	32.13 1.265	26.26 1.034	27.96 1.101	4.69 .185	6.35 .250	7.87 .310	13.34 .525	6.35 .250	3.30 .130	30.23 1.190
51 P / 51 S	36.45 1.435	30.86 1.215	24.99 .984	26.70 1.051	5.79 .228	7.44 .293	8.76 .345	16.76 .660	7.62 .300	3.81 .150	31.24 1.230
100 P / 100 S	55.11 2.170	45.72 1.800	35.15 1.384	36.86 1.451	6.88 .271	8.46 .333	10.29 .405	25.65 1.010	10.16 .400	5.08 .200	46.36 1.825

SUMMARY OF CHARACTERISTICS

ELECTRICAL & MECHANICAL PERFORMANCE	
CURRENT RATING	3 A max.
CONTACT RESISTANCE	8 m Ω max.
INSULATION RESISTANCE	5000 M Ω min. @ 500 V _{dc}
DIELECTRIC WITHSTANDING VOLTAGE	Sea level: 600 V _{ac}
	Altitude 21 km (70,000 ft): 150 V _{ac}
CONTACT ENGAGING FORCE	170 g max. (6 oz)
CONTACT SEPARATING FORCE	14 g min. (0.5 oz)
CONTACT RETENTION	2.26 kg (5 lbs)
DURABILITY	500 mating cycles min.
VIBRATION	20g's - No discontinuity > 1 μ s
SHOCK	50g's - No discontinuity > 1 μ s

MATERIAL & FINISH	
SHELL	Aluminium Alloy 6061 or 300 series stainless steel, see ordering info for plating options
MOULDED INSULATOR	Liquid Crystal Polymer (LCP)
INTERFACIAL SEAL	Fluorosilicone rubber
PIN CONTACT	Copper and beryllium copper, gold over nickel plating
SOCKET CONTACT	Copper alloy, gold over nickel plating
ENCAPSULANT	Epoxy resin
MOULDED TRAY	Liquid Crystal Polymer (LCP)
PCB TERMINALS	AWG24 gold plated copper, solder dipped in 63/37 tin-lead
HARDWARE	300 series stainless steel, passivated

SEE PAGE 24 FOR MORE INFORMATION

PCB LAYOUT FOR NARROW PROFILE, RIGHT ANGLE 0.100" PITCH - MALE CONNECTORS

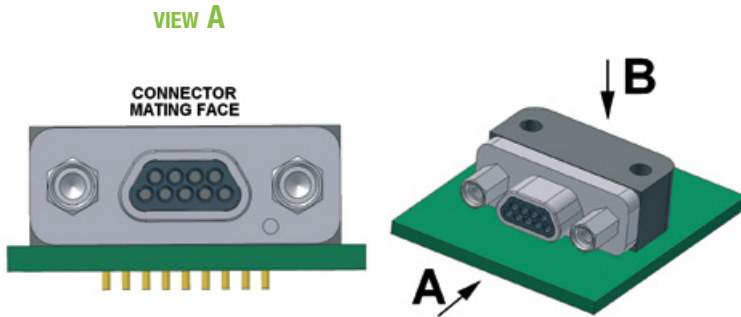

9 CONTACTS - VIEW B

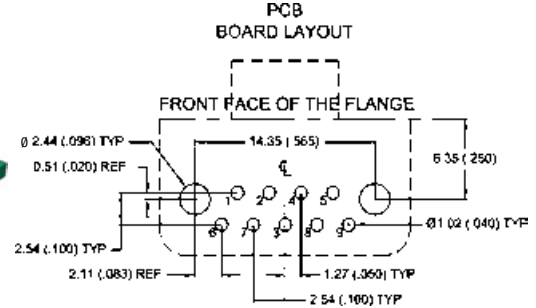

15 CONTACTS - VIEW B

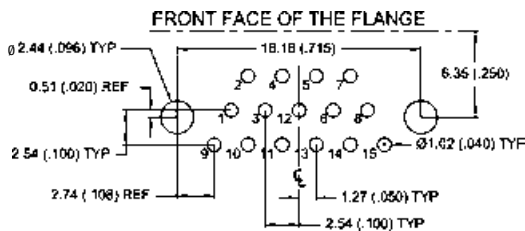

21 CONTACTS - VIEW B

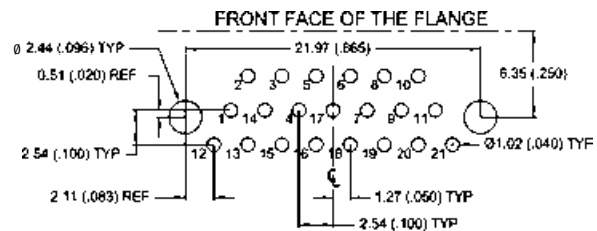

25 CONTACTS - VIEW B

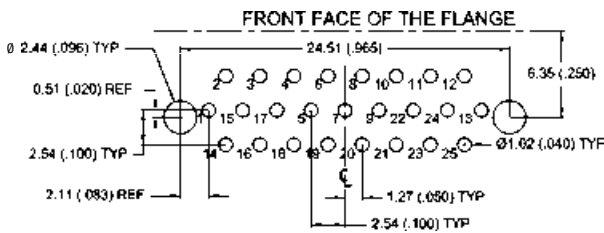

31 CONTACTS - VIEW B

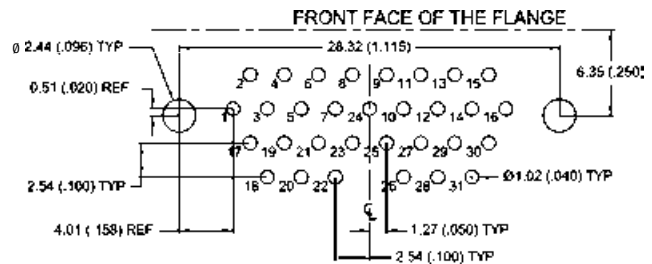

37 CONTACTS - VIEW B

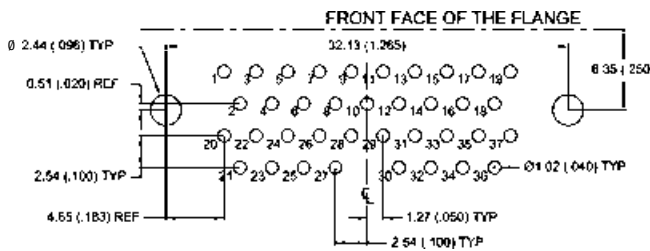

51 CONTACTS - VIEW B

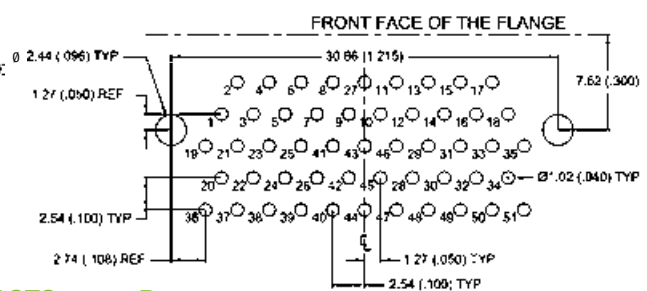

100 CONTACTS - VIEW B

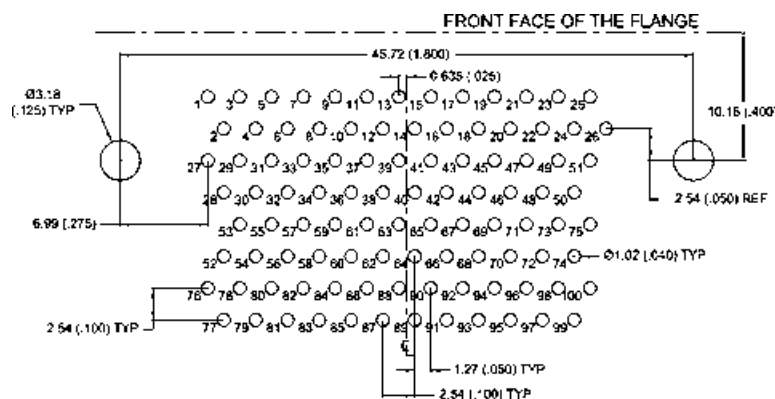

PCB LAYOUT FOR NARROW PROFILE, RIGHT ANGLE 0.100" PITCH - FEMALE CONNECTORS

VIEW A

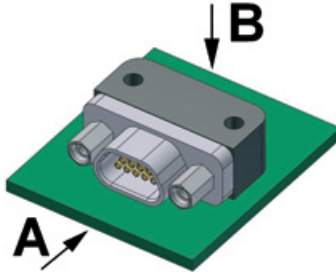
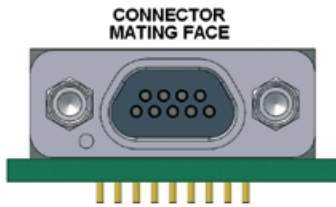

9 CONTACTS - VIEW B

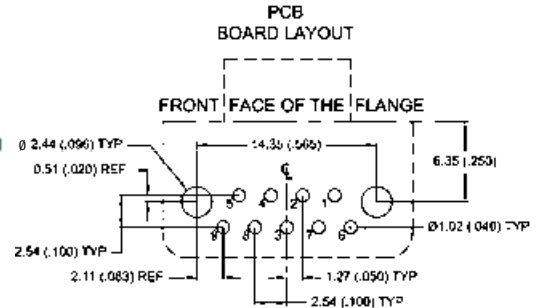

15 CONTACTS - VIEW B

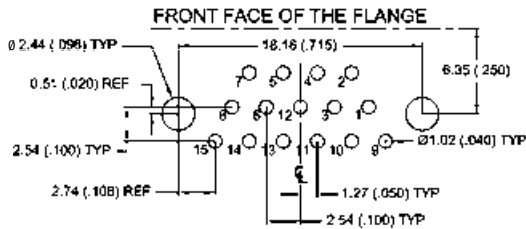

21 CONTACTS - VIEW B

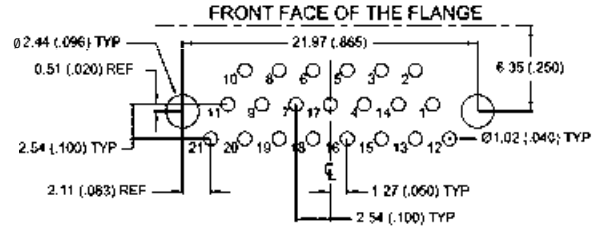

25 CONTACTS - VIEW B

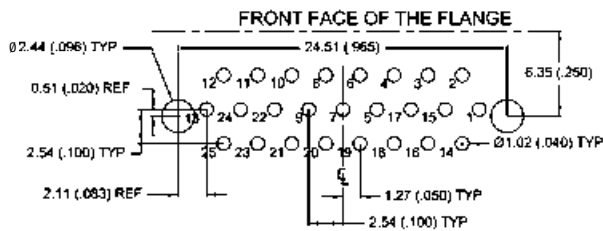

31 CONTACTS - VIEW B

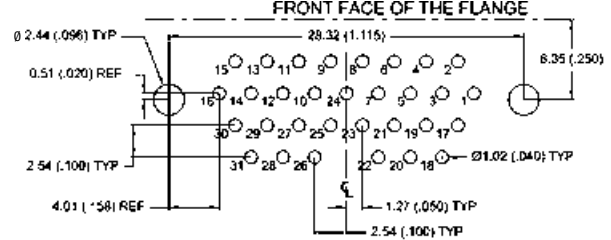

37 CONTACTS - VIEW B

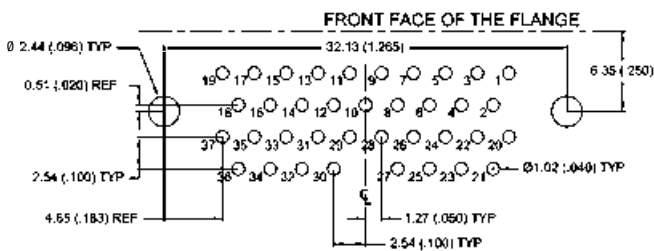

51 CONTACTS - VIEW B

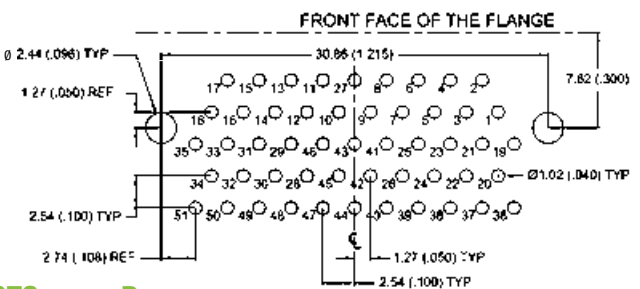

100 CONTACTS - VIEW B

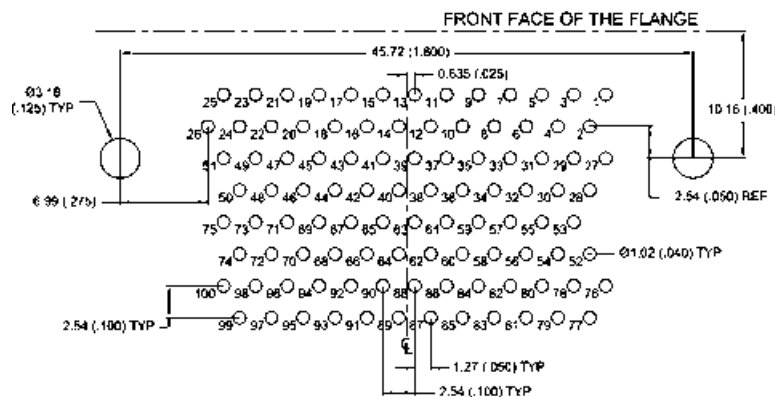



MIL-DTL-83513 /16 TO /21

PCB CONNECTOR

STANDARD PROFILE RIGHT ANGLE 0.100" PITCH

METAL SHELL

- Only available in metal shell version.
- Environmentally sealed.
- Board right angle connector for flexible and rigid printed circuit boards.
- Several tail lengths available.

CAGE CODE: OK0J2

IDENTIFICATION CODE

M83513/	20-G	03	N	P
---------	------	----	---	---

SERIES

M83513/: QPL series.

TYPE

- 16-A**: Pin connector, metal shell, 9 contacts.
- 16-B**: Pin connector, metal shell, 15 contacts.
- 16-C**: Pin connector, metal shell, 21 contacts.
- 16-D**: Pin connector, metal shell, 25 contacts.
- 16-E**: Pin connector, metal shell, 31 contacts.
- 16-F**: Pin connector, metal shell, 37 contacts.
- 17-G**: Pin connector, metal shell, 51 contacts.
- 18-H**: Pin connector, metal shell, 100 contacts.
- 19-A**: Socket connector, metal shell, 9 contacts.
- 19-B**: Socket connector, metal shell, 15 contacts.
- 19-C**: Socket connector, metal shell, 21 contacts.
- 19-D**: Socket connector, metal shell, 25 contacts.
- 19-E**: Socket connector, metal shell, 31 contacts.
- 19-F**: Socket connector, metal shell, 37 contacts.
- 20-G**: Socket connector, metal shell, 51 contacts.
- 21-H**: Socket connector, metal shell, 100 contacts.

See pages 26 & 27 for contact arrangements.

TERMINATION LENGTH

- 01**: 2.80 mm (.109").
 - 02**: 3.56 mm (.140").
 - 03**: 4.37 mm (.172").
- Tolerance ± 0.13 mm (.005").*

SHELL FINISH

- C**: Cadmium plating.
- N**: Nickel plating.
- P**: Passivated stainless steel.

HARDWARE CODE

- N**: No jackpost or threaded insert.
- P**: Jackpost installed.
- T**: Threaded inserts installed. For 16-A to 17-G and 19-A to 20-G only.
- W**: Jackpost and threaded inserts installed for 16-A to 17-G and 19-A to 20-G only.
- U**: Threaded inserts installed. For 18-H and 21-H only.
- Y**: Jackpost and threaded inserts installed. For 18-H and 21-H only.

METAL CONNECTORS ARE SUPPLIED WITH ANTI-STATIC PROTECTIVE DUST CAPS

DIMENSIONS

Dimensions are in millimetres (inches).

FEMALE connector

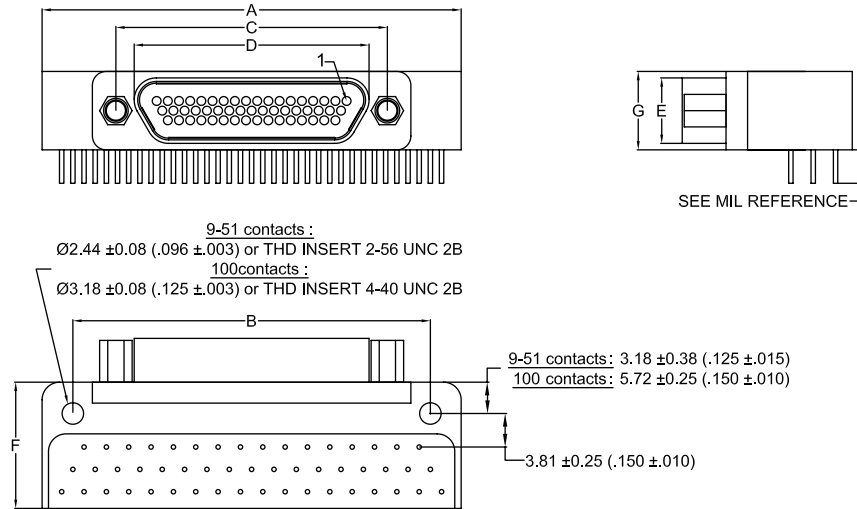

SEE CONTACT LAYOUT ON PCB PAGES 52 & 53

	A max.	B ± 0.18 (± 0.007)	C ± 0.13 (± 0.005)	D max.		E max.		F max.	G ± 0.25 (± 0.010)
				Male	Female	Male	Female		
9 P / 9 S	35.31 1.390	29.21 1.150	14.35 .565	8.48 .334	10.16 .400	4.69 .185	6.35 .250	11.81 .465	7.87 .310
15 P / 15 S	39.12 1.540	33.02 1.300	18.16 .715	12.29 .484	14.00 .551	4.69 .185	6.35 .250	11.81 .465	7.87 .310
21 P / 21 S	42.93 1.690	36.83 1.450	21.97 .865	16.10 .634	17.81 .701	4.69 .185	6.35 .250	11.81 .465	7.87 .310
25 P / 25 S	45.47 1.790	39.37 1.550	24.51 .965	18.64 .734	20.35 .801	4.69 .185	6.35 .250	11.81 .465	7.87 .310
31 P / 31 S	51.82 2.040	45.72 1.800	28.32 1.115	22.45 .883	24.16 .951	4.69 .185	6.35 .250	11.81 .465	7.87 .310
37 P / 37 S	59.44 2.340	53.34 2.100	32.13 1.265	26.26 1.034	27.96 1.101	4.69 .185	6.35 .250	11.81 .465	7.87 .310
51 P / 51 S	47.63 1.875	40.64 1.600	30.86 1.215	24.99 .984	26.70 1.051	5.79 .228	7.44 .293	14.35 .565	8.76 .345
100 P / 100 S	70.61 2.780	63.50 2.500	45.72 1.800	35.15 1.384	36.86 1.451	6.88 .271	8.46 .333	19.43 .765	10.29 .405

SUMMARY OF CHARACTERISTICS

ELECTRICAL & MECHANICAL PERFORMANCE	
CURRENT RATING	3 A max.
CONTACT RESISTANCE	8 m Ω max.
INSULATION RESISTANCE	5000 M Ω min. @ 500 V _{DC}
DIELECTRIC WITHSTANDING VOLTAGE	Sea level: 600 V _{AC}
CONTACT ENGAGING FORCE	Altitude 21 km (70,000 ft): 150 V _{AC}
CONTACT SEPARATING FORCE	170 g max. (6 oz)
CONTACT RETENTION	14 g min. (0.5 oz)
DURABILITY	2.26 kg (5 lbs)
VIBRATION	500 mating cycles min.
SHOCK	20g's – No discontinuity > 1 μ s
	50g's – No discontinuity > 1 μ s

MATERIAL & FINISH	
SHELL	Aluminium Alloy 6061 or 300 series stainless steel, see ordering info for plating options
MOULDED INSULATOR	Liquid Crystal Polymer (LCP)
INTERFACIAL SEAL	Fluorosilicone rubber
PIN CONTACT	Copper and beryllium copper, gold over nickel plating
SOCKET CONTACT	Copper alloy, gold over nickel plating
ENCAPSULANT	Epoxy resin
MOULDED TRAY	Liquid Crystal Polymer (LCP)
PCB TERMINALS	AWG24 gold plated copper, solder dipped in 63/37 tin-lead
HARDWARE	300 series stainless steel, passivated

SEE PAGE 24 FOR MORE INFORMATION

PCB LAYOUT FOR STANDARD PROFILE, RIGHT ANGLE 0.100" PITCH - MALE CONNECTORS

VIEW A

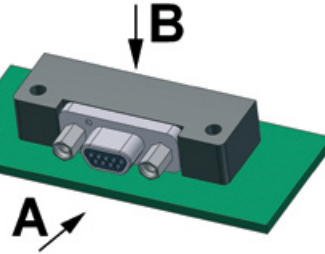

9 CONTACTS - VIEW B

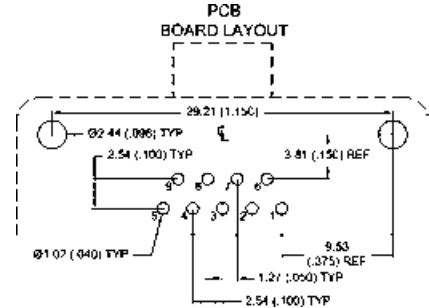

15 CONTACTS - VIEW B

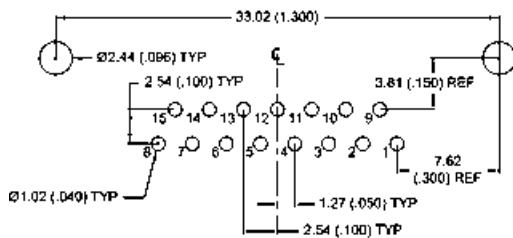

21 CONTACTS - VIEW B

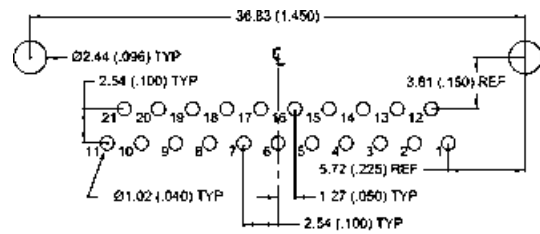

25 CONTACTS - VIEW B

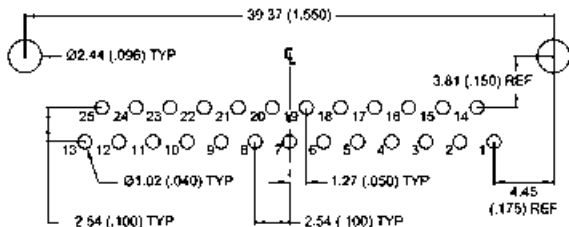

31 CONTACTS - VIEW B

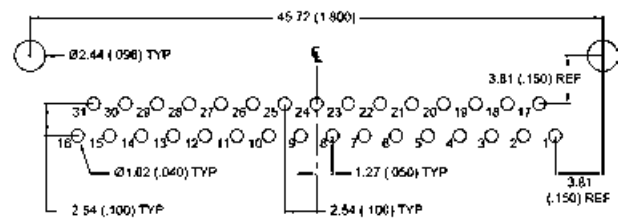

37 CONTACTS - VIEW B

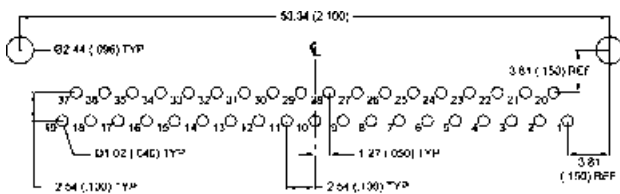

51 CONTACTS - VIEW B

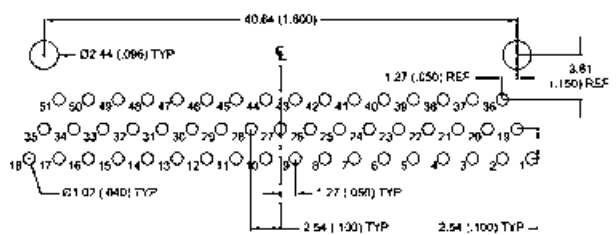

100 CONTACTS - VIEW B

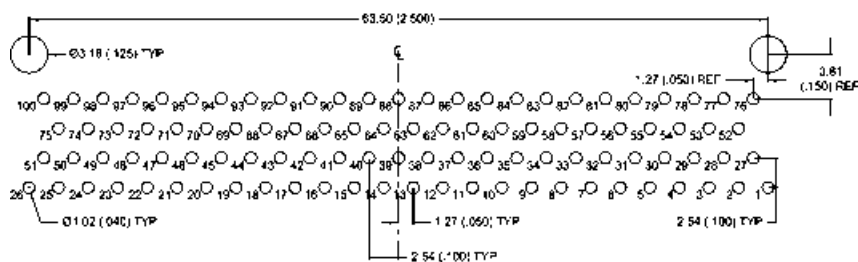

PCB LAYOUT FOR STANDARD PROFILE, RIGHT ANGLE 0.100" PITCH - FEMALE CONNECTORS

VIEW A

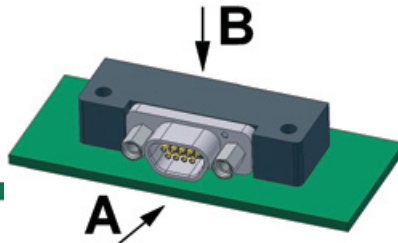

9 CONTACTS - VIEW B

PCB BOARD LAYOUT

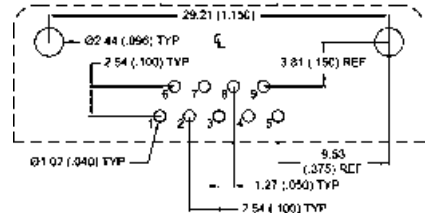

15 CONTACTS - VIEW B

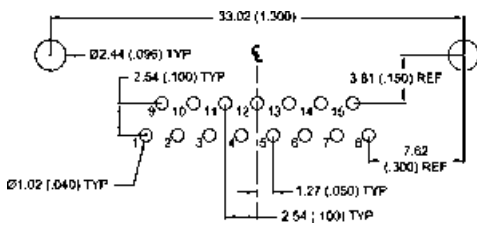

21 CONTACTS - VIEW B

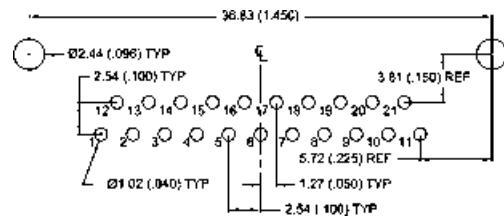

25 CONTACTS - VIEW B

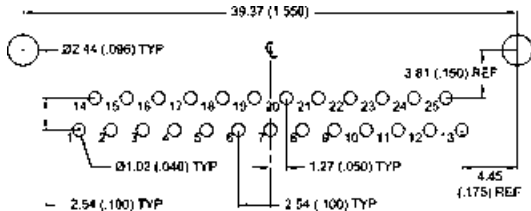

31 CONTACTS - VIEW B

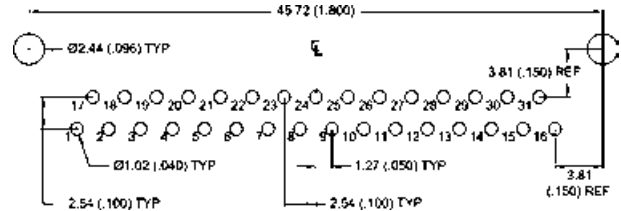

37 CONTACTS - VIEW B

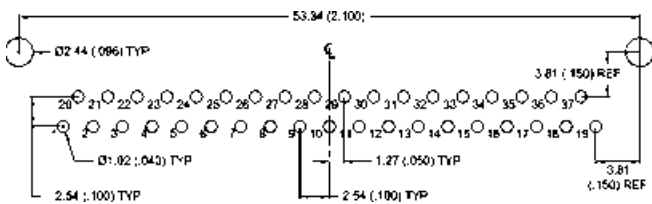

51 CONTACTS - VIEW B

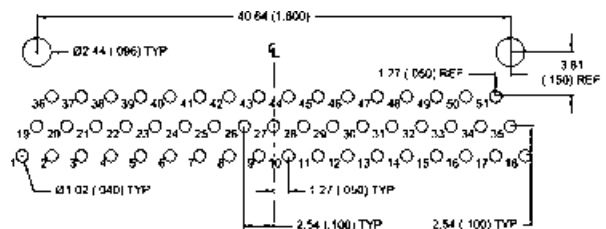

100 CONTACTS - VIEW B

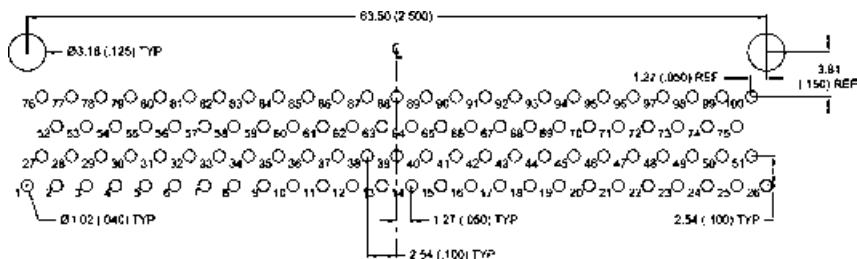

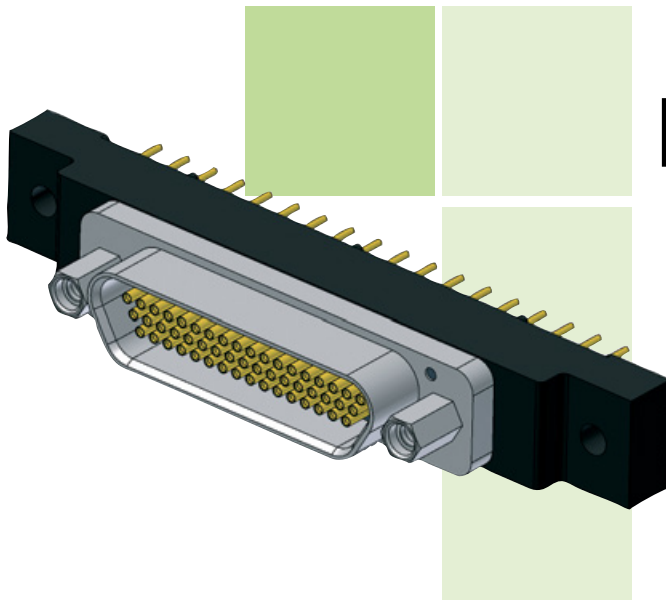

MIL-DTL-83513 /22 TO /27

PCB CONNECTOR

STRAIGHT 0.100" PITCH

METAL SHELL

- Only available in metal shell version.
- Environmentally sealed.
- Board straight connector for flexible and rigid printed circuit boards.
- Several tail lengths available.

CAGE CODE: OK0J2

IDENTIFICATION CODE

M83513/

26-G

03

N

P

SERIES

M83513/: QPL series.

TYPE

- 22-A**: Pin connector, metal shell, 9 contacts.
- 22-B**: Pin connector, metal shell, 15 contacts.
- 22-C**: Pin connector, metal shell, 21 contacts.
- 22-D**: Pin connector, metal shell, 25 contacts.
- 22-E**: Pin connector, metal shell, 31 contacts.
- 22-F**: Pin connector, metal shell, 37 contacts.
- 22-G**: Pin connector, metal shell, 51 contacts.
- 23-G**: Pin connector, metal shell, 51 contacts.
- 24-H**: Pin connector, metal shell, 100 contacts.
- 25-A**: Socket connector, metal shell, 9 contacts.
- 25-B**: Socket connector, metal shell, 15 contacts.
- 25-C**: Socket connector, metal shell, 21 contacts.
- 25-D**: Socket connector, metal shell, 25 contacts.
- 25-E**: Socket connector, metal shell, 31 contacts.
- 25-F**: Socket connector, metal shell, 37 contacts.
- 25-G**: Socket connector, metal shell, 51 contacts.
- 26-G**: Socket connector, metal shell, 51 contacts.
- 27-H**: Socket connector, metal shell, 100 contacts.

See pages 26 & 27 for contact arrangements.

TERMINATION LENGTH

01: 2.80 mm (.109").

02: 3.56 mm (.140").

03: 4.37 mm (.172").

Tolerance ± 0.13 mm (.005").

SHELL FINISH

C: Cadmium plating.

N: Nickel plating.

P: Passivated stainless steel.

HARDWARE CODE

N: No jackpost or threaded insert.

P: Jackpost installed.

T: Threaded inserts installed for 22-A to 23-G and 25-A to 26-G only.

W: Jackpost and threaded inserts installed for 22-A to 23-G and 25-A to 26-G only.

U: Threaded inserts installed. For 24-H and 27-H only.

Y: Jackpost and threaded inserts installed. For 24-H and 27-H only.

METAL CONNECTORS ARE SUPPLIED WITH ANTI-STATIC PROTECTIVE DUST CAPS

DIMENSIONS

Dimensions are in millimetres (inches).

FEMALE connector

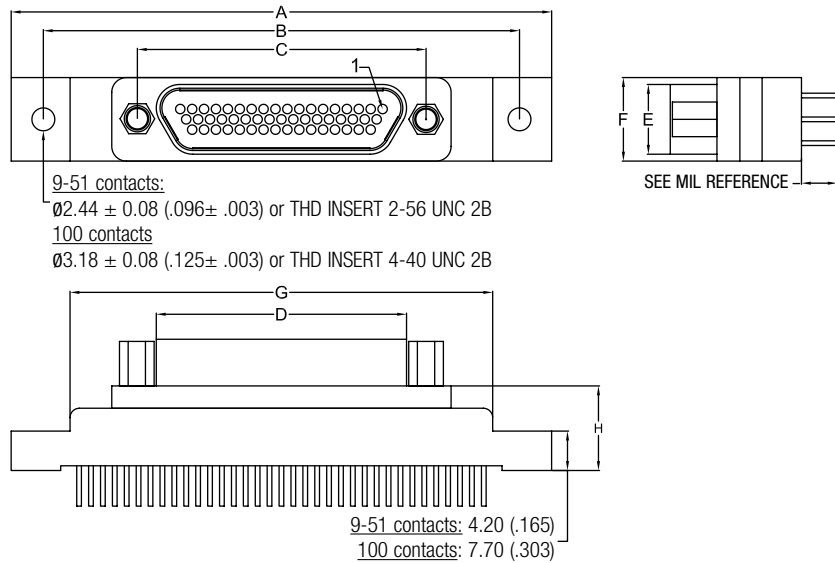

SEE CONTACT LAYOUT ON PCB PAGES 56 & 57

	A max.	B ± 0.18 ($\pm .007$)	C ± 0.13 ($\pm .005$)	D max.		E max.		F max.	G max.	H max.
				Male	Female	Male	Female			
9 P / 9 S	35.31 1.390	29.21 1.150	14.35 .565	8.48 .334	10.16 .400	4.69 .185	6.35 .250	7.82 .308	19.94 .785	9.02 .355
15 P / 15 S	35.31 1.390	29.21 1.150	18.16 .715	12.29 .484	14.00 .551	4.69 .185	6.35 .250	7.82 .308	24.00 .945	9.02 .355
21 P / 21 S	42.93 1.690	36.83 1.450	21.97 .865	16.10 .634	17.81 .701	4.69 .185	6.35 .250	7.82 .308	29.72 1.170	9.02 .355
25 P / 25 S	44.20 1.740	38.10 1.500	24.51 .965	18.64 .734	20.35 .801	4.69 .185	6.35 .250	7.82 .308	32.39 1.275	9.02 .355
31 P / 31 S	51.82 2.040	45.72 1.800	28.32 1.115	22.45 .883	24.16 .951	4.69 .185	6.35 .250	7.82 .308	40.01 1.575	9.02 .355
37 P / 37 S	59.44 2.340	53.34 2.100	32.13 1.265	26.26 1.034	27.96 1.101	4.69 .185	6.35 .250	7.82 .308	47.63 1.875	9.02 .355
51 P / 51 S	57.66 2.270	50.80 2.000	30.86 1.215	24.99 .984	26.70 1.051	5.79 .228	7.44 .293	8.92 .351	45.09 1.775	9.02 .355
100 P / 100 S	82.55 3.250	71.12 2.800	45.72 1.800	35.15 1.384	36.86 1.451	6.88 .271	8.46 .333	11.68 .460	65.66 2.585	13.97 .550

SUMMARY OF CHARACTERISTICS

ELECTRICAL & MECHANICAL PERFORMANCE	
CURRENT RATING	3 A max.
CONTACT RESISTANCE	8 m Ω max.
INSULATION RESISTANCE	5000 M Ω min. @ 500 V _{dc}
DIELECTRIC WITHSTANDING VOLTAGE	Sea level: 600 V _{ac} Altitude 21 km (70,000 ft): 150 V _{ac}
CONTACT ENGAGING FORCE	170 g max. (6 oz)
CONTACT SEPARATING FORCE	14 g min. (0.5 oz)
CONTACT RETENTION	2.26 kg (5 lbs)
DURABILITY	500 mating cycles min.
VIBRATION	20g's - No discontinuity > 1 μ s
SHOCK	50g's - No discontinuity > 1 μ s

MATERIAL & FINISH	
SHELL	Aluminium Alloy 6061 or 300 series stainless steel, see ordering info for plating options
MOULDED INSULATOR	Liquid Crystal Polymer (LCP)
INTERFACIAL SEAL	Fluorosilicone rubber
PIN CONTACT	Copper and beryllium copper, gold over nickel plating
SOCKET CONTACT	Copper alloy, gold over nickel plating
ENCAPSULANT	Epoxy resin
MOULDED TRAY	Liquid Crystal Polymer (LCP)
PCB TERMINALS	AWG24 gold plated copper, solder dipped in 63/37 tin-lead
HARDWARE	300 series stainless steel, passivated

SEE PAGE 24 FOR MORE INFORMATION

MIL-DTL-83513 /22 TO /27

PCB LAYOUT FOR STRAIGHT
0.100" PITCH - MALE CONNECTORS

VIEW A

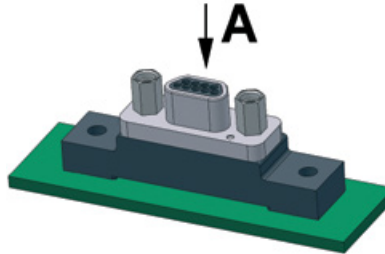

9 CONTACTS - VIEW A

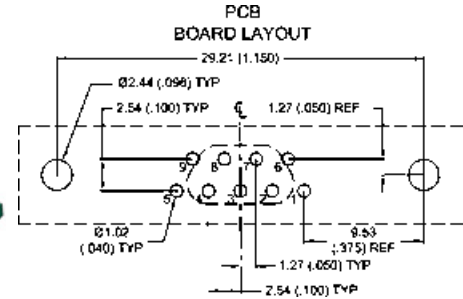

15 CONTACTS - VIEW A

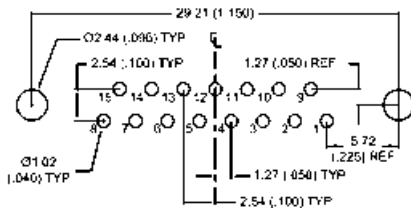

21 CONTACTS - VIEW A

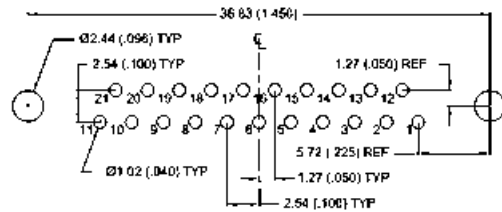

25 CONTACTS - VIEW A

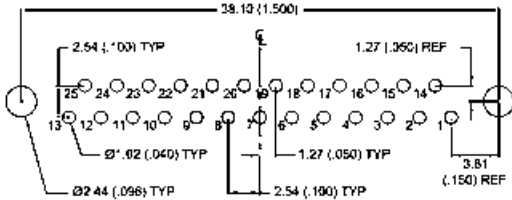

31 CONTACTS - VIEW A

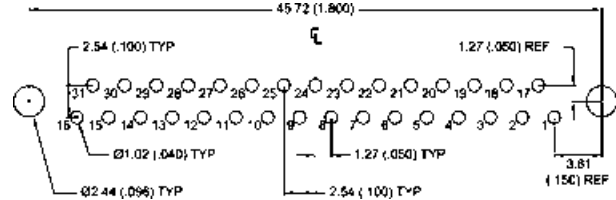

37 CONTACTS - VIEW A

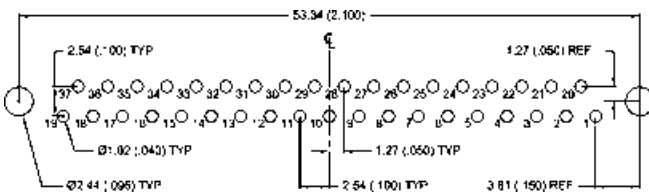

51 CONTACTS - VIEW A

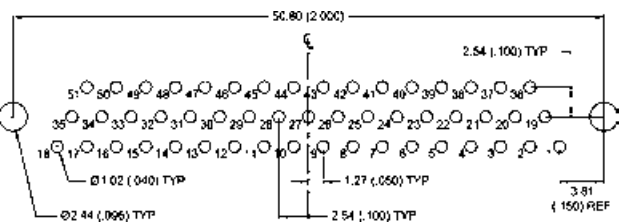

100 CONTACTS - VIEW A

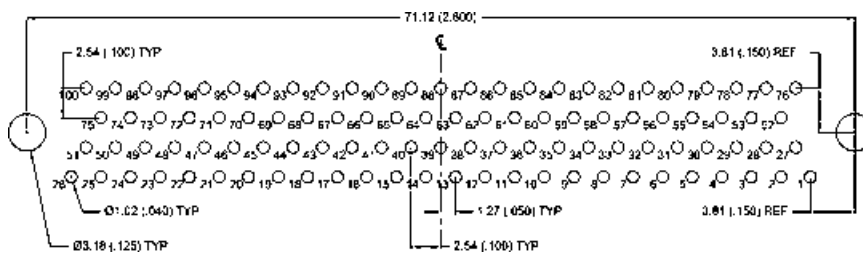

PCB LAYOUT FOR STRAIGHT, 0.100" PITCH - FEMALE CONNECTORS

VIEW A

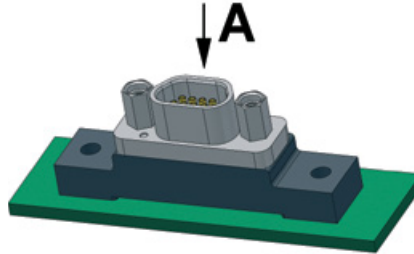

9 CONTACTS - VIEW A

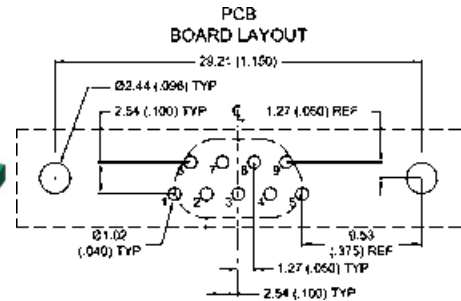

15 CONTACTS - VIEW A

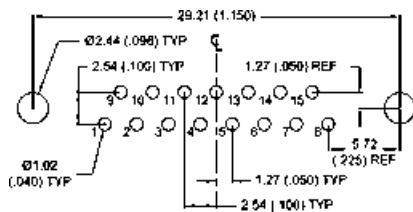

21 CONTACTS - VIEW A

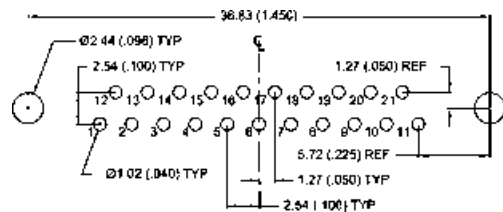

25 CONTACTS - VIEW A

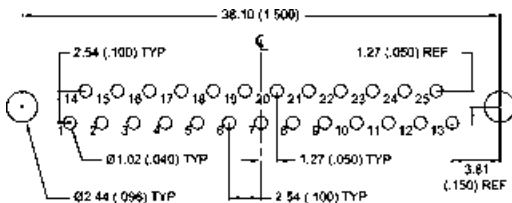

31 CONTACTS - VIEW A

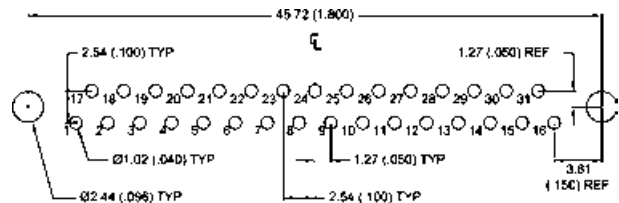

37 CONTACTS - VIEW A

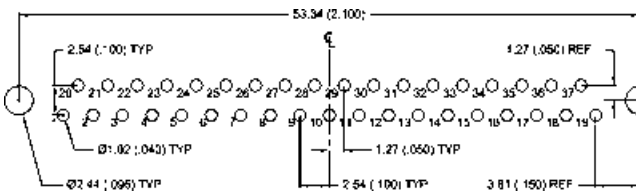

51 CONTACTS - VIEW A

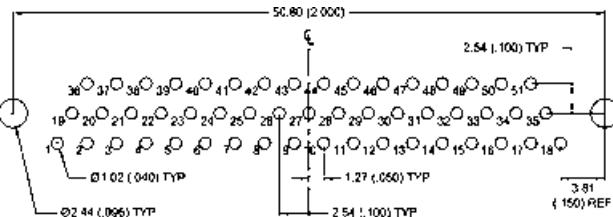

100 CONTACTS - VIEW A

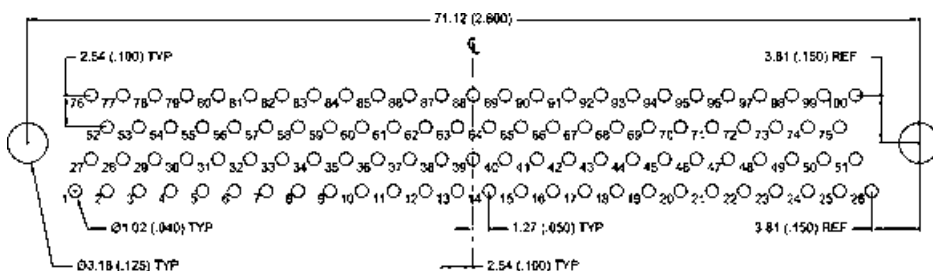

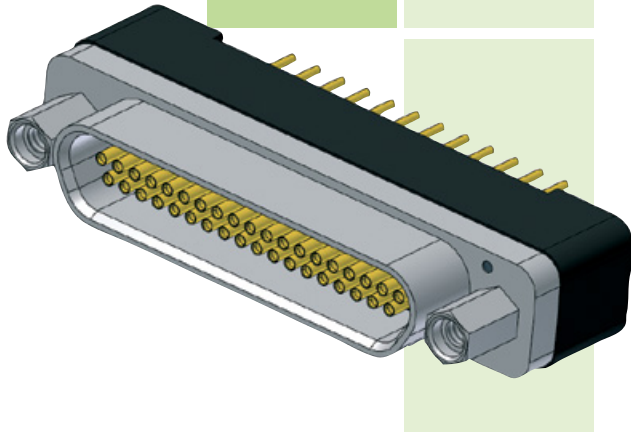

MIL-DTL-83513 /28 TO /33

PCB CONNECTOR

STRAIGHT 0.075" PITCH

METAL SHELL

- Only available in metal shell version.
- Environmentally sealed.
- Board straight connector for flexible and rigid printed circuit boards.
- Several tail lengths available.

CAGE CODE: OK0J2

IDENTIFICATION CODE

M83513/

31-F

03

N

W

SERIES

M83513/: QPL series.

TYPE

- 28-A**: Pin connector, metal shell, 9 contacts.
- 28-B**: Pin connector, metal shell, 15 contacts.
- 28-C**: Pin connector, metal shell, 21 contacts.
- 28-D**: Pin connector, metal shell, 25 contacts.
- 28-E**: Pin connector, metal shell, 31 contacts.
- 28-F**: Pin connector, metal shell, 37 contacts.
- 29-G**: Pin connector, metal shell, 51 contacts.
- 30-H**: Pin connector, metal shell, 100 contacts.
- 31-A**: Socket connector, metal shell, 9 contacts.
- 31-B**: Socket connector, metal shell, 15 contacts.
- 31-C**: Socket connector, metal shell, 21 contacts.
- 31-D**: Socket connector, metal shell, 25 contacts.
- 31-E**: Socket connector, metal shell, 31 contacts.
- 31-F**: Socket connector, metal shell, 37 contacts.
- 32-G**: Socket connector, metal shell, 51 contacts.
- 33-H**: Socket connector, metal shell, 100 contacts.

See pages 26 & 27 for contact arrangements.

TERMINATION LENGTH

01: 2.80 mm (.109").

02: 3.56 mm (.140").

03: 4.37 mm (.172").

Tolerance ± 0.13 mm (.005").

SHELL FINISH

C: Cadmium plating.

N: Nickel plating.

P: Passivated stainless steel.

HARDWARE CODE

N: No jackpost or threaded insert.

P: Jackpost installed.

T: Threaded inserts installed. For 28-A to 29-G and 31-A to 32-G only.

W: Jackpost and threaded inserts installed for 28-A to 29-G and 31-A to 32-G only.

U: Threaded inserts installed. For 30-H and 33-H only.

Y: Jackpost and threaded inserts installed. For 30-H and 33-H only.

Hardware Code **P**:
Long jackpost and
thru-hole

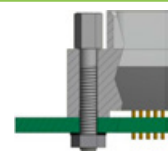

METAL CONNECTORS ARE SUPPLIED WITH ANTI-STATIC PROTECTIVE DUST CAPS

DIMENSIONS

Dimensions are in millimetres (inches).

FEMALE connector

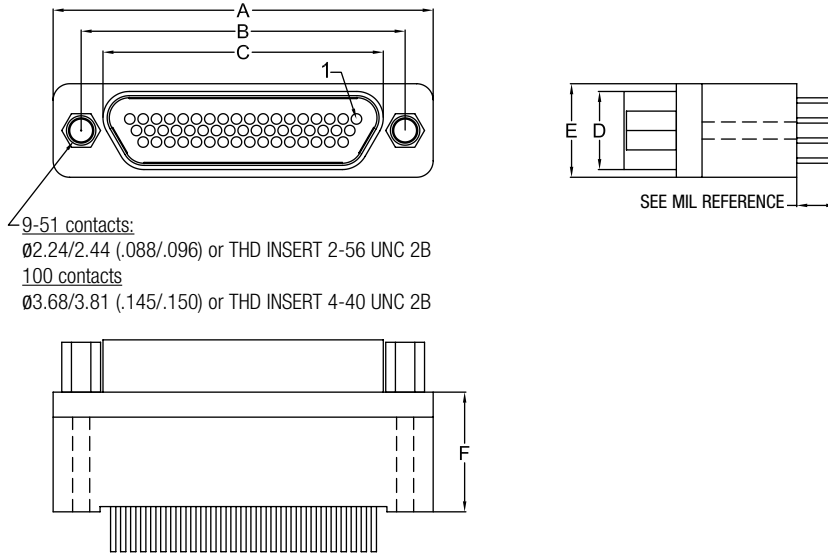

9-51 contacts:
 Ø2.24/2.44 (.088/.096) or THD INSERT 2-56 UNC 2B
 100 contacts
 Ø3.68/3.81 (.145/.150) or THD INSERT 4-40 UNC 2B

SEE CONTACT LAYOUT ON PCB PAGES 60 & 61

	A max.	B ± 0.13 (±.005)	C max.		D max.		E max.	F max.
			Male	Female	Male	Female		
9 P / 9 S	19.94 .785	14.35 .565	8.48 .334	10.16 .400	4.69 .185	6.35 .250	7.87 .310	9.02 .355
15 P / 15 S	23.75 .935	18.16 .715	12.29 .484	14.00 .551	4.69 .185	6.35 .250	7.87 .310	9.02 .355
21 P / 21 S	27.56 1.085	21.97 .865	16.10 .634	17.81 .701	4.69 .185	6.35 .250	7.87 .310	9.02 .355
25 P / 25 S	30.10 1.185	24.51 .965	18.64 .734	20.35 .801	4.69 .185	6.35 .250	7.87 .310	9.02 .355
31 P / 31 S	33.91 1.335	28.32 1.115	22.45 .883	24.16 .951	4.69 .185	6.35 .250	7.87 .310	9.02 .355
37 P / 37 S	37.72 1.485	32.13 1.265	26.26 1.034	27.96 1.101	4.69 .185	6.35 .250	7.87 .310	9.02 .355
51 P / 51 S	36.45 1.435	30.86 1.215	24.99 .984	26.70 1.051	5.79 .228	7.44 .293	10.16 .400	9.02 .355
100 P / 100 S	55.12 2.170	45.72 1.800	35.15 1.384	36.86 1.451	6.88 .271	8.46 .333	12.95 .510	10.92 .430

SUMMARY OF CHARACTERISTICS

ELECTRICAL & MECHANICAL PERFORMANCE	
CURRENT RATING	3 A max.
CONTACT RESISTANCE	8 mΩ max.
INSULATION RESISTANCE	5000 MΩ min. @ 500 V _{dc}
DIELECTRIC WITHSTANDING VOLTAGE	Sea level: 600 V _{ac} Altitude 21 km (70,000 ft): 150 V _{ac}
CONTACT ENGAGING FORCE	170 g max. (6 oz)
CONTACT SEPARATING FORCE	14 g min. (0.5 oz)
CONTACT RETENTION	2.26 kg (5 lbs)
DURABILITY	500 mating cycles min.
VIBRATION	20g's – No discontinuity > 1 μs
SHOCK	50g's – No discontinuity > 1 μs

MATERIAL & FINISH	
SHELL	Aluminium Alloy 6061 or 300 series stainless steel, see ordering info for plating options
MOULDED INSULATOR	Liquid Crystal Polymer (LCP)
INTERFACIAL SEAL	Fluorosilicone rubber
PIN CONTACT	Copper and beryllium copper, gold over nickel plating
SOCKET CONTACT	Copper alloy, gold over nickel plating
ENCAPSULANT	Epoxy resin
MOULDED TRAY	Liquid Crystal Polymer (LCP)
PCB TERMINALS	AWG24 gold plated copper, solder dipped in 63/37 tin-lead
HARDWARE	300 series stainless steel, passivated

SEE PAGE 24 FOR MORE INFORMATION

PCB LAYOUT FOR QPL STRAIGHT 0.075" PITCH - MALE CONNECTORS

MIL-DTL-83513
CONNECTORS
Rectangular
Micro-D connectors

VIEW A

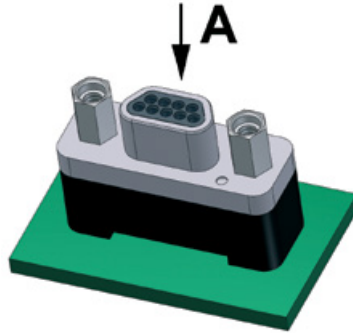

9 CONTACTS - VIEW A

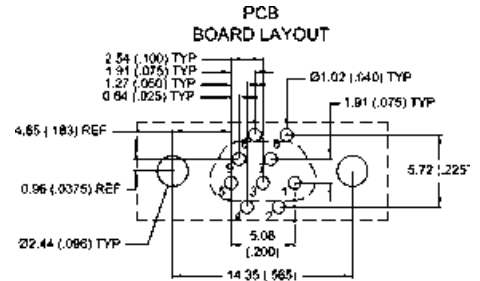

15 CONTACTS - VIEW A

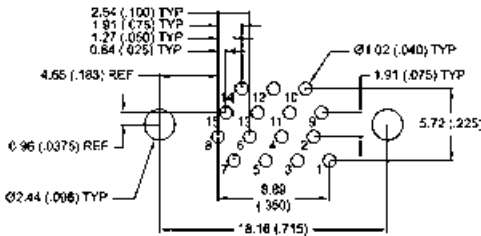

21 CONTACTS - VIEW A

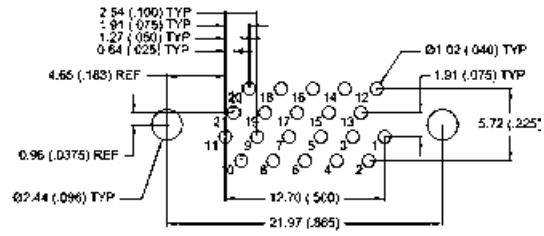

25 CONTACTS - VIEW A

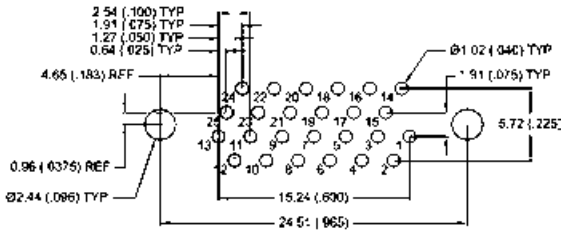

31 CONTACTS - VIEW A

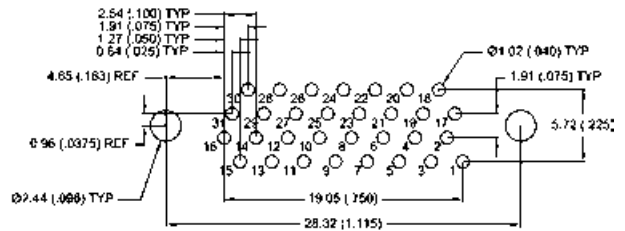

37 CONTACTS - VIEW A

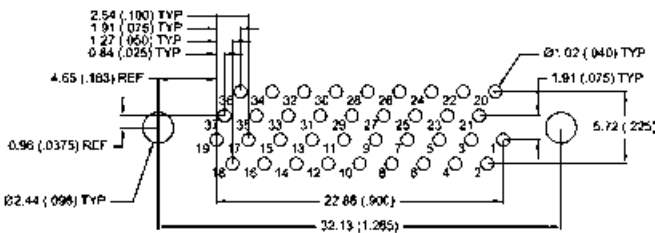

51 CONTACTS - VIEW A

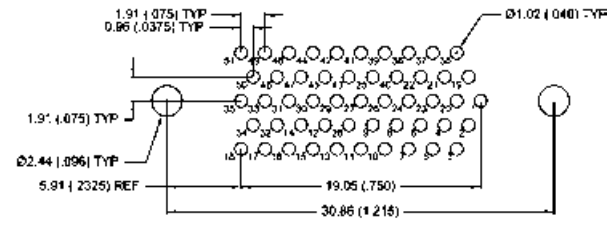

100 CONTACTS - VIEW A

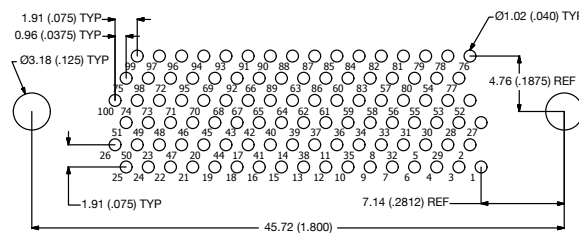

PCB LAYOUT FOR QPL STRAIGHT 0.075" PITCH - FEMALE CONNECTORS

VIEW A

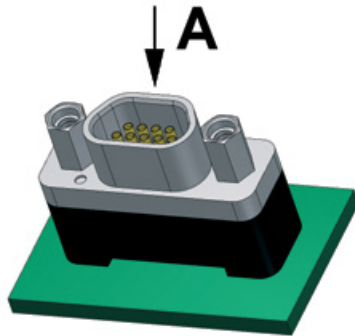

9 CONTACTS - VIEW A

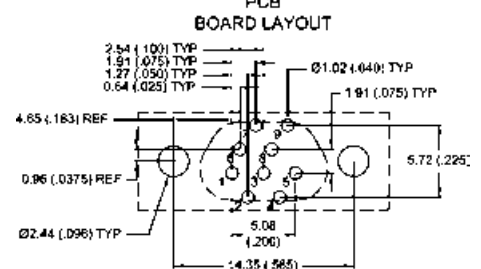

15 CONTACTS - VIEW A

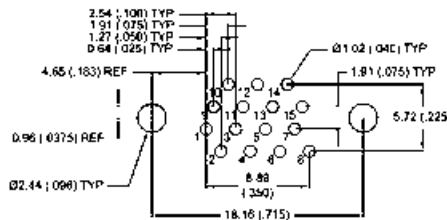

21 CONTACTS - VIEW A

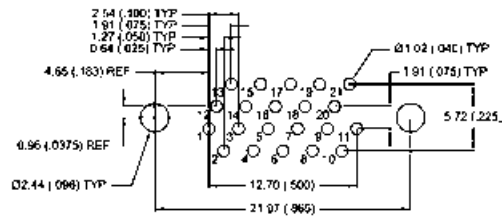

25 CONTACTS - VIEW A

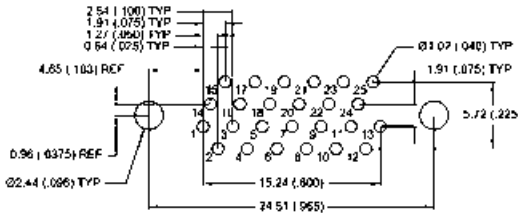

31 CONTACTS - VIEW A

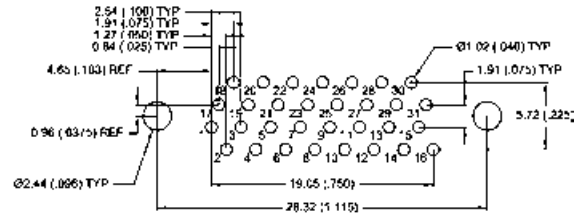

37 CONTACTS - VIEW A

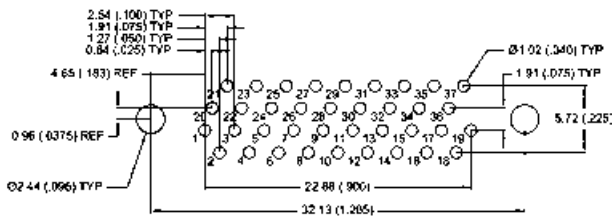

51 CONTACTS - VIEW A

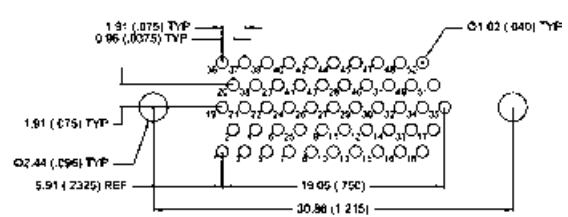

100 CONTACTS - VIEW A

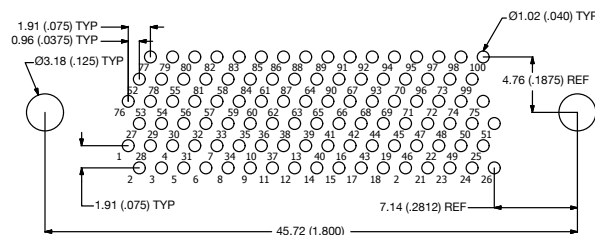

PIGTAILS, SOLDER CUP, PCB, SAVERS & MICROSTRIP CONNECTORS

RECTANGULAR CONNECTORS

- Pigtail connector - Metal shell 64
- Pigtail connector - Low profile - Metal shell 66
- Pigtail connector - Plastic shell 68
- Solder cup connector - Metal shell 70
- Solder cup connector - Low profile - Metal shell 72
- Solder cup connector - Plastic shell 74

PCB RECTANGULAR CONNECTORS

- PCB connectors overview 76
- CBR (Condensed Board Right Angle) type - 0.100" pitch
Metal shell 78
- CBR (Condensed Board Right Angle) type - 0.100" pitch
Plastic shell 80
PCB layout for CBR type 82
- CBP (Condensed Board Right Angle) type - 0.100" pitch
Low profile - Metal shell 86
- CBP (Condensed Board Right Angle) type - 0.100" pitch
Low profile - Plastic shell 88
PCB layout for CBP type 90
- BR (Board Right Angle) type - 0.100" pitch - Metal shell 92
PCB layout for BR type 94
- BS (Board Straight) type - 0.100" pitch - Metal shell 98
- BS (Board Straight) type - 0.100" pitch - Plastic shell 100
PCB layout for BS type 102
- CBR (Condensed Board Right Angle) type - 0.075" pitch Metal shell . 106
PCB layout for CBR 0.075" type. 108
- CBR (Condensed Board Right Angle) type - 0.075" pitch
Metal shell - Based on BS MIL standard layout 112
PCB layout for CBR 0.075" type – Based on BS MIL standard layout 114
- BS (Board Straight) type - 0.075" pitch - Metal shell 116
- BS (Board Straight) type - 0.075" pitch - Plastic shell 118
PCB layout for BS 0.075" type – MIL standard layout 120
PCB layout for BS 0.075" type – Specific layout – Plugs 122
PCB layout for BS 0.075" type – Specific layout – Receptacles 124

CONNECTOR SAVERS

- One piece design - Metal or plastic shell 126
- One piece design - Low profile - Metal shell 127
- Back to back assembly - Metal or plastic shell 128
- Back to back assembly - Low profile - Metal shell 129

MICROSTRIP CONNECTORS

- Pigtail & solder cup assemblies 130
- PCB connectors 132
- Microstrip general information 134
PCB layout for microstrip connectors 137

- HIGH DENSITY CONNECTORS 140



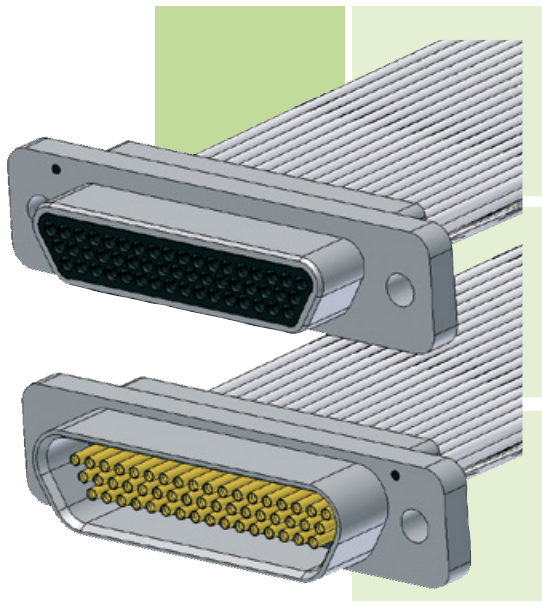

RECTANGULAR CONNECTORS

PIGTAIL CONNECTOR

METAL SHELL

- High performance metal connector and PTFE wire.
- Environmentally sealed.
- Operating temperature: 150°C or 200°C.
- 9 to 100 contacts.

IDENTIFICATION CODE



SERIES

MDA: Micro-D AXON' standard series.

CONNECTOR TYPE

- 1: Cadmium al. shell / Z: Black zinc nickel aluminium shell + potting 150°C.
- 2: Nickel aluminium shell + potting 150°C.
- 3: Nickel aluminium shell + potting 200°C.
- S: Passivated stainless steel shell + potting 200°C.

NUMBER OF CONTACTS 09, 15, 21, 25, 31, 37, 51DR, 51, 69, 100.
See pages 26 & 27 for contact arrangements.

CONNECTOR GENDER

- P: Male (pin contacts).
- S: Female (socket contacts).

WIRE TYPE

- For colour codes F, L, W
- 1: E 2607, AWG 26, 7 strands, 600V.
 - 4: E 2619, AWG 26, 19 strands, 600V.
 - 6: E 2807, AWG 28, 7 strands, 600V.
 - 8: E 3007, AWG 30, 7 strands, 600V.
 - A: E 2407, AWG 24, 7 strands, 600V.
 - C: E 2419, AWG 24, 19 strands, 600V.
 - E: M22759/33, AWG 26, 19 strands, 600V.
- For colour code V only
- 3: M22759/11, AWG26, 19 strands, 600V.
- F: E2607, AWG26, 7 strands, 600V.
Solid uninsulated wires
- G: AWG 25 gold plated.
 - T: AWG 24 tin plated.
- See page 29 for wire types.

COLOUR CODE

- F: All yellow.
 - L: All white.
 - BLANK: If wire type is G or T.
 - W: 10 colour repeat.
 - V: MIL-STD-681 striped (only for wire types 3 and F).
- See page 30 for colour code.

WIRE LENGTH (in cm)

Attention! Wire length in centimetres - (1cm = 10mm = 0.394").

L	L ≤ 10	10 < L ≤ 100	L > 100
in cm (inches)	L ≤ 3.940	3.940 < L ≤ 39.40	L > 39.40
TOLERANCE	-0 / +0.5	-0 / +3	-0 / +5
in cm (inches)	-0 / +0.200	-0 / +1.180	-0 / +1.970

HARDWARE

- B: No hardware.
 - C: U-clips with low profile hex socket head jackscrews (removable).
 - D: U-clips with low profile slot head jackscrews (removable).
 - M: Low profile hex socket head jackscrews (removable).
 - N: High profile hex socket head jackscrews (removable).
 - S: Low profile slot head jackscrews (removable).
 - T: High profile slot head jackscrews (removable).
 - P: Jackposts (removable).
 - Px (x: 1 to 5): Panel mount jackposts.
 - K: High profile slot head jackscrews (non removable).
 - L: Low profile hex socket head jackscrews (non removable).
 - F: Float mount, front panel mount (non removable).
 - FR: Float mount, rear panel mount (non removable).
- See pages 190 to 200 for hardware description.

METAL CONNECTORS ARE SUPPLIED WITH ANTI-STATIC PROTECTIVE DUST CAPS



DIMENSIONS

Dimensions are in millimetres (inches).

MALE connector

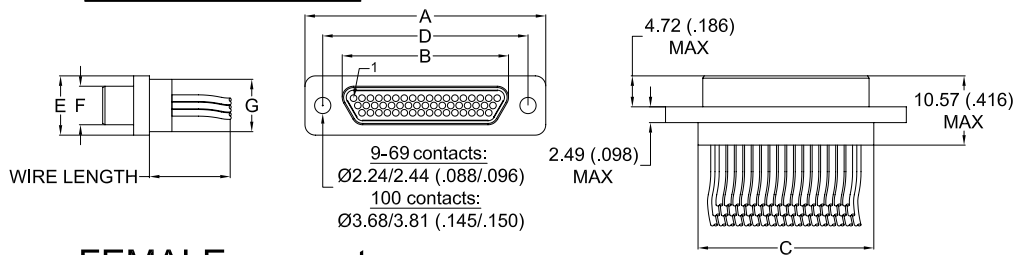

FEMALE connector

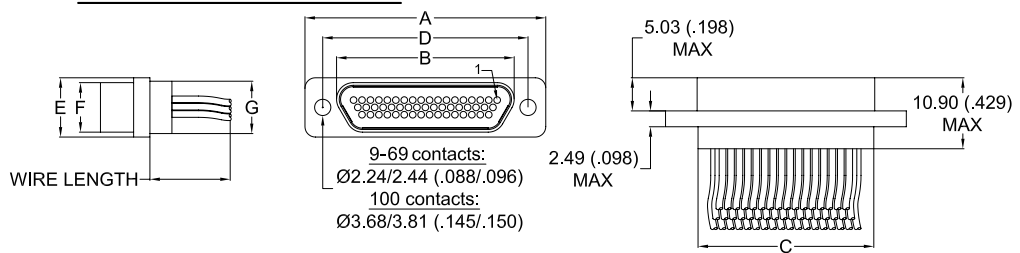

	A ± 0.25 (±.010)	B max.		C -0.46/+0.25 (-.018/+.010)	D ± 0.13 (±.005)	E ± 0.25 (±.010)	F max.		G max.
		Male	Female				Male	Female	
9 P / 9 S	19.69 .775	8.48 .334	10.16 .400	9.91 .390	14.35 .565	7.57 .298	4.69 .185	6.35 .250	6.86 .270
15 P / 15 S	23.50 .925	12.29 .484	14.00 .551	13.72 .540	18.16 .715	7.57 .298	4.69 .185	6.35 .250	6.86 .270
21 P / 21 S	27.31 1.075	16.10 .634	17.81 .701	17.53 .690	21.97 .865	7.57 .298	4.69 .185	6.35 .250	6.86 .270
25 P / 25 S	29.85 1.175	18.64 .734	20.35 .801	20.07 .790	24.51 .965	7.57 .298	4.69 .185	6.35 .250	6.86 .270
31 P / 31 S	33.66 1.325	22.45 .884	24.16 .951	23.88 .940	28.32 1.115	7.57 .298	4.69 .185	6.35 .250	6.86 .270
37 P / 37 S	37.47 1.475	26.26 1.034	27.96 1.101	27.69 1.090	32.13 1.265	7.57 .298	4.69 .185	6.35 .250	6.86 .270
51DR P / 51DR S	46.36 1.825	35.15 1.384	36.83 1.450	36.58 1.440	41.02 1.615	7.57 .298	4.69 .185	6.35 .250	6.86 .270
51 P / 51 S	36.20 1.425	24.99 .984	26.70 1.051	26.42 1.040	30.86 1.215	8.66 .341	5.79 .228	7.44 .293	7.87 .310
69 P / 69 S	43.82 1.725	32.61 1.1284	34.29 1.350	34.04 1.340	38.48 1.515	8.66 .341	5.79 .228	7.44 .293	7.87 .310
100 P / 100 S	54.86 2.160	35.15 1.384	36.86 1.451	36.37 1.432	45.72 1.800	9.75 .384	6.88 .271	8.46 .333	9.14 .360

SUMMARY OF CHARACTERISTICS

ELECTRICAL & MECHANICAL PERFORMANCE	
CURRENT RATING	3 A max.
CONTACT RESISTANCE	8 mΩ max.
INSULATION RESISTANCE	5000 MΩ min. @ 500 Vdc
DIELECTRIC WITHSTANDING VOLTAGE	Sea level: 600 V _{ac} Altitude 21 km (70,000 ft): 150 V _{ac}
CONTACT ENGAGING FORCE	170 g max. (6 oz)
CONTACT SEPARATING FORCE	14 g min. (0.5 oz)
CONTACT RETENTION	2.26 kg (5 lbs)
DURABILITY	500 mating cycles min.
VIBRATION	20g's – No discontinuity > 1 μs
SHOCK	50g's – No discontinuity > 1 μs

MATERIAL & FINISH	
SHELL	Aluminium alloy 6061 or 300 series stainless steel, see ordering info for plating options
MOULDED INSULATOR	Liquid Crystal Polymer (LCP)
INTERFACIAL SEAL	Fluorosilicone rubber
PIN CONTACT	Copper and beryllium copper, gold over nickel plating
SOCKET CONTACT	Copper alloy, gold over nickel plating
ENCAPSULANT	Epoxy resin
HARDWARE	300 series stainless steel, passivated

SEE PAGE 24 FOR MORE INFORMATION



RECTANGULAR CONNECTORS

PIGTAIL CONNECTOR

LOW PROFILE METAL SHELL

- High performance metal connector and PTFE wire.
- Operating temperature: 150°C or 200°C.
- 9 to 51 contacts.

IDENTIFICATION CODE

MDA 2 L51 S 4 L 050 B

SERIES

MDA: Micro-D AXON® standard series.

CONNECTOR TYPE

- 1:** Cadmium aluminium shell / **Z:** Black zinc nickel aluminium shell + potting 150°C.
- 2:** Nickel aluminium shell + potting 150°C.
- 3:** Nickel aluminium shell + potting 200°C.
- S:** Passivated stainless steel shell + potting 200°C.

NUMBER OF CONTACTS L09, L15, L21, L25, L31, L37, L51.

See pages 26 & 27 for contact arrangements.

CONNECTOR GENDER

- P:** Male (pin contacts).
- S:** Female (socket contacts).

WIRE TYPE

- For colour codes **F, L, W**
- 1:** E 2607, AWG 26, 7 strands, 600V.
 - 4:** E 2619, AWG 26, 19 strands, 600V.
 - 6:** E 2807, AWG 28, 7 strands, 600V.
 - 8:** E 3007, AWG 30, 7 strands, 600V.
 - A:** E 2407, AWG 24, 7 strands, 600V.
 - C:** E 2419, AWG 24, 19 strands, 600V.
 - E:** M22759/33, AWG 26, 19 strands, 600V.
- For colour code **V** only
- 3:** M22759/11, AWG26, 19 strands, 600V.
- F:** E 2607, AWG 26, 7 strands, 600V.
Solid uninsulated wires
- G:** AWG 25 gold plated
 - T:** AWG 24 tin plated
- See page 29 for wire types.

COLOUR CODE

- F:** All yellow.
 - L:** All white.
 - BLANK:** If wire type is G or T.
 - W:** 10 colour repeat.
 - V:** MIL-STD-681 striped (only for wire types 3 and F).
- See page 30 for colour code.

WIRE LENGTH (in cm)

Attention! Wire length in centimetres - (1cm = 10mm = 0.394").

L	L ≤ 10	10 < L ≤ 100	L > 100
in cm (inches)	L ≤ 3.940	3.940 < L ≤ 39.40	L > 39.40
TOLERANCE	-0 / +0.5	-0 / +3	-0 / +5
in cm (inches)	-0 / +0.200	-0 / +1.180	-0 / +1.970

HARDWARE

- B:** No hardware.
 - C:** U-clips with low profile hex socket head jackscrews (removable).
 - D:** U-clips with low profile slot head jackscrews (removable).
 - M:** Low profile hex socket head jackscrews (removable).
 - N:** High profile hex socket head jackscrews (removable).
 - S:** Low profile slot head jackscrews (removable).
 - T:** High profile slot head jackscrews (removable).
 - P:** Jackposts (removable).
 - Px** (x: 1 to 5): Panel mount jackposts.
 - K:** High profile slot head jackscrews (non removable).
 - L:** Low profile hex socket head jackscrews (non removable).
 - F:** Float mount, front panel mount (non removable).
 - FR:** Float mount, rear panel mount (non removable).
- See pages 190 to 200 for hardware description.

METAL CONNECTORS ARE SUPPLIED WITH ANTI-STATIC PROTECTIVE DUST CAPS



DIMENSIONS

Dimensions are in millimetres (inches).

MALE connector

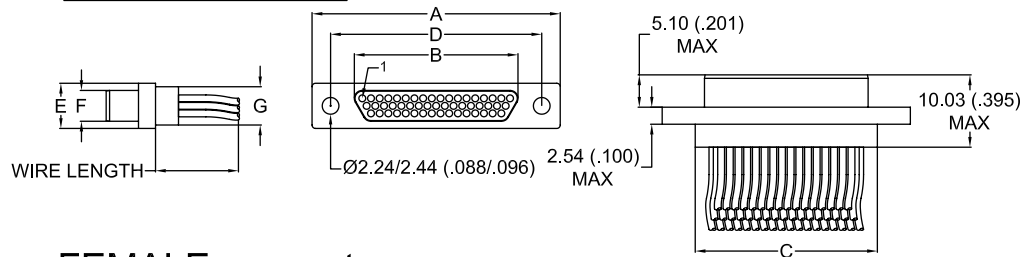

FEMALE connector

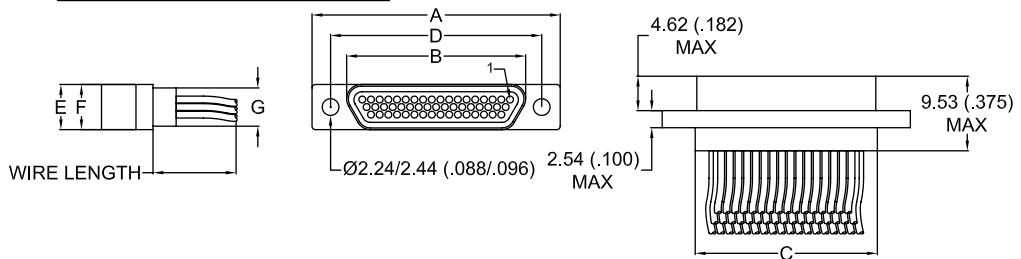

	A ± 0.25 (±.010)	B max.		C -0.46/+0.25 (-.018/+0.010)	D ± 0.13 (±.005)	E ± 0.25 (±.010)	F max.		G max.
		Male	Female				Male	Female	
9 P / 9 S	19.76 .778	7.47 .294	9.65 .380	10.11 .398	14.35 .565	5.28 .208	3.40 .134	5.53 .218	4.39 .173
15 P / 15 S	23.57 .928	11.28 .444	13.46 .530	13.92 .548	18.16 .715	5.28 .208	3.40 .134	5.53 .218	4.39 .173
21 P / 21 S	27.38 1.078	15.09 .594	17.27 .680	17.73 .698	21.97 .865	5.28 .208	3.40 .134	5.53 .218	4.39 .173
25 P / 25 S	29.92 1.178	17.63 .694	19.81 .780	20.27 .798	24.51 .965	5.28 .208	3.40 .134	5.53 .218	4.39 .173
31 P / 31 S	33.73 1.328	21.44 .844	23.62 .930	24.08 .948	28.32 1.115	5.28 .208	3.40 .134	5.53 .218	4.39 .173
37 P / 37 S	37.54 1.478	25.25 .994	27.43 1.080	27.89 1.098	32.13 1.265	5.28 .208	3.40 .134	5.53 .218	4.39 .173
51 P / 51 S	36.27 1.428	23.98 .944	26.16 1.030	26.62 1.048	30.86 1.215	6.35 .250	4.50 .177	6.60 .260	5.59 .220

SUMMARY OF CHARACTERISTICS

ELECTRICAL & MECHANICAL PERFORMANCE	
CURRENT RATING	3 A max.
CONTACT RESISTANCE	8 mΩ max.
INSULATION RESISTANCE	5000 MΩ min. @ 500 Vdc
DIELECTRIC WITHSTANDING VOLTAGE	Sea level: 600 V _{AC} Altitude 21 km (70,000 ft): 150 V _{AC}
CONTACT ENGAGING FORCE	170 g max. (6 oz)
CONTACT SEPARATING FORCE	14 g min. (0,5 oz)
CONTACT RETENTION	2,26 kg (5 lbs)
DURABILITY	500 mating cycles min.
VIBRATION	20g's - No discontinuity > 1μs
SHOCK	50g's - No discontinuity > 1μs

MATERIAL & FINISH	
SHELL	Aluminium alloy 6061 or 300 series stainless steel, see ordering info for plating options
MOULDED INSULATOR	Liquid Crystal Polymer (LCP)
PIN CONTACT	Copper and beryllium copper, gold over nickel plating
SOCKET CONTACT	Copper alloy, gold over nickel plating
ENCAPSULENT	Epoxy resin
HARDWARE	300 series stainless steel, passivated

SEE PAGE 24 FOR MORE INFORMATION

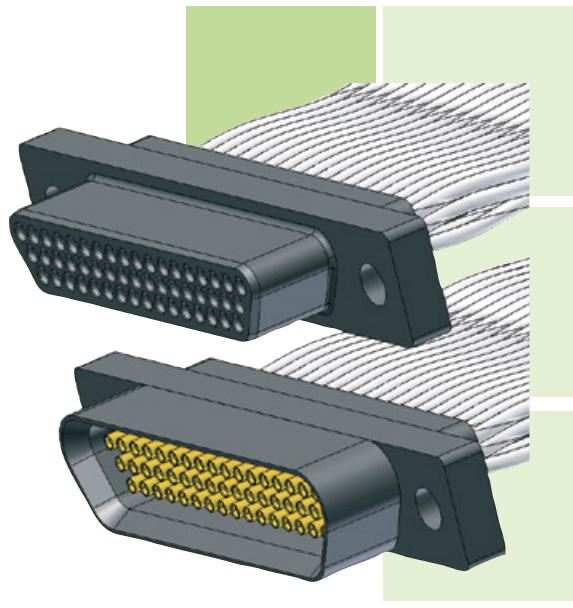

RECTANGULAR CONNECTORS

PIGTAIL CONNECTOR

PLASTIC SHELL

- Low cost plastic connector.
- Operating temperature: 150°C or 200°C.
- 9 to 51 contacts.

IDENTIFICATION CODE



SERIES

MDA: Micro-D AXON' standard series.

CONNECTOR TYPE

- P:** LCP shell + potting 150°C.
- L:** LCP shell + potting 200°C.

NUMBER OF CONTACTS 09, 15, 21, 25, 31, 37, 51.
See pages 26 & 27 for contact arrangements.

CONNECTOR GENDER

- P:** Male (pin contacts).
- S:** Female (socket contacts).

WIRE TYPE

- For colour codes **F, L, W**
- 1:** E 2607, AWG 26, 7 strands, 600V.
 - 4:** E 2619, AWG 26, 19 strands, 600V.
 - 6:** E 2807, AWG 28, 7 strands, 600V.
 - 8:** E 3007, AWG 30, 7 strands, 600V.
 - A:** E 2407, AWG 24, 7 strands, 600V.
 - C:** E 2419, AWG 24, 19 strands, 600V.
 - E:** M22759/33, AWG 26, 19 strands, 600V.
- For colour code **V** only
- 3:** M22759/11, AWG26, 19 strands, 600V.
- F:** E2607, AWG26, 7 strands, 600V.
- Solid uninsulated wires**
- G:** AWG 25 gold plated.
 - T:** AWG 24 tin plated.
- See page 29 for wire types.*

COLOUR CODE

- F:** All yellow.
 - L:** All white.
 - BLANK:** If wire type is G or T.
 - W:** 10 colour repeat.
 - V:** MIL-STD-681 striped (only for wire types 3 and F).
- See page 30 for colour code.*

WIRE LENGTH (in cm)

Attention! wire length in centimetres - (1cm = 10mm = 0.394").

L	L ≤ 10	10 < L ≤ 100	L > 100
in cm (inches)	L ≤ 3.940	3.940 < L ≤ 39.40	L > 39.40
TOLERANCE	-0 / +0.5	-0 / +3	-0 / +5
in cm (inches)	-0 / +0.200	-0 / +1.180	-0 / +1.970

HARDWARE

- B:** No hardware.
 - C:** U-clips with low profile hex socket head jackscrews (removable).
 - D:** U-clips with low profile slot head jackscrews (removable).
 - M:** Low profile hex socket head jackscrews (removable).
 - N:** High profile hex socket head jackscrews (removable).
 - S:** Low profile slot head jackscrews (removable).
 - T:** High profile slot head jackscrews (removable).
 - P:** Jackposts (removable).
 - Px** (x: 1 to 5): Panel mount jackposts.
 - K:** High profile slot head jackscrews (non removable).
 - L:** Low profile hex socket head jackscrews (non removable).
 - F:** Float mount, front panel mount (non removable).
 - FR:** Float mount, rear panel mount (non removable).
- See pages 190 to 200 for hardware description.*

DIMENSIONS

Dimensions are in millimetres (inches).

MALE connector

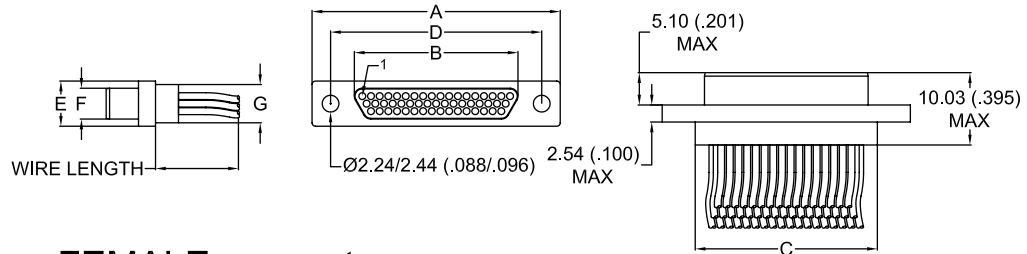

FEMALE connector

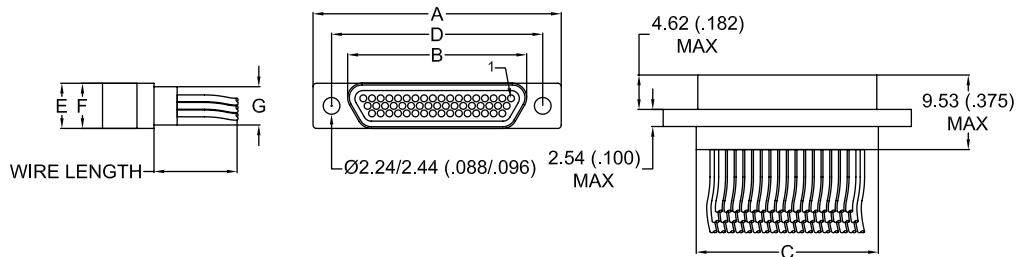

	A ± 0.25 (±.010)	B max.		C -0.46/+0.25 (-.018/+.010)	D ± 0.13 (±.005)	E ± 0.25 (±.010)	F max.		G max.
		Male	Female				Male	Female	
9 P / 9 S	19.76 .778	7.41 .292	9.65 .380	10.11 .398	14.35 .565	5.28 .208	3.40 .134	5.53 .218	4.39 .173
15 P / 15 S	23.57 .928	11.22 .442	13.46 .530	13.92 .548	18.16 .715	5.28 .208	3.40 .134	5.53 .218	4.39 .173
21 P / 21 S	27.38 1.078	15.03 .592	17.27 .680	17.73 .698	21.97 .865	5.28 .208	3.40 .134	5.53 .218	4.39 .173
25 P / 25 S	29.92 1.178	17.57 .692	19.81 .780	20.27 .798	24.51 .965	5.28 .208	3.40 .134	5.53 .218	4.39 .173
31 P / 31 S	33.73 1.328	21.38 .842	23.62 .930	24.08 .948	28.32 1.115	5.28 .208	3.40 .134	5.53 .218	4.39 .173
37 P / 37 S	37.54 1.478	25.19 .992	27.43 1.080	27.89 1.098	32.13 1.265	5.28 .208	3.40 .134	5.53 .218	4.39 .173
51 P / 51 S	36.27 1.428	23.92 .942	26.16 1.030	26.62 1.048	30.86 1.215	6.35 .250	4.50 .177	6.60 .260	5.59 .220

SUMMARY OF CHARACTERISTICS

ELECTRICAL & MECHANICAL PERFORMANCE	
CURRENT RATING	3 A max.
CONTACT RESISTANCE	8 mΩ max.
INSULATION RESISTANCE	5000 MΩ min. @ 500 Vdc
DIELECTRIC WITHSTANDING VOLTAGE	Sea level: 600 V _{AC} Altitude 21 km (70,000 ft): 150 V _{AC}
CONTACT ENGAGING FORCE	170 g max. (6 oz)
CONTACT SEPARATING FORCE	14 g min. (0.5 oz)
CONTACT RETENTION	2.26 kg (5 lbs)
DURABILITY	500 mating cycles min.
VIBRATION	20g's – No discontinuity > 1 μs
SHOCK	50g's – No discontinuity > 1 μs

MATERIAL & FINISH	
MOULDED SHELL	Liquid Crystal Polymer (LCP)
PIN CONTACT	Copper and beryllium copper, gold over nickel plating
SOCKET CONTACT	Copper Alloy, gold over nickel plating
ENCAPSULANT	Epoxy resin
HARDWARE	300 series stainless steel, passivated

SEE PAGE 24 FOR MORE INFORMATION

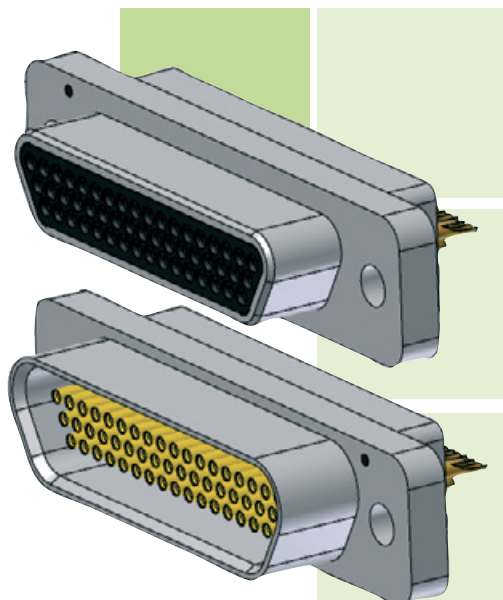

RECTANGULAR CONNECTORS

SOLDER CUP CONNECTOR

METAL SHELL

- High performance metal connector and solder cup contacts.
- Environmentally sealed.
- Ideal for prototyping or where pigtail type connectors cannot be used.
- Operating temperature: 150°C or 200°C.
- 9 to 100 contacts.

IDENTIFICATION CODE

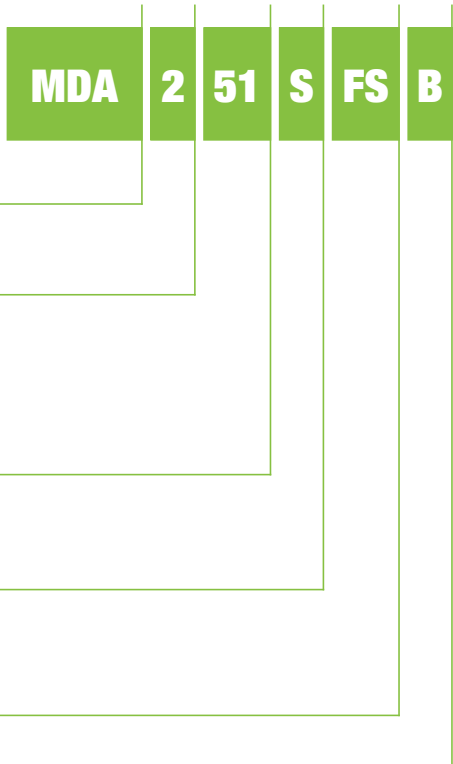

SERIES

MDA: Micro-D AXON' standard series.

CONNECTOR TYPE

- 1:** Cadmium al. shell / **Z:** Black zinc nickel aluminium shell + potting 150°C.
2: Nickel aluminium shell + potting 150°C.
3: Nickel aluminium shell + potting 200°C.
S: Passivated stainless steel shell + potting 200°C.

NUMBER OF CONTACTS

09, 15, 21, 25, 31, 37, 51DR, 51, 69, 100.
See pages 26 & 27 for contact arrangements.

CONNECTOR GENDER

- P:** Male (pin contacts).
S: Female (socket contacts).

SOLDER CUP

HARDWARE

- B:** No hardware.
C: U-clips with low profile hex socket head jackscrews (removable).
D: U-clips with low profile slot head jackscrews (removable).
M: Low profile hex socket head jackscrews (removable).
N: High profile hex socket head jackscrews (removable).
S: Low profile slot head jackscrews (removable).
T: High profile slot head jackscrews (removable).
P: Jackposts (removable).
Px (x: 1 to 5): Panel mount jackposts.
K: High profile slot head jackscrews (non removable).
L: Low profile hex socket head jackscrews (non removable).
F: Float mount, front panel mount (non removable).
FR: Float mount, rear panel mount (non removable).
See pages 190 to 200 for hardware description.

METAL CONNECTORS ARE SUPPLIED WITH ANTI-STATIC PROTECTIVE DUST CAPS

DIMENSIONS

Dimensions are in millimetres (inches).

MALE connector

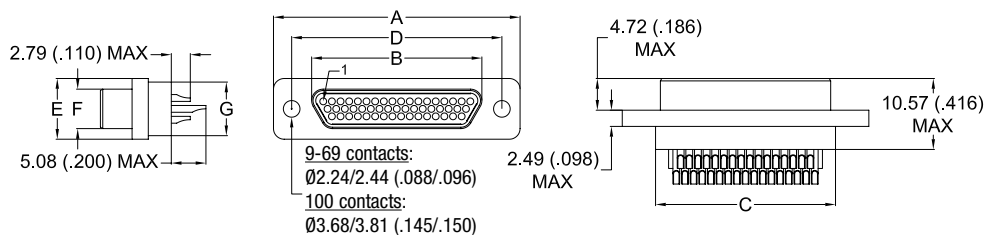

FEMALE connector

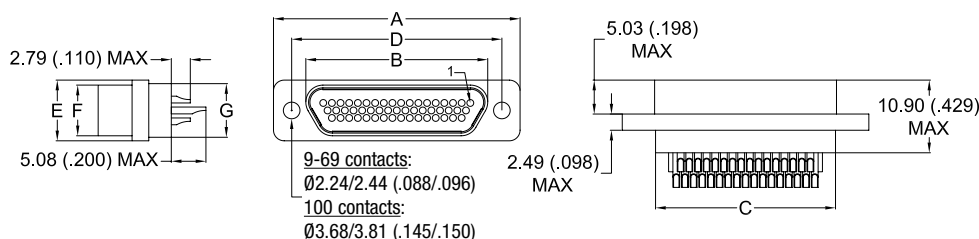

	A ± 0.25 (±.010)	B max.		C -0.46/+0.25 (-.018/+.010)	D ± 0.13 (±.005)	E ± 0.25 (±.010)	F max.		G max.
		Male	Female				Male	Female	
9 P / 9 S	19.69 .775	8.48 .334	10.16 .400	9.91 .390	14.35 .565	7.57 .298	4.69 .185	6.35 .250	6.86 .270
15 P / 15 S	23.50 .925	12.29 .484	14.00 .551	13.72 .540	18.16 .715	7.57 .298	4.69 .185	6.35 .250	6.86 .270
21 P / 21 S	27.31 1.075	16.10 .634	17.81 .701	17.53 .690	21.97 .865	7.57 .298	4.69 .185	6.35 .250	6.86 .270
25 P / 25 S	29.85 1.175	18.64 .734	20.35 .801	20.07 .790	24.51 .965	7.57 .298	4.69 .185	6.35 .250	6.86 .270
31 P / 31 S	33.66 1.325	22.45 .884	24.16 .951	23.88 .940	28.32 1.115	7.57 .298	4.69 .185	6.35 .250	6.86 .270
37 P / 37 S	37.47 1.475	26.26 1.034	27.96 1.101	27.69 1.090	32.13 1.265	7.57 .298	4.69 .185	6.35 .250	6.86 .270
51DR P / 51DR S	46.36 1.825	35.15 1.384	36.83 1.450	36.58 1.440	41.02 1.615	7.57 .298	4.69 .185	6.35 .250	6.86 .270
51 P / 51 S	36.20 1.425	24.99 .984	26.70 1.051	26.42 1.040	30.86 1.215	8.66 .341	5.79 .228	7.44 .293	7.87 .310
69 P / 69 S	43.82 1.725	32.61 1.284	34.29 1.350	34.04 1.340	38.48 1.515	8.66 .341	5.79 .228	7.44 .293	7.87 .310
100 P / 100 S	54.86 2.160	35.15 1.384	36.86 1.451	36.37 1.432	45.72 1.800	9.75 .384	6.88 .271	8.46 .333	9.14 .360

SUMMARY OF CHARACTERISTICS

ELECTRICAL & MECHANICAL PERFORMANCE	
CURRENT RATING	3 A max.
CONTACT RESISTANCE	8 mΩ max.
INSULATION RESISTANCE	5000 MΩ min. @ 500 V _{DC}
DIELECTRIC WITHSTANDING VOLTAGE	Sea level: 600 V _{AC} Altitude 21 km (70,000 ft): 150 V _{AC}
CONTACT ENGAGING FORCE	170 g max. (6 oz)
CONTACT SEPARATING FORCE	14 g min. (0.5 oz)
CONTACT RETENTION	2.26 kg (5 lbs)
DURABILITY	500 mating cycles min.
VIBRATION	20g's - No discontinuity > 1 μs
SHOCK	50g's - No discontinuity > 1 μs

MATERIAL & FINISH	
SHELL	Aluminium Alloy 6061 or 300 series stainless steel, see ordering info for plating options
MOULDED INSULATOR	Liquid Crystal Polymer (LCP)
INTERFACIAL SEAL	Fluorosilicone rubber
PIN CONTACT	Copper and beryllium copper, gold over nickel plating
SOCKET CONTACT	Copper alloy, gold over nickel plating
SOLDER CUP	Copper alloy, gold over nickel plating
ENCAPSULANT	Epoxy resin
HARDWARE	300 series stainless steel, passivated

SEE PAGE 24 FOR MORE INFORMATION

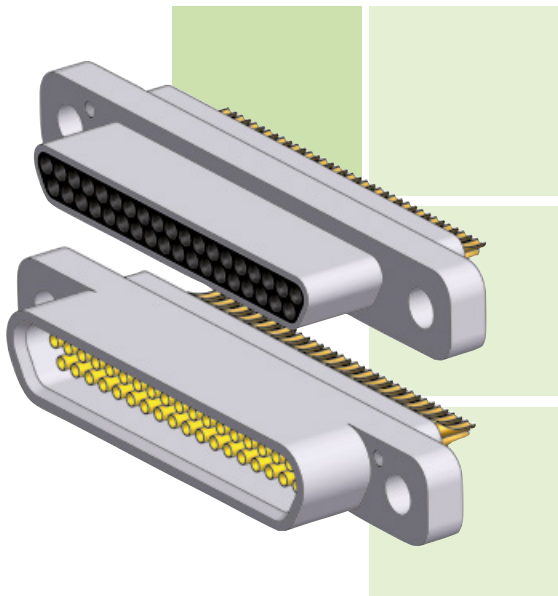

RECTANGULAR CONNECTORS

SOLDER CUP CONNECTOR

LOW PROFILE METAL SHELL

- High performance metal connector and solder cup contacts.
- Ideal for prototyping or when pigtail type connectors cannot be used.
- Operating temperature: 150°C or 200°C.
- 9 to 51 contacts.

IDENTIFICATION CODE



SERIES

MDA: Micro-D AXON' standard series.

CONNECTOR TYPE

- 1:** Cadmium al. shell / **Z:** Black zinc nickel aluminium shell + potting 150°C.
- 2:** Nickel aluminium shell + potting 150°C.
- 3:** Nickel aluminium shell + potting 200°C.
- S:** Passivated stainless steel shell + potting 200°C.

NUMBER OF CONTACTS

L09, L15, L21, L25, L31, L37, L51.
See pages 26 & 27 for contact arrangements.

CONNECTOR GENDER

- P:** Male (pin contacts).
- S:** Female (socket contacts).

SOLDER CUP

HARDWARE

- B:** No hardware.
 - C:** U-clips with low profile hex socket head jackscrews (removable).
 - D:** U-clips with low profile slot head jackscrews (removable).
 - M:** Low profile hex socket head jackscrews (removable).
 - N:** High profile hex socket head jackscrews (removable).
 - S:** Low profile slot head jackscrews (removable).
 - T:** High profile slot head jackscrews (removable).
 - P:** Jackposts (removable).
 - Px** (x: 1 to 5): Panel mount jackposts.
 - K:** High profile slot head jackscrews (non removable).
 - L:** Low profile hex socket head jackscrews (non removable).
 - F:** Float mount, front panel mount (non removable).
 - FR:** Float mount, rear panel mount (non removable).
- See pages 190 to 200 for hardware description.*

DIMENSIONS

Dimensions are in millimetres (inches).

MALE connector

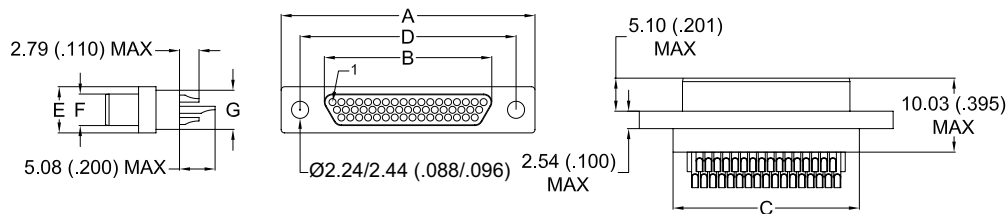

FEMALE connector

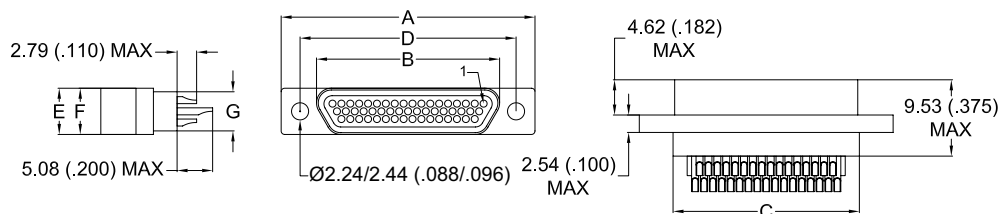

	A ± 0.25 (±.010)	B max.		C -0.46/+0.25 (-.018/+0.010)	D ± 0.13 (±.005)	E ± 0.25 (±.010)	F max.		G max.
		Male	Female				Male	Female	
9 P / 9 S	19.76 .778	7.47 .294	9.65 .380	10.11 .398	14.35 .565	5.28 .208	3.40 .134	5.53 .218	4.39 .173
15 P / 15 S	23.57 .928	11.28 .444	13.46 .530	13.92 .548	18.16 .715	5.28 .208	3.40 .134	5.53 .218	4.39 .173
21 P / 21 S	27.38 1.078	15.09 .594	17.27 .680	17.73 .698	21.97 .865	5.28 .208	3.40 .134	5.53 .218	4.39 .173
25 P / 25 S	29.92 1.178	17.63 .694	19.81 .780	20.27 .798	24.51 .965	5.28 .208	3.40 .134	5.53 .218	4.39 .173
31 P / 31 S	33.73 1.328	21.44 .844	23.62 .930	24.08 .948	28.32 1.115	5.28 .208	3.40 .134	5.53 .218	4.39 .173
37 P / 37 S	37.54 1.478	25.25 .994	27.43 1.080	27.89 1.098	32.13 1.265	5.28 .208	3.40 .134	5.53 .218	4.39 .173
51 P / 51 S	36.27 1.428	23.98 .944	26.16 1.030	26.62 1.048	30.86 1.215	6.35 .250	4.50 .177	6.60 .260	5.59 .220

SUMMARY OF CHARACTERISTICS

ELECTRICAL & MECHANICAL PERFORMANCE	
CURRENT RATING	3 A max.
CONTACT RESISTANCE	8 mΩ max.
INSULATION RESISTANCE	5000 MΩ min. @ 500 Vdc
DIELECTRIC WITHSTANDING VOLTAGE	Sea level: 600 Vac
	Altitude 21 km (70,000 ft): 150 Vac
CONTACT ENGAGING FORCE	170 g max. (6 oz)
CONTACT SEPARATING FORCE	14 g min. (0.5 oz)
CONTACT RETENTION	2,26 kg (5 lbs)
DURABILITY	500 mating cycles min.
VIBRATION	20g's - No discontinuity > 1µs
SHOCK	50g's - No discontinuity > 1µs

MATERIAL & FINISH	
MOULDED SHELL	Liquid Crystal Polymer (LCP)
PIN CONTACT	Copper and beryllium copper, gold over nickel plating
SOCKET CONTACT	Copper alloy, gold over nickel plating
SOLDER CUP	Copper alloy, gold over nickel plating
ENCAPSULENT	Epoxy resin
HARDWARE	300 series stainless steel, passivated

SEE PAGE 24 FOR MORE INFORMATION

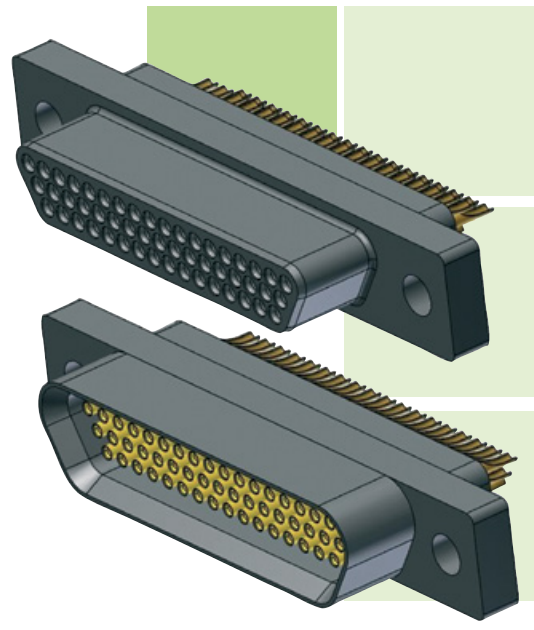

RECTANGULAR CONNECTORS

SOLDER CUP CONNECTOR

PLASTIC SHELL

- Low cost plastic connector and solder cup contacts.
- Ideal for prototyping or where pigtail type connectors cannot be used.
- Operating temperature: 150°C or 200°C.
- 9 to 51 contacts.

IDENTIFICATION CODE



SERIES

MDA: Micro-D AXON' standard series.

CONNECTOR TYPE

- P:** LCP shell + potting 150°C.
- L:** LCP shell + potting 200°C.

NUMBER OF CONTACTS

09, 15, 21, 25, 31, 37, 51.
See pages 26 & 27 for contact arrangements.

CONNECTOR GENDER

- P:** Male (pin contacts).
- S:** Female (socket contacts).

SOLDER CUP

HARDWARE

- B:** No hardware.
 - C:** U-clips with low profile hex socket head jackscrews (removable).
 - D:** U-clips with low profile slot head jackscrews (removable).
 - M:** Low profile hex socket head jackscrews (removable).
 - N:** High profile hex socket head jackscrews (removable).
 - S:** Low profile slot head jackscrews (removable).
 - T:** High profile slot head jackscrews (removable).
 - P:** Jackposts (removable).
 - Px** (x: 1 to 5): Panel mount jackposts.
 - K:** High profile slot head jackscrews (non removable).
 - L:** Low profile hex socket head jackscrews (non removable).
 - F:** Float mount, front panel mount (non removable).
 - FR:** Float mount, rear panel mount (non removable).
- See pages 190 to 200 for hardware description.*

DIMENSIONS

Dimensions are in millimetres (inches).

MALE connector

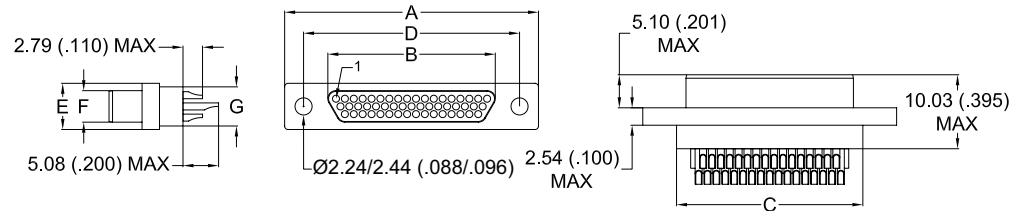

FEMALE connector

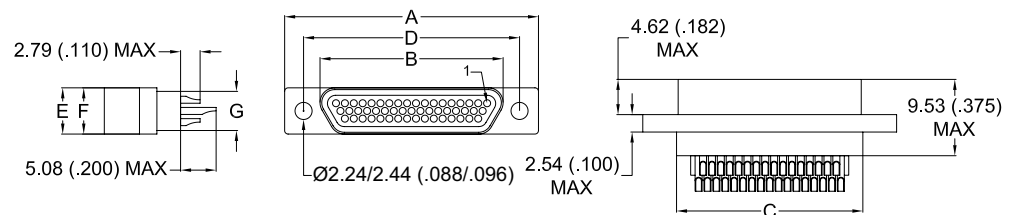

	A ± 0.25 (±.010)	B max.		C -0.46/+0.25 (-.018/+ .010)	D ± 0.13 (±.005)	E ± 0.25 (±.010)	F max.		G max.
		Male	Female				Male	Female	
9 P / 9 S	19.76 .778	7.41 .292	9.65 .380	10.11 .398	14.35 .565	5.28 .208	3.40 .134	5.53 .218	4.39 .173
15 P / 15 S	23.57 .928	11.22 .442	13.46 .530	13.92 .548	18.16 .715	5.28 .208	3.40 .134	5.53 .218	4.39 .173
21 P / 21 S	27.38 1.078	15.03 .592	17.27 .680	17.73 .698	21.97 .865	5.28 .208	3.40 .134	5.53 .218	4.39 .173
25 P / 25 S	29.92 1.178	17.57 .692	19.81 .780	20.27 .798	24.51 .965	5.28 .208	3.40 .134	5.53 .218	4.39 .173
31 P / 31 S	33.73 1.328	21.38 .842	23.62 .930	24.08 .948	28.32 1.115	5.28 .208	3.40 .134	5.53 .218	4.39 .173
37 P / 37 S	37.54 1.478	25.19 .992	27.43 1.080	27.89 1.098	32.13 1.265	5.28 .208	3.40 .134	5.53 .218	4.39 .173
51 P / 51 S	36.27 1.428	23.92 .942	26.16 1.030	26.62 1.048	30.86 1.215	6.35 .250	4.50 .177	6.60 .260	5.59 .220

SUMMARY OF CHARACTERISTICS

ELECTRICAL & MECHANICAL PERFORMANCE	
CURRENT RATING	3 A max.
CONTACT RESISTANCE	8 mΩ max.
INSULATION RESISTANCE	5000 MΩ min. @ 500 Vdc
DIELECTRIC WITHSTANDING VOLTAGE	Sea level: 600 Vac Altitude 21 km (70,000 ft): 150 Vac
CONTACT ENGAGING FORCE	170 g max. (6 oz)
CONTACT SEPARATING FORCE	14 g min. (0.5 oz)
CONTACT RETENTION	2.26 kg (5 lbs)
DURABILITY	500 mating cycles min.
VIBRATION	20g's – No discontinuity > 1 μs
SHOCK	50g's – No discontinuity > 1 μs

MATERIAL & FINISH	
MOULDED SHELL	Liquid Crystal Polymer (LCP)
PIN CONTACT	Copper and beryllium copper, gold over nickel plating
SOCKET CONTACT	Copper alloy, gold over nickel plating
SOLDER CUP	Copper alloy, gold over nickel plating
ENCAPSULANT	Epoxy resin
HARDWARE	300 series stainless steel, passivated

SEE PAGE 24 FOR MORE INFORMATION

Micro-D connectors

PCB CONNECTORS OVERVIEW

AXON' Micro-D Printed Circuit Board connectors are designed for interconnection of PCB's inside-the-box to external cables.

AXON' Micro-D PCB connectors are available in two layouts (0.100" pitch and 0.075" pitch) and in two configurations (vertical mount and right angle mount connector) for flexible and rigid printed circuit boards.

NOTE: typically, the PCB connector tends to be female, however male versions are equally available.

PCB CONNECTORS 0.100" PITCH

BS 0.100" Vertical mount

Available from 9 to 100 ways
Available in metal and plastic shell
PCB code: **BS**

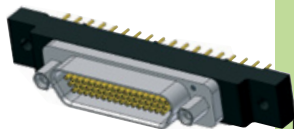
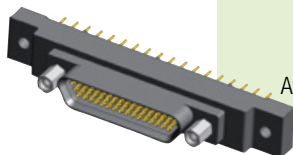

Pages 98 & 100

BR 0.100" Right Angle mount

Available from 9 to 100 ways
Available in metal shell
PCB code: **BR**

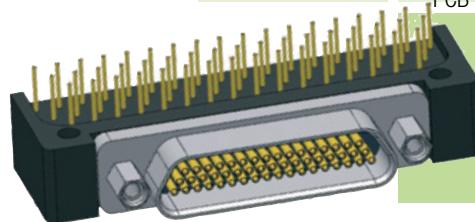

Page 92

CBR 0.100" Condensed Right Angle mount

Available from 9 to 100 ways
Available in metal and plastic shell
PCB code: **CBR**

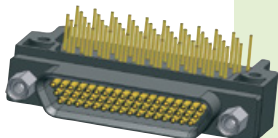

Pages 78 & 80

CBP 0.100" Condensed Right Angle mount low profile

Available from 9 to 51 ways
Available in metal and plastic shell
PCB code: **CBP**

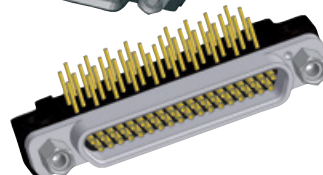
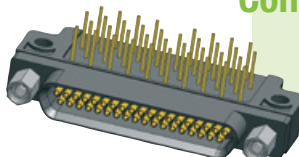

Pages 86 & 88

PCB CONNECTORS 0.075" PITCH

BS 0.075" Vertical mount

Available from 9 to 100 ways
Available in metal and plastic shell
PCB code: **75SA / 75SB**

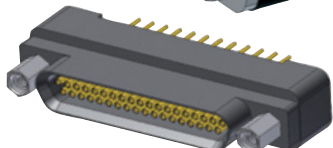
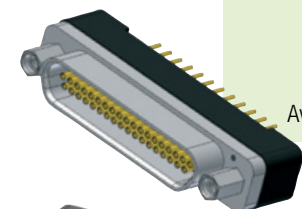

Pages 116 & 118

CBR 0.075" Condensed Right Angle mount

Available from 9 to 100 ways
Available in metal shell
PCB code: **75RB / 75RC**

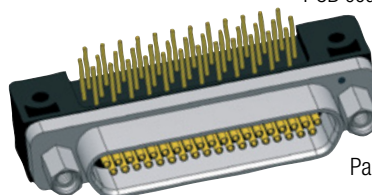

Pages 106 & 112

PCB CONNECTOR VERSIONS

Differences in length and width

Example of the 51 way connectors

The main advantage of the Micro-D PCB connectors with a pitch of 0.075 inch in comparison to the 0.1 inch version is to save space on the PCB layout.

VERTICAL CONNECTOR

The 0.075" BS version has more or less the same width as the 0.100" BS version but is shorter in length.

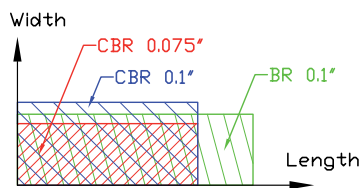
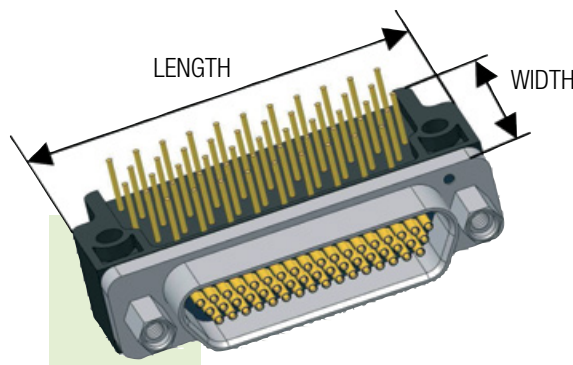
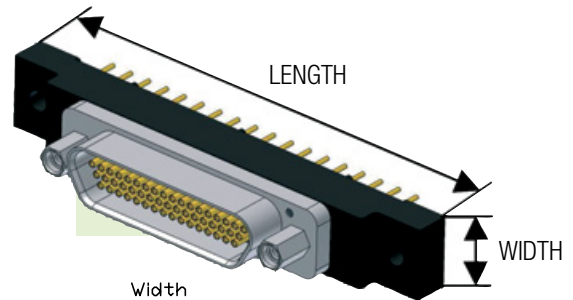

RIGHT ANGLE CONNECTOR

The 0.100" CBR connector is a little wider, but substantially shorter than the 0.100" BR connector.

The 0.075" CBR connector is more or less the same length as the 0.100" CBR version, but is narrower in width in comparison to both the CBR and even the BR connectors in the 0.100" format.

SUMMARY OF CHARACTERISTICS

ELECTRICAL & MECHANICAL PERFORMANCE	
CURRENT RATING	3 A max.
CONTACT RESISTANCE	8 mΩ max.
INSULATION RESISTANCE	5000 MΩ min. @ 500 V _{DC}
DIELECTRIC WITHSTANDING VOLTAGE	Sea Level: 600 V _{AC} Altitude 21 km (70,000 ft): 150 V _{AC}
CONTACT ENGAGING FORCE	170 g max. (6 oz)
CONTACT SEPARATING FORCE	14 g min. (0.5 oz)
CONTACT RETENTION	2.26 kg (5 lbs)
DURABILITY	500 mating cycles min.
VIBRATION	20g's – No discontinuity > 1 μs
SHOCK	50g's – No discontinuity > 1 μs

MATERIAL & FINISH	
SHELL	Aluminium alloy 6061, 300 series stainless steel or LCP, see ordering info for plating options
MOULDED INSULATOR	Liquid Crystal Polymer (LCP)
INTERFACIAL SEAL	Fluorosilicone rubber (metal version)
PIN CONTACT	Copper and beryllium copper, gold over nickel plating
SOCKET CONTACT	Copper alloy, gold over nickel plating
ENCAPSULANT	Epoxy resin
MOULDED TRAY	Liquid Crystal Polymer (LCP)
PCB TERMINALS	See ordering info for PCB terminals material
HARDWARE	300 series stainless steel, passivated

SEE PAGE 24 FOR MORE INFORMATION

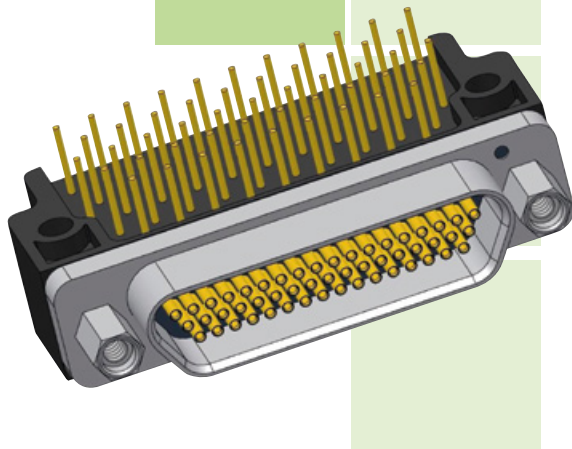

PCB RECTANGULAR CONNECTORS

CBR TYPE 0.100" PITCH

METAL SHELL

- Condensed board right angle connector for flexible and rigid printed circuit boards.
- Operating temperature: 150°C or 200°C.
- Several tail lengths available.

IDENTIFICATION CODE

MDA 2 51 S CBR P G 3

SERIES

MDA: Micro-D AXON' standard series.

CONNECTOR TYPE

1: Cadmium al. shell / **Z:** Black zinc nickel aluminium shell + potting 150°C.

2: Nickel aluminium shell + potting 150°C.

3: Nickel aluminium shell + potting 200°C.

S: Passivated stainless steel shell + potting 200°C.

NUMBER OF CONTACTS

09, 15, 21, 25, 31, 37, 51DR, 51, 69, 100.

See pages 26 & 27 for contact arrangements.

CONNECTOR GENDER

P: Male (pin contacts).

S: Female (socket contacts).

PCB VERSION

CBR: 0.100" Condensed Board Right Angle.

HARDWARE

B: No hardware.

P: Jackposts.

Px (x: 1 to 5): Panel mount jackposts.

T: Threaded inserts installed.

W: Jackposts and threaded inserts installed.

Wx (x: 1 to 5): Panel mount jackposts and threaded inserts installed.

See pages 190 to 200 for hardware description.

CONDUCTOR TYPE

G: Gold plated solid conductor AWG 25.

T: Tin plated solid conductor AWG 24.

See page 29 for conductor types.

TAIL LENGTH

1: 2.80 mm (0.110").

2: 3.80 mm (0.150").

3: 4.80 mm (0.190").

4: 6.35 mm (0.250").

5: 3.25 mm (0.127").

6: 3.56 mm (0.140").

7: 4.37 mm (0.172").

Tolerance: ± 0.38 mm (0.015").

Other lengths available on request.

METAL CONNECTORS ARE SUPPLIED WITH ANTI-STATIC PROTECTIVE DUST CAPS

DIMENSIONS

Dimensions are in millimetres (inches).

FEMALE connector

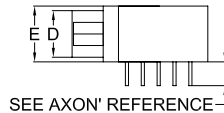
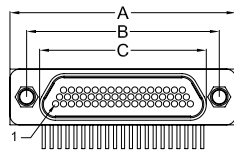

9-25 way connectors

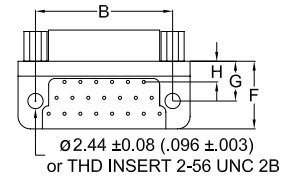

31-69 way connectors

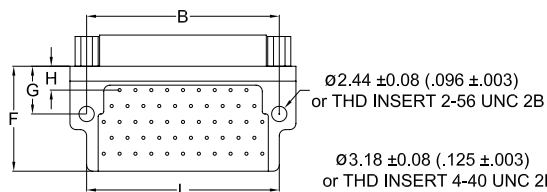

SEE CONTACT LAYOUT ON PCB PAGES 82 TO 85

100 way connectors

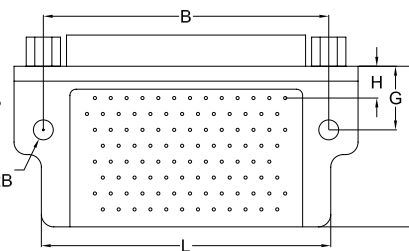

	A max.	B ± 0.13 ($\pm .005$)	C max.		D max.		E max.	F max.	G ± 0.25 ($\pm .010$)	H ± 0.25 ($\pm .010$)	L max.
			Male	Female	Male	Female					
9 P / 9 S	19.94 .785	14.35 .565	8.48 .334	10.16 .400	4.69 .185	6.35 .250	7.82 .308	10.80 .425	6.35 .250	5.84 .230	-
15 P / 15 S	23.75 .935	18.16 .715	12.29 .484	14.00 .551	4.69 .185	6.35 .250	7.82 .308	10.80 .425	6.35 .250	3.30 .130	-
21 P / 21 S	27.56 1.085	21.97 .865	16.10 .634	17.81 .701	4.69 .185	6.35 .250	7.82 .308	10.80 .425	6.35 .250	3.30 .130	-
25 P / 25 S	30.10 1.185	24.51 .965	18.64 .734	20.35 .801	4.69 .185	6.35 .250	7.82 .308	10.80 .425	6.35 .250	3.30 .130	-
31 P / 31 S	33.91 1.335	28.32 1.115	22.45 .883	24.16 .951	4.69 .185	6.35 .250	7.82 .308	13.34 .525	6.35 .250	3.30 .130	27.69 1.090
37 P / 37 S	37.72 1.485	32.13 1.265	26.26 1.034	27.96 1.101	4.69 .185	6.35 .250	7.82 .308	13.34 .525	6.35 .250	3.30 .130	30.23 1.190
51DR P / 51DR S	46.61 1.835	41.02 1.615	35.15 1.384	36.83 1.450	4.69 .185	6.35 .250	7.82 .308	13.34 .525	6.35 .250	3.30 .130	39.12 1.540
51 P / 51 S	36.45 1.435	30.86 1.215	24.99 .984	26.70 1.051	5.79 .228	7.44 .293	8.92 .351	16.76 .660	7.62 .300	3.81 .150	31.24 1.230
69 P / 69 S	44.07 1.735	38.48 1.515	32.61 1.284	34.29 1.350	5.79 .228	7.44 .293	8.92 .351	19.05 .750	7.62 .300	3.81 .150	38.86 1.530
100 P / 100 S	55.11 2.170	45.72 1.800	35.15 1.384	36.86 1.451	6.88 .271	8.46 .333	10.01 .394	25.65 1.010	10.16 .400	5.08 .200	46.36 1.825

SUMMARY OF CHARACTERISTICS

ELECTRICAL & MECHANICAL PERFORMANCE	
CURRENT RATING	3 A max.
CONTACT RESISTANCE	8 m Ω max.
INSULATION RESISTANCE	5000 M Ω min. @ 500 Vdc
DIELECTRIC WITHSTANDING VOLTAGE	Sea level: 600 Vac Altitude 21 km (70,000 ft): 150 Vac
CONTACT ENGAGING FORCE	170 g max. (6 oz)
CONTACT SEPARATING FORCE	14 g min. (0.5 oz)
CONTACT RETENTION	2.26 kg (5 lbs)
DURABILITY	500 mating cycles min.
VIBRATION	20g's - No discontinuity > 1 μ s
SHOCK	50g's - No discontinuity > 1 μ s

MATERIAL & FINISH	
SHELL	Aluminium Alloy 6061 or 300 series stainless steel, see ordering info for plating options
MOULDED INSULATOR	Liquid Crystal Polymer (LCP)
INTERFACIAL SEAL	Fluorosilicone rubber
PIN CONTACT	Copper and beryllium copper, gold over nickel plating
SOCKET CONTACT	Copper alloy, gold over nickel plating
ENCAPSULANT	Epoxy resin
MOULDED TRAY	Liquid Crystal Polymer (LCP)
PCB TERMINALS	See ordering info for PCB terminals material
HARDWARE	300 series stainless steel, passivated

SEE PAGE 24 FOR MORE INFORMATION



PCB RECTANGULAR CONNECTORS

CBR TYPE

0.100" PITCH

PLASTIC SHELL

- Condensed board right angle connector for flexible and rigid printed circuit boards.
- Operating temperature: 150°C or 200°C.
- Several tail lengths available.

IDENTIFICATION CODE



SERIES

MDA: Micro-D AXON' standard series.

CONNECTOR TYPE

P: LCP shell + potting 150°C.
L: LCP shell + potting 200°C.

NUMBER OF CONTACTS

09, 15, 21, 25, 31, 37, 51.
See pages 26 & 27 for contact arrangements.

CONNECTOR GENDER

P: Male (pin contacts).
S: Female (socket contacts).

PCB VERSION

CBR: 0.100" Condensed Board Right Angle.

HARDWARE

B: No hardware.
P: Jackposts.
Px (x: 1 to 5): Panel mount jackposts.
T: Threaded inserts installed.
W: Jackposts and threaded inserts installed.
Wx (x: 1 to 5): Panel mount jackposts and threaded inserts installed.
See pages 190 to 200 for hardware description.

CONDUCTOR TYPE

G: Gold plated solid conductor AWG 25.
T: Tin plated solid conductor AWG 24.
See page 29 for conductor types.

TAIL LENGTH

- | | |
|-----------------------------|-----------------------------|
| 1: 2.80 mm (0.110"). | 5: 3.25 mm (0.127"). |
| 2: 3.80 mm (0.150"). | 6: 3.56 mm (0.140"). |
| 3: 4.80 mm (0.190"). | 7: 4.37 mm (0.172"). |
| 4: 6.35 mm (0.250"). | |

Tolerance: ± 0.38 mm (0.015").
Other lengths available on request.

DIMENSIONS

Dimensions are in millimetres (inches).

FEMALE connector

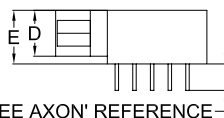
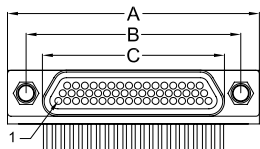

SEE AXON' REFERENCE

9-25 way connectors

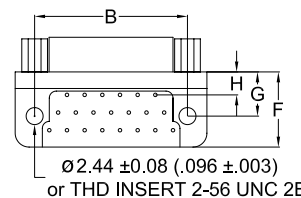

31-51 way connectors

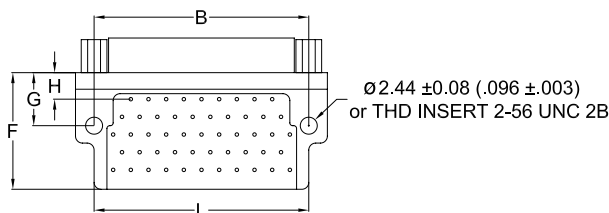

SEE CONTACT LAYOUT ON PCB PAGES 82 TO 85

	A max.	B ± 0.13 (±.005)	C max.		D max.		E max.	F max.	G ± 0.25 (±.010)	H ± 0.25 (±.010)	L max.
			Male	Female	Male	Female					
9 P / 9 S	19.94 .785	14.35 .565	7.41 .292	9.65 .380	3.40 .134	5.53 .218	6.80 .268	10.80 .425	6.35 .250	5.84 .230	-
15 P / 15 S	23.75 .935	18.16 .715	11.22 .442	13.46 .530	3.40 .134	5.53 .218	6.80 .268	10.80 .425	6.35 .250	3.30 .130	-
21 P / 21 S	27.56 1.085	21.97 .865	15.03 .592	17.27 .680	3.40 .134	5.53 .218	6.80 .268	10.80 .425	6.35 .250	3.30 .130	-
25 P / 25 S	30.10 1.185	24.51 .965	17.57 .692	19.81 .780	3.40 .134	5.53 .218	6.80 .268	10.80 .425	6.35 .250	3.30 .130	-
31 P / 31 S	33.91 1.335	28.32 1.115	21.38 .842	23.62 .930	3.40 .134	5.53 .218	6.80 .268	13.34 .525	6.35 .250	3.30 .130	27.69 1.090
37 P / 37 S	37.72 1.485	32.13 1.265	25.19 .992	27.43 1.080	3.40 .134	5.53 .218	6.80 .268	13.34 .525	6.35 .250	3.30 .130	30.23 1.190
51 P / 51 S	36.45 1.435	30.86 1.215	23.92 .942	26.16 1.030	4.50 .177	6.60 .260	7.90 .311	16.76 .660	7.62 .300	3.81 .150	31.24 1.230

SUMMARY OF CHARACTERISTICS

ELECTRICAL & MECHANICAL PERFORMANCE	
CURRENT RATING	3 A max.
CONTACT RESISTANCE	8 mΩ max.
INSULATION RESISTANCE	5000 MΩ min. @ 500 Vdc
DIELECTRIC WITHSTANDING VOLTAGE	Sea level: 600 Vac Altitude 21 km (70,000 ft): 150 Vac
CONTACT ENGAGING FORCE	170 g max. (6 oz)
CONTACT SEPARATING FORCE	14 g min. (0.5 oz)
CONTACT RETENTION	2.26 kg (5 lbs)
DURABILITY	500 mating cycles min.
VIBRATION	20g's – No discontinuity > 1 μs
SHOCK	50g's – No discontinuity > 1 μs

MATERIAL & FINISH	
MOULDED SHELL	Liquid Crystal Polymer (LCP)
PIN CONTACT	Copper and beryllium copper, gold over nickel plating
SOCKET CONTACT	Copper alloy, gold over nickel plating
ENCAPSULANT	Epoxy resin
MOULDED TRAY	Liquid Crystal Polymer (LCP)
PCB TERMINALS	See ordering info for PCB terminals material
HARDWARE	300 series stainless steel, passivated

SEE PAGE 24 FOR MORE INFORMATION

PCB LAYOUT FOR CBR TYPE 0.100" PITCH - MALE CONNECTORS

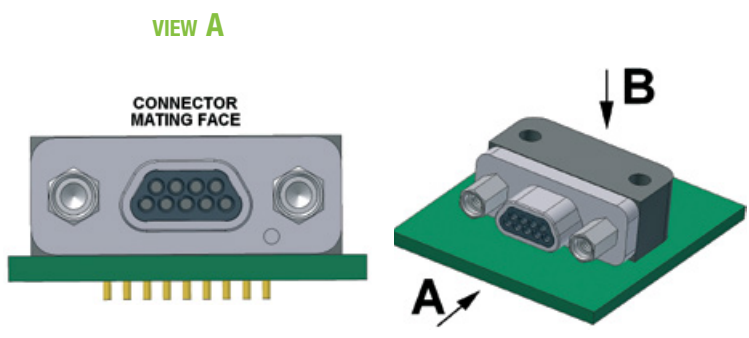

9 CONTACTS - VIEW B

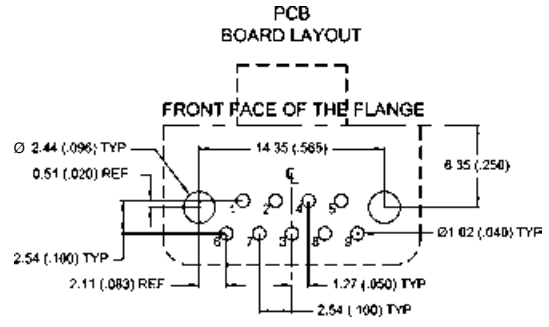

15 CONTACTS - VIEW B

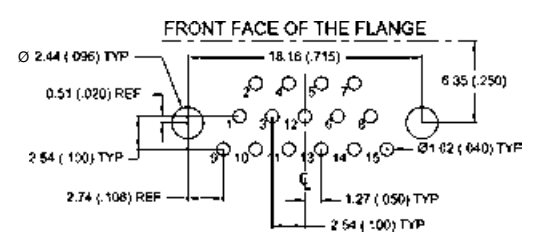

21 CONTACTS - VIEW B

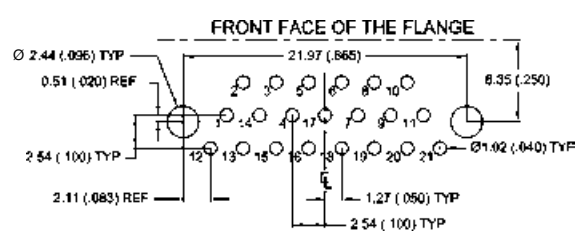

25 CONTACTS - VIEW B

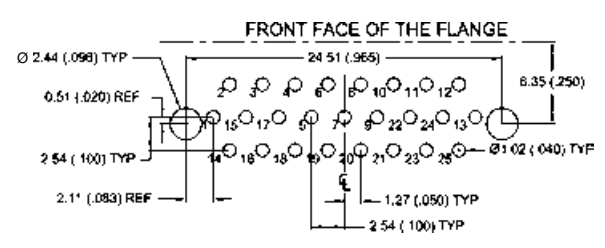

31 CONTACTS - VIEW B

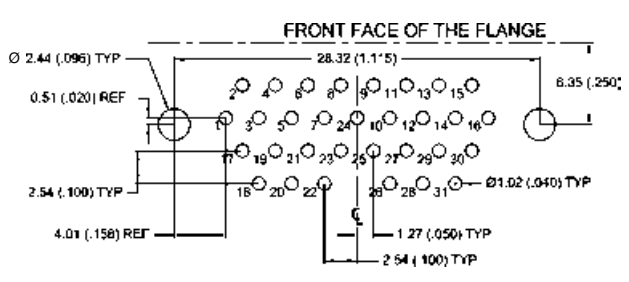

37 CONTACTS - VIEW B

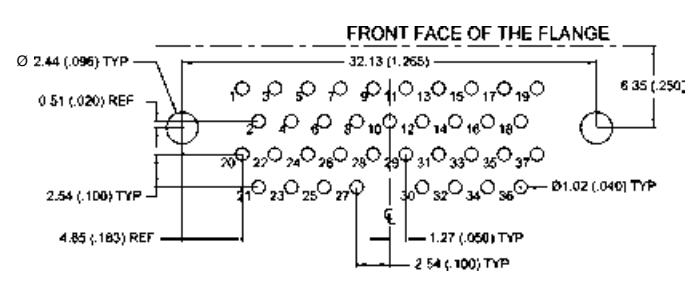

PCB LAYOUT FOR CBR TYPE 0.100" PITCH - MALE CONNECTORS

51 CONTACTS (DOUBLE ROW) - VIEW B

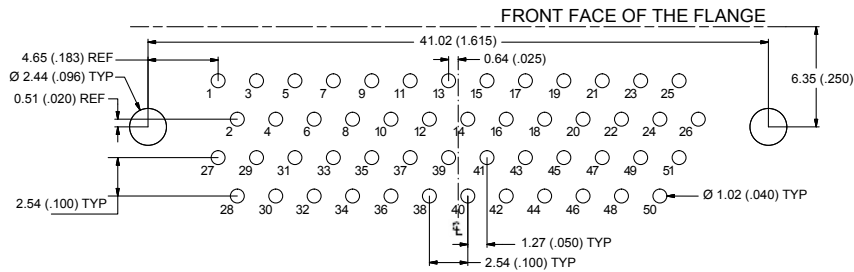

51 CONTACTS - VIEW B

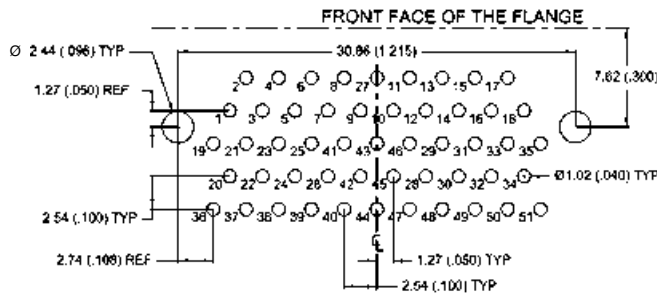

69 CONTACTS - VIEW B

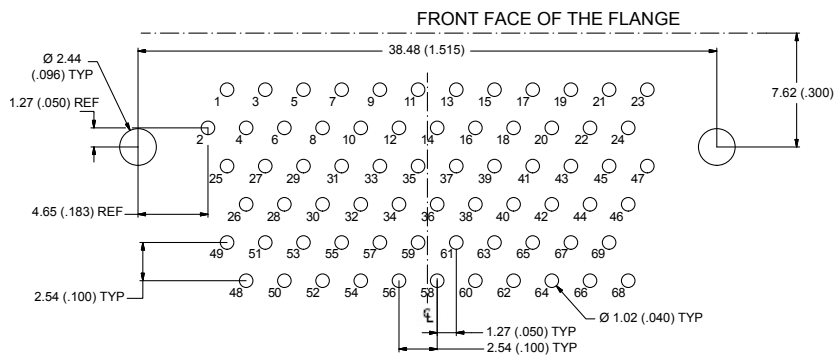

100 CONTACTS - VIEW B

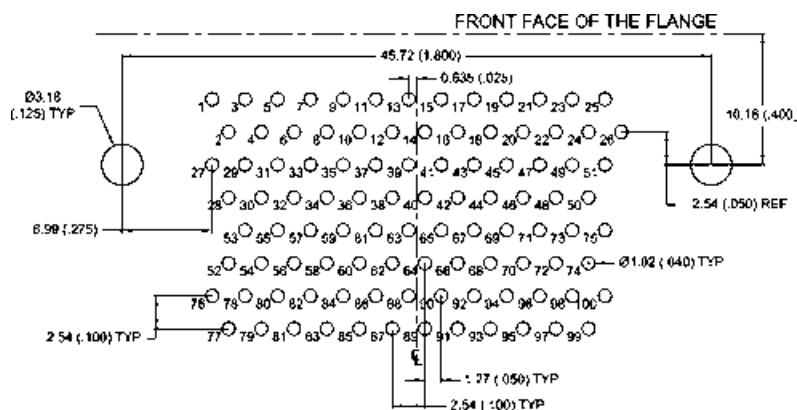

PCB LAYOUT FOR CBR TYPE 0.100" PITCH - FEMALE CONNECTORS

VIEW A

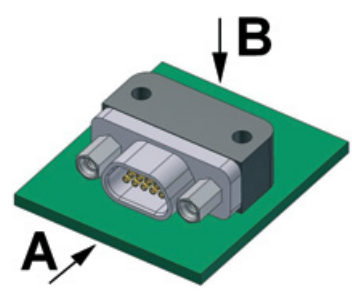
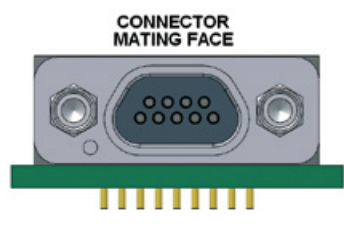

9 CONTACTS - VIEW B

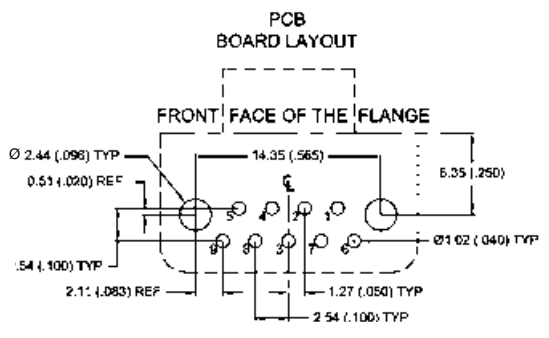

15 CONTACTS - VIEW B

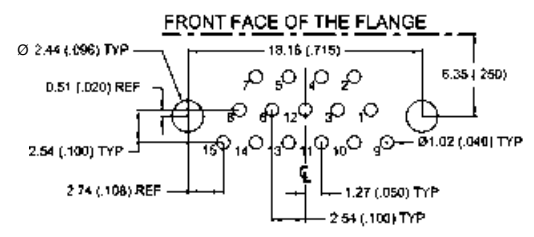

21 CONTACTS - VIEW B

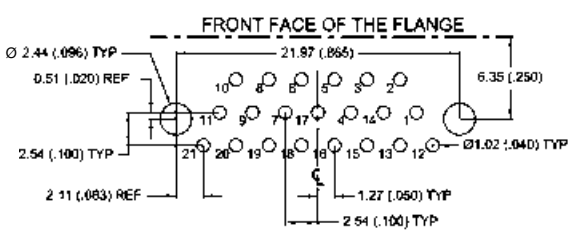

25 CONTACTS - VIEW B

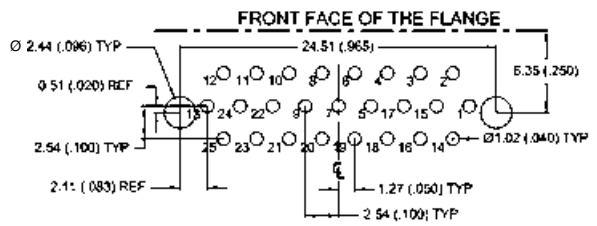

31 CONTACTS - VIEW B

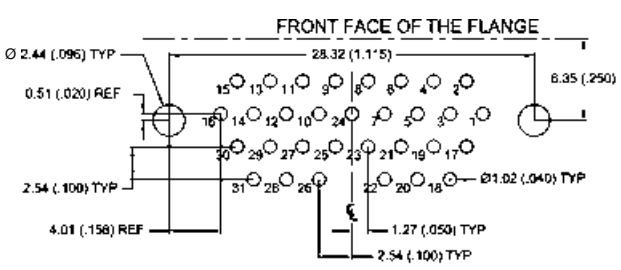

37 CONTACTS - VIEW B

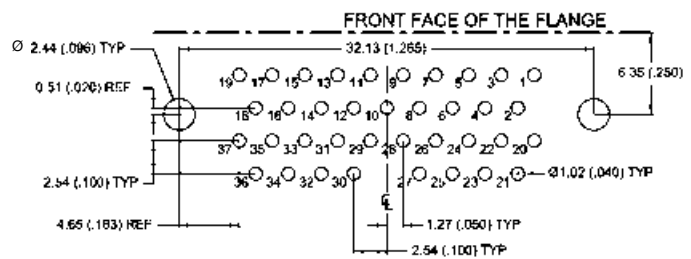

PCB LAYOUT FOR CBR TYPE 0.100" PITCH - FEMALE CONNECTORS

51 CONTACTS (DOUBLE ROW) - VIEW B

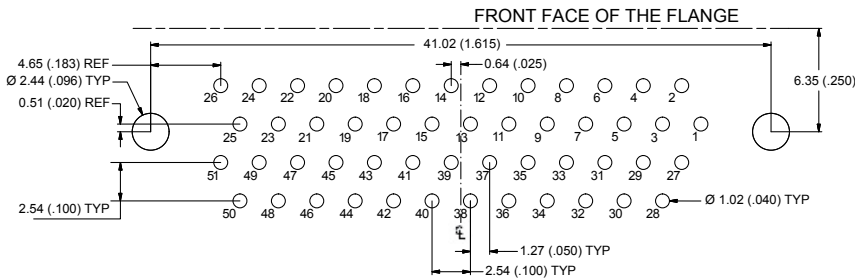

51 CONTACTS - VIEW B

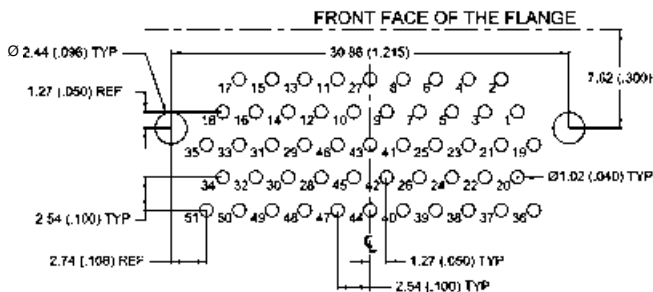

69 CONTACTS - VIEW B

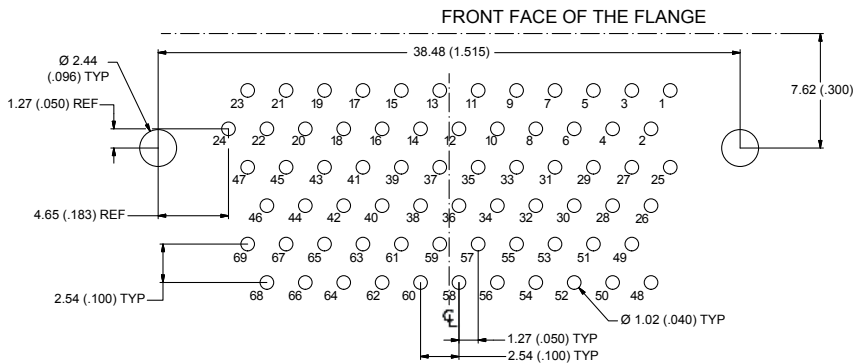

100 CONTACTS - VIEW B

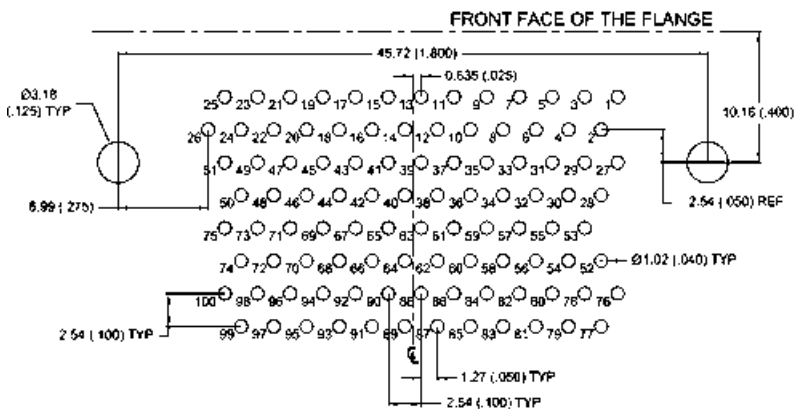

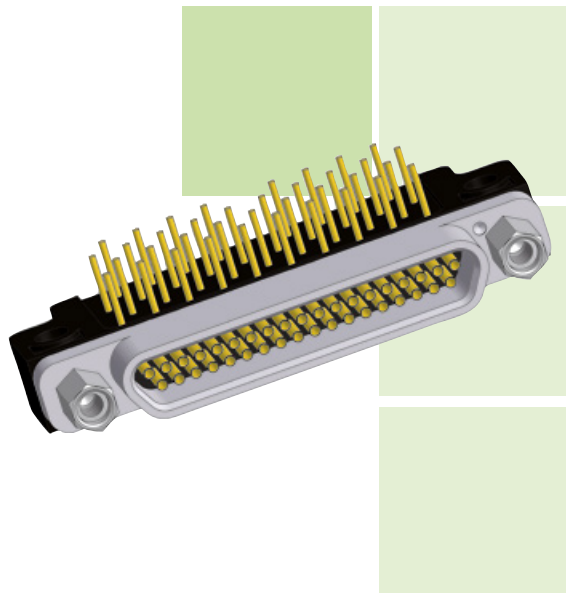

RECTANGULAR CONNECTORS

CBP TYPE LOW PROFILE CBR 0.100" PITCH

METAL SHELL

- Low profile condensed board right angle connector for flexible and rigid printed circuit boards.
- Operating temperature: 150°C or 200°C.
- Several tail lengths available.

IDENTIFICATION CODE



SERIES

MDA: Micro-D AXON' standard series.

CONNECTOR TYPE

- 1:** Cadmium al. shell / **Z:** Black zinc nickel aluminium shell + potting 150°C.
2: Nickel aluminium shell + potting 150°C.
3: Nickel aluminium shell + potting 200°C.
S: Passivated stainless steel shell + potting 200°C.

NUMBER OF CONTACTS

L09, L15, L21, L25, L31, L37, L51.
 See pages 26 & 27 for contact arrangements.

CONNECTOR GENDER

- P:** Male (pin contacts).
S: Female (socket contacts).

PCB VERSION

CBP: 0.100" Condensed Board Right Angle, low profile.

HARDWARE

- B:** No hardware.
P: Jackposts.
Px (x: 1 to 5): Panel mount jackposts.
T: Threaded inserts installed.
W: Jackposts and threaded inserts installed.
Wx (x: 1 to 5): Panel mount jackposts and threaded inserts installed.
 See pages 190 to 200 for hardware description.

CONDUCTOR TYPE

- G:** Gold plated solid conductor AWG 25.
T: Tin plated solid conductor AWG 24.
 See page 29 for conductor types.

TAIL LENGTH

- 1:** 2.80 mm (0.110").
2: 3.80 mm (0.150").
3: 4.80 mm (0.190").
4: 6.35 mm (0.250").
5: 3.25 mm (0.127").
6: 3.56 mm (0.140").
7: 4.37 mm (0.172").

Tolerance: ± 0.38 mm (0.015").
 Other lengths available on request.

DIMENSIONS

Dimensions are in millimetres (inches).

FEMALE connector

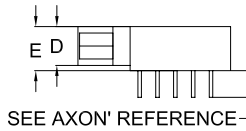
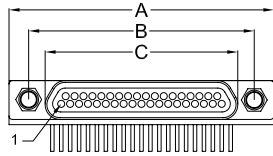

9-25 way connectors

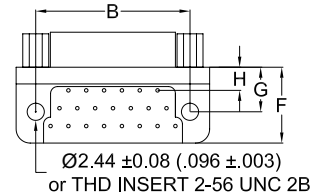

31-51 way connectors

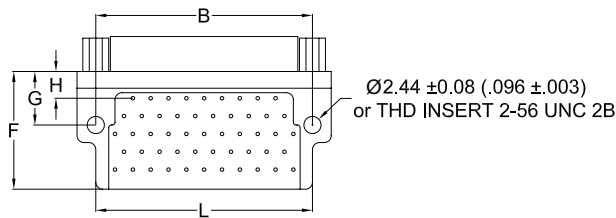

SEE CONTACT LAYOUT ON PCB PAGES 90 & 91

	A ± 0.25 (±.010)	B ± 0.13 (±.005)	C max.		D max.		E max.	F max.	G ± 0.25 (±.010)	H ± 0.25 (±.010)	L max.
			Male	Female	Male	Female					
9 P / 9 S	19.94 .785	14.35 .565	7.47 .294	9.65 .380	3.40 .134	5.53 .218	5.70 .224	10.80 .425	6.35 .250	5.84 .230	-
15 P / 15 S	23.75 .935	18.16 .715	11.28 .444	13.46 .530	3.40 .134	5.53 .218	5.70 .224	10.80 .425	6.35 .250	3.30 .130	-
21 P / 21 S	27.56 1.085	21.97 .865	15.09 .594	17.27 .680	3.40 .134	5.53 .218	5.70 .224	10.80 .425	6.35 .250	3.30 .130	-
25 P / 25 S	30.10 1.185	24.51 .965	17.63 .694	19.81 .780	3.40 .134	5.53 .218	5.70 .224	10.80 .425	6.35 .250	3.30 .130	-
31 P / 31 S	33.91 1.335	28.32 1.115	21.44 .844	23.62 .930	3.40 .134	5.53 .218	5.70 .224	13.34 .525	6.35 .250	3.30 .130	27.69 1.090
37 P / 37 S	37.72 1.485	32.13 1.265	25.25 .994	27.43 1.080	3.40 .134	5.53 .218	5.70 .224	13.34 .525	6.35 .250	3.30 .130	30.23 1.100
51 P / 51 S	36.45 1.435	30.86 1.215	23.98 .944	26.16 1.030	4.50 .177	6.60 .260	6.81 .268	16.76 .660	7.62 .300	3.81 .150	31.24 1.230

SUMMARY OF CHARACTERISTICS

ELECTRICAL & MECHANICAL PERFORMANCE	
CURRENT RATING	3 A max.
CONTACT RESISTANCE	8 mΩ max.
INSULATION RESISTANCE	5000 MΩ min. @ 500 Vdc
DIELECTRIC WITHSTANDING VOLTAGE	Sea level: 600 Vac
	Altitude 21 km (70,000 ft): 150 Vac
CONTACT ENGAGING FORCE	170 g max. (6 oz)
CONTACT SEPARATING FORCE	14 g min. (0.5 oz)
CONTACT RETENTION	2.26 kg (5 lbs)
DURABILITY	500 mating cycles min.
VIBRATION	20g's - No discontinuity > 1µs
SHOCK	50g's - No discontinuity > 1µs

MATERIAL & FINISH	
SHELL	Aluminium alloy 6061 or 300 series stainless steel, see ordering info for plating options
MOULDED INSULATOR	Liquid Crystal Polymer (LCP)
PIN CONTACT	Copper and beryllium copper, gold over nickel plating
SOCKET CONTACT	Copper alloy, gold over nickel plating
ENCAPSULENT	Epoxy resin
MOULDED TRAY	Liquid Crystal Polymer (LCP)
PCB TERMINALS	See ordering info for PCB terminals material
HARDWARE	300 series stainless steel, passivated

SEE PAGE 24 FOR MORE INFORMATION

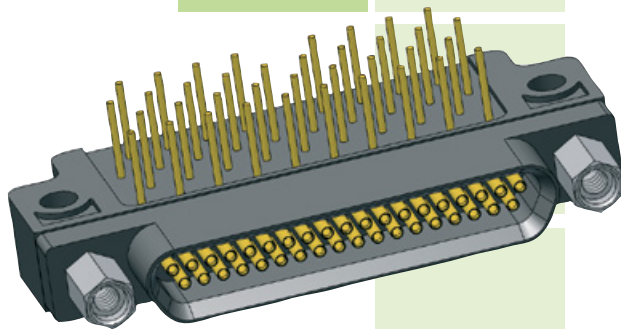

PCB RECTANGULAR CONNECTORS

CBP TYPE LOW PROFILE CBR 0.100" PITCH

PLASTIC SHELL

- Low profile condensed board right angle connector for flexible and rigid printed circuit boards.
- Operating temperature: 150°C or 200°C.
- Several tail lengths available.

IDENTIFICATION CODE



SERIES

MDA: Micro-D AXON' standard series.

CONNECTOR TYPE

P: LCP shell + potting 150°C.

L: LCP shell + potting 200°C.

NUMBER OF CONTACTS

09, 15, 21, 25, 31, 37, 51.

See pages 26 & 27 for contact arrangements.

CONNECTOR GENDER

P: Male (pin contacts).

S: Female (socket contacts).

PCB VERSION

CBP: 0.100" Condensed Board Right Angle, low profile.

HARDWARE

B: No hardware.

P: Jackposts.

Px (x: 1 to 5): Panel mount jackposts.

T: Threaded inserts installed.

W: Jackposts and threaded inserts installed.

Wx (x: 1 to 5): Panel mount jackposts and threaded inserts installed.

See pages 190 to 200 for hardware description.

CONDUCTOR TYPE

G: Gold plated solid conductor AWG 25.

T: Tin plated solid conductor AWG 24.

See page 29 for conductor types.

TAIL LENGTH

1: 2.80 mm (0.110").

2: 3.80 mm (0.150").

3: 4.80 mm (0.190").

4: 6.35 mm (0.250").

5: 3.25 mm (0.127").

6: 3.56 mm (0.140").

7: 4.37 mm (0.172").

Tolerance: ± 0.38 mm (0.015").

Other lengths available on request.

DIMENSIONS

Dimensions are in millimetres (inches).

FEMALE connector

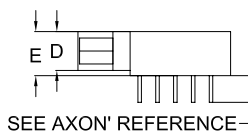
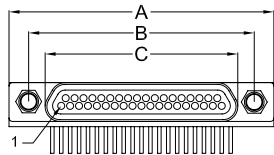

9-25 way connectors

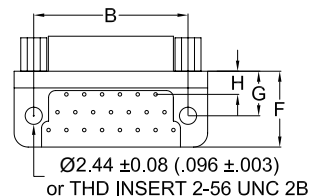

31-51 way connectors

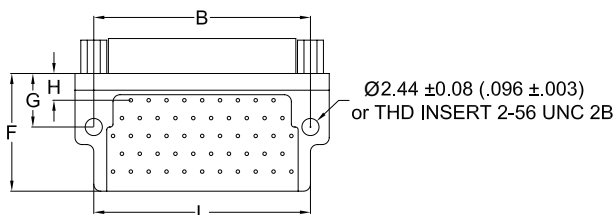

SEE CONTACT LAYOUT ON PCB PAGES 90 & 91

	A max.	B ± 0.13 (±.005)	C max.		D max.		E max.	F max.	G ± 0.25 (±.010)	H ± 0.25 (±.010)	L max.
			Male	Female	Male	Female					
9 P / 9 S	19.94 .785	14.35 .565	7.41 .292	9.65 .380	3.40 .134	5.53 .218	5.70 .224	10.80 .425	6.35 .250	5.84 .230	-
15 P / 15 S	23.75 .935	18.16 .715	11.22 .442	13.46 .530	3.40 .134	5.53 .218	5.70 .224	10.80 .425	6.35 .250	3.30 .130	-
21 P / 21 S	27.56 1.085	21.97 .865	15.03 .592	17.27 .680	3.40 .134	5.53 .218	5.70 .224	10.80 .425	6.35 .250	3.30 .130	-
25 P / 25 S	30.10 1.185	24.51 .965	17.57 .692	19.81 .780	3.40 .134	5.53 .218	5.70 .224	10.80 .425	6.35 .250	3.30 .130	-
31 P / 31 S	33.91 1.335	28.32 1.115	21.38 .842	23.62 .930	3.40 .134	5.53 .218	5.70 .224	13.34 .525	6.35 .250	3.30 .130	27.69 1.090
37 P / 37 S	37.72 1.485	32.13 1.265	25.19 .992	27.43 1.080	3.40 .134	5.53 .218	5.70 .224	13.34 .525	6.35 .250	3.30 .130	30.23 1.100
51 P / 51 S	36.45 1.435	30.86 1.215	23.92 .942	26.16 1.030	4.50 .177	6.60 .260	6.81 .268	16.76 .660	7.62 .300	3.81 .150	31.24 1.230

SUMMARY OF CHARACTERISTICS

ELECTRICAL & MECHANICAL PERFORMANCE	
CURRENT RATING	3 A max.
CONTACT RESISTANCE	8 mΩ max.
INSULATION RESISTANCE	5000 MΩ min. @ 500 Vdc
DIELECTRIC WITHSTANDING VOLTAGE	Sea level: 600 Vac Altitude 21 km (70,000 ft): 150 Vac
CONTACT ENGAGING FORCE	170 g max. (6 oz)
CONTACT SEPARATING FORCE	14 g min. (0.5 oz)
CONTACT RETENTION	2.26 kg (5 lbs)
DURABILITY	500 mating cycles min.
VIBRATION	20g's – No discontinuity > 1 μs
SHOCK	50g's – No discontinuity > 1 μs

MATERIAL & FINISH	
MOULDED SHELL	Liquid Crystal Polymer (LCP)
PIN CONTACT	Copper and beryllium copper, Gold over nickel plating
SOCKET CONTACT	Copper alloy, gold over nickel plating
ENCAPSULANT	Epoxy resin
MOULDED TRAY	Liquid Crystal Polymer (LCP)
PCB TERMINALS	See ordering info for PCB terminals material
HARDWARE	300 series stainless steel, passivated

SEE PAGE 24 FOR MORE INFORMATION

PCB LAYOUT FOR CBP TYPE 0.100" PITCH - MALE CONNECTORS

VIEW A

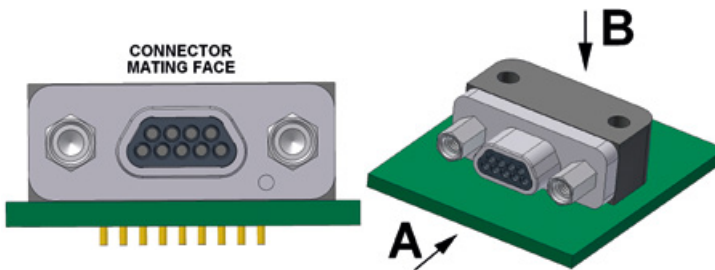

9 CONTACTS - VIEW B

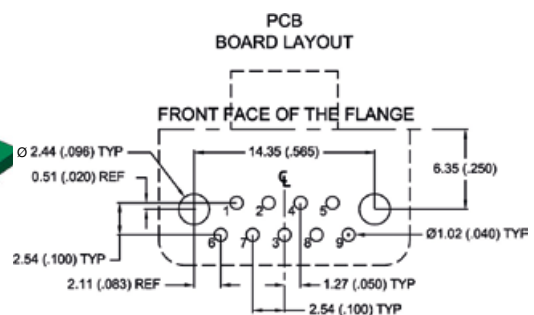

15 CONTACTS - VIEW B

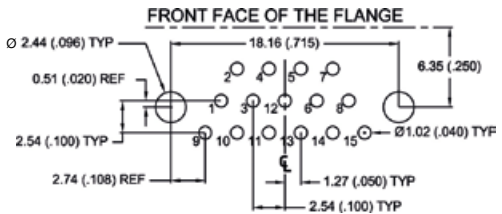

21 CONTACTS - VIEW B

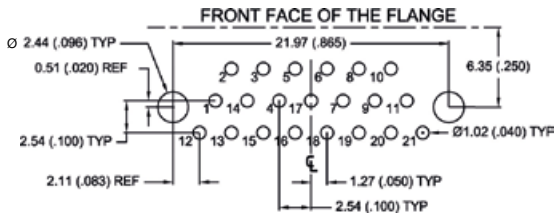

25 CONTACTS - VIEW B

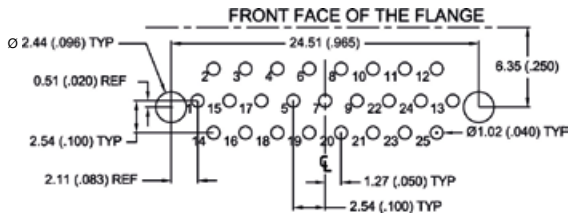

31 CONTACTS - VIEW B

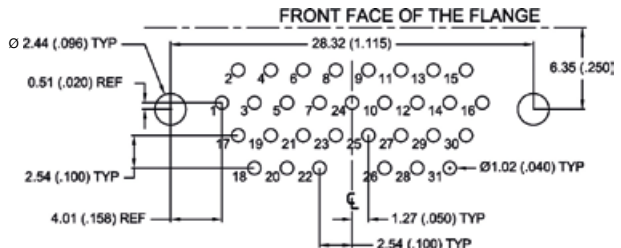

37 CONTACTS - VIEW B

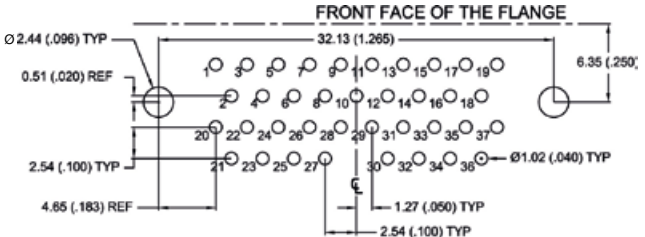

51 CONTACTS - VIEW B

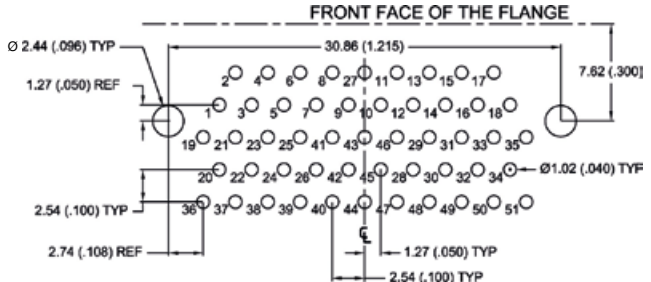

PCB LAYOUT FOR CBP TYPE 0.100" PITCH - FEMALE CONNECTORS

VIEW A

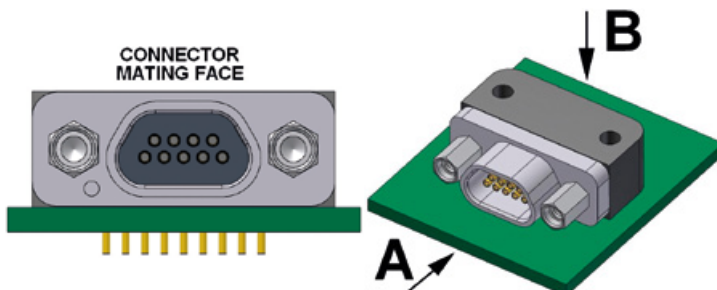

9 CONTACTS - VIEW B

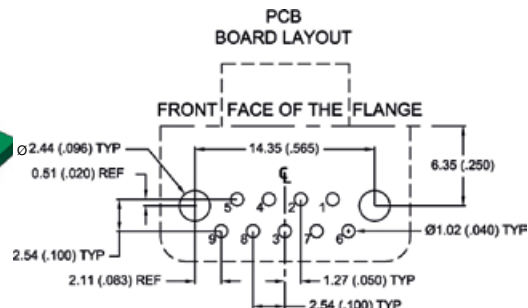

15 CONTACTS - VIEW B

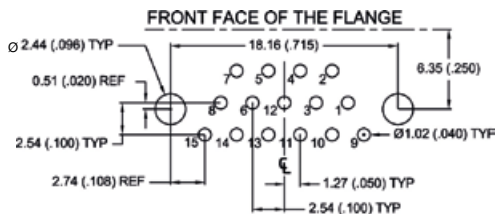

21 CONTACTS - VIEW B

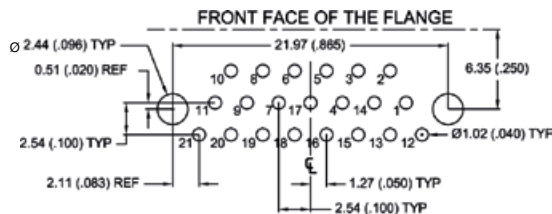

25 CONTACTS - VIEW B

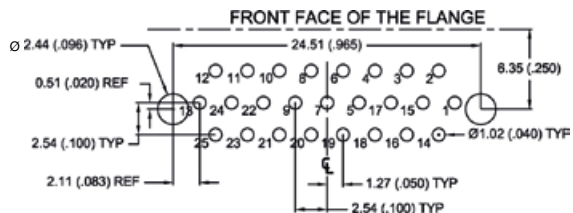

31 CONTACTS - VIEW B

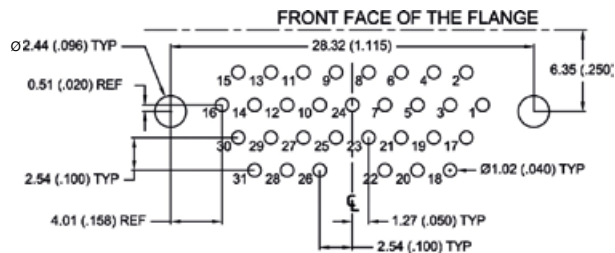

37 CONTACTS - VIEW B

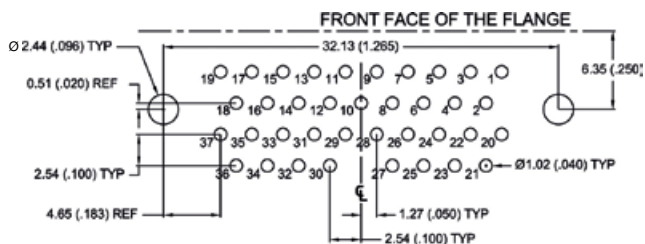

51 CONTACTS - VIEW B

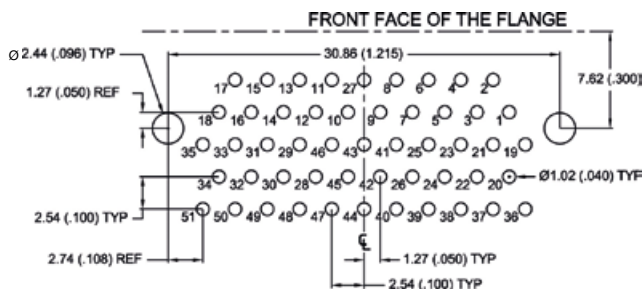

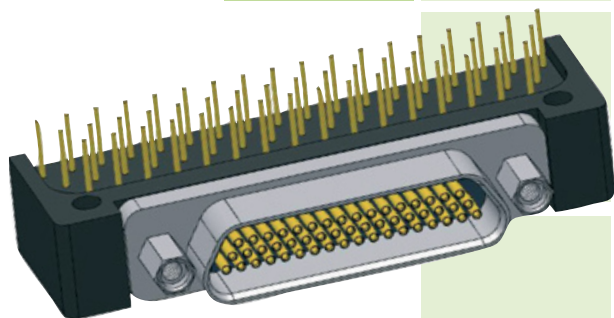

PCB RECTANGULAR CONNECTORS

BR TYPE 0.100" PITCH

METAL SHELL

- Board right angle connector for flexible and rigid printed circuit boards.
- Operating temperature: 150°C or 200°C.
- Several tail lengths available.

PLEASE CONTACT US FOR CLASS P (PLASTIC) BR CONNECTORS.

IDENTIFICATION CODE



SERIES

MDA: Micro-D AXON' standard series.

CONNECTOR TYPE

- 1:** Cadmium al. shell / **Z:** Black zinc nickel aluminium shell + potting 150°C.
2: Nickel aluminium shell + potting 150°C.
3: Nickel aluminium shell + potting 200°C.
S: Passivated stainless steel shell + potting 200°C.

NUMBER OF CONTACTS

09, 15, 21, 25, 31, 37, 51DR, 51, 69, 100.
 See pages 26 & 27 for contact arrangements.

CONNECTOR GENDER

- P:** Male (pin contacts).
S: Female (socket contacts).

PCB VERSION

BR: 0.100" Board Right Angle.

HARDWARE

- B:** No hardware.
P: Jackposts.
Px (x: 1 to 5): Panel mount jackposts.
T: Threaded inserts installed.
W: Jackposts and threaded inserts installed.
Wx (x: 1 to 5): Panel mount jackposts and threaded inserts installed.
 See pages 190 to 200 for hardware description.

CONDUCTOR TYPE

- G:** Gold plated solid conductor AWG 25.
T: Tin plated solid conductor AWG 24.
 See page 29 for conductor types.

TAIL LENGTH

- 1:** 2.80 mm (0.110").
2: 3.80 mm (0.150").
3: 4.80 mm (0.190").
4: 6.35 mm (0.250").
5: 3.25 mm (0.127").
6: 3.56 mm (0.140").
7: 4.37 mm (0.172").

Tolerance: ± 0.38 mm (0.015").
 Other lengths available on request.

DIMENSIONS

Dimensions are in millimetres (inches).

FEMALE connector

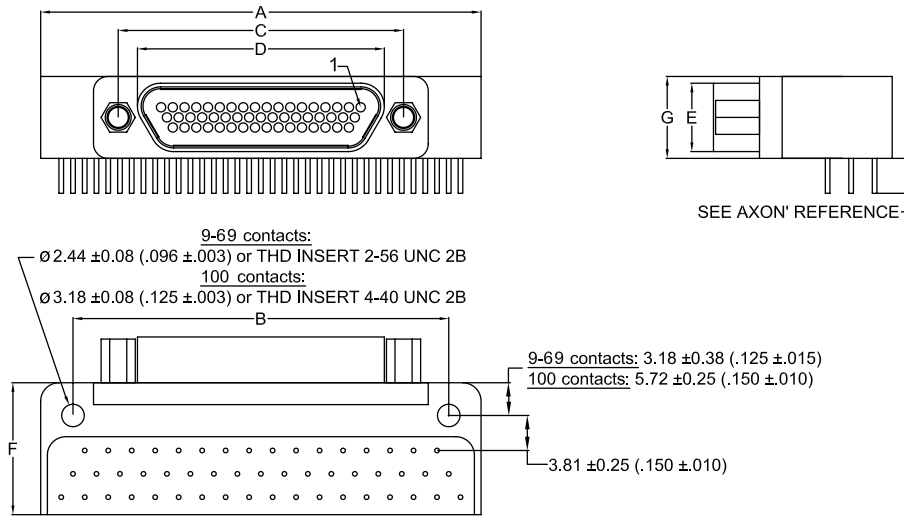

SEE CONTACT LAYOUT ON PCB PAGES 94 TO 97

	A max.	± 0.18 (±.007)	± 0.13 (±.005)	D max.		E max.		F max.	G ± 0.25 (±.010)
				Male	Female	Male	Female		
9 P / 9 S	35.31 1.390	29.21 1.150	14.35 .565	8.48 .334	10.16 .400	4.69 .185	6.35 .250	11.81 .465	7.87 .310
15 P / 15 S	39.12 1.540	33.02 1.300	18.16 .715	12.29 .484	14.00 .551	4.69 .185	6.35 .250	11.81 .465	7.87 .310
21 P / 21 S	42.93 1.690	36.83 1.450	21.97 .865	16.10 .634	17.81 .701	4.69 .185	6.35 .250	11.81 .465	7.87 .310
25 P / 25 S	45.47 1.790	39.37 1.550	24.51 .965	18.64 .734	20.35 .801	4.69 .185	6.35 .250	11.81 .465	7.87 .310
31 P / 31 S	51.82 2.040	45.72 1.800	28.32 1.115	22.45 .883	24.16 .951	4.69 .185	6.35 .250	11.81 .465	7.87 .310
37 P / 37 S	59.44 2.340	53.34 2.100	32.13 1.265	26.26 1.034	27.96 1.101	4.69 .185	6.35 .250	11.81 .465	7.87 .310
51DR P / 51DR S	77.30 3.043	71.12 2.800	41.02 1.615	35.15 1.384	36.83 1.450	4.69 .185	6.35 .250	11.81 .465	7.87 .310
51 P / 51 S	47.63 1.875	40.64 1.600	30.86 1.215	24.99 .984	26.70 1.051	5.79 .228	7.44 .293	14.35 .565	8.76 .345
69 P / 69 S	62.87 2.475	55.88 2.200	38.48 1.515	32.61 1.284	34.29 1.350	5.79 .228	7.44 .293	14.35 .565	8.76 .345
100 P / 100 S	70.61 2.780	63.50 2.500	45.72 1.800	35.15 1.384	36.86 1.451	6.88 .271	8.46 .333	19.43 .765	10.29 .405

SUMMARY OF CHARACTERISTICS

ELECTRICAL & MECHANICAL PERFORMANCE	
CURRENT RATING	3 A max.
CONTACT RESISTANCE	8 mΩ max.
INSULATION RESISTANCE	5000 MΩ min. @ 500 Vdc
DIELECTRIC WITHSTANDING VOLTAGE	Sea level: 600 V _{AC} Altitude 21 km (70,000 ft): 150 V _{AC}
CONTACT ENGAGING FORCE	170 g max. x number of contacts
CONTACT SEPARATING FORCE	14 g min. x number of contacts
CONTACT RETENTION	2.26 kg (5 lbs)
DURABILITY	500 mating cycles min.
VIBRATION	20g's – No discontinuity > 1 μs
SHOCK	50g's – No discontinuity > 1 μs

MATERIAL & FINISH	
SHELL	Aluminium alloy 6061 or 300 series stainless steel, see ordering info for plating options
MOULDED INSULATOR	Liquid Crystal Polymer (LCP)
INTERFACIAL SEAL	Fluorosilicone rubber
PIN CONTACT	Copper and beryllium copper, gold over nickel plating
SOCKET CONTACT	Copper alloy, gold over nickel plating
ENCAPSULANT	Epoxy resin
MOULDED TRAY	Liquid Crystal Polymer (LCP)
PCB TERMINALS	See ordering info for PCB terminals material
HARDWARE	300 series stainless steel, passivated

SEE PAGE 24 FOR MORE INFORMATION

PCB LAYOUT FOR BR TYPE 0.100" PITCH - MALE CONNECTORS

VIEW A

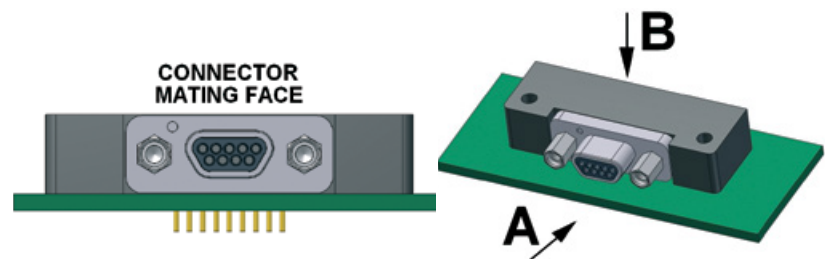

9 CONTACTS - VIEW B

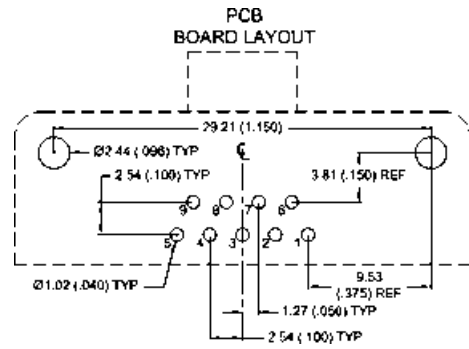

15 CONTACTS - VIEW B

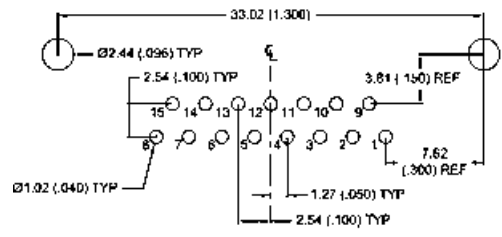

21 CONTACTS - VIEW B

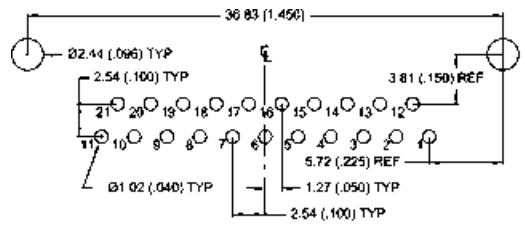

25 CONTACTS - VIEW B

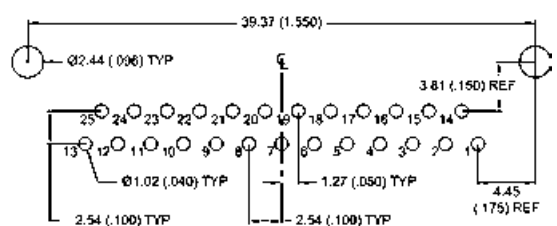

31 CONTACTS - VIEW B

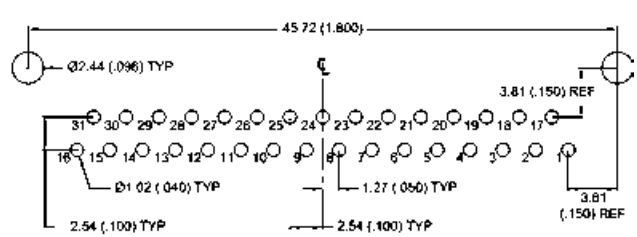

37 CONTACTS - VIEW B

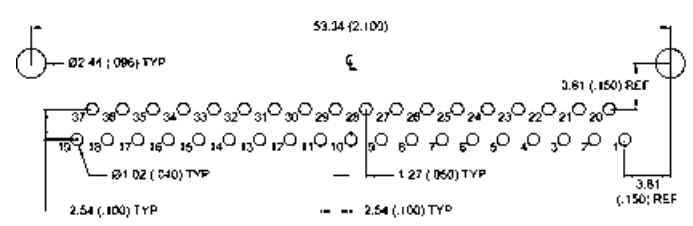

PCB LAYOUT FOR BR TYPE 0.100" PITCH - MALE CONNECTORS

51 CONTACTS (DOUBLE ROW) - VIEW B

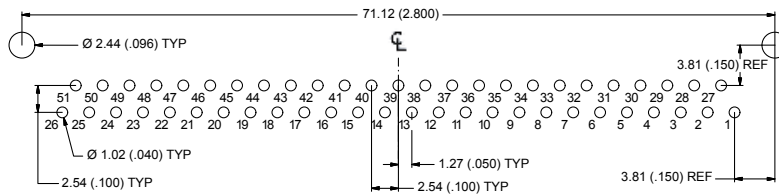

51 CONTACTS - VIEW B

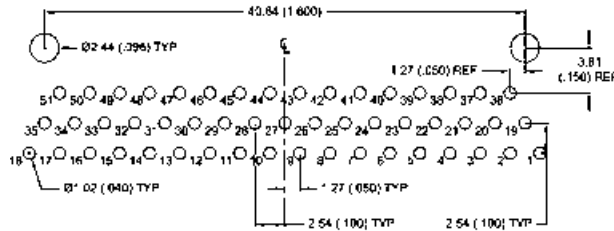

69 CONTACTS - VIEW B

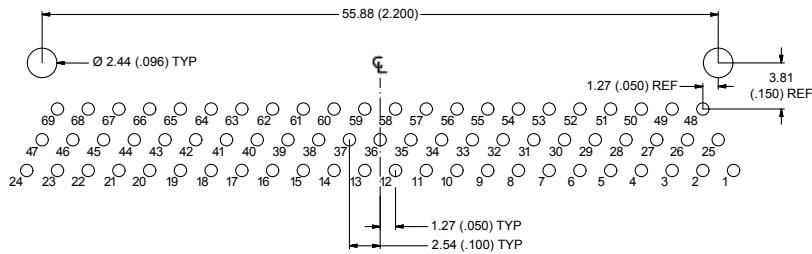

100 CONTACTS - VIEW B

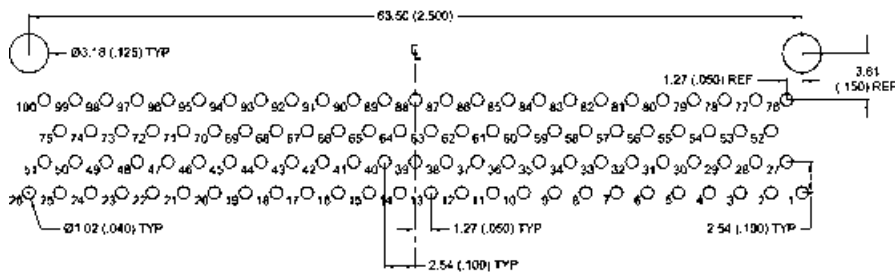

PCB LAYOUT FOR BR TYPE 0.100" PITCH - FEMALE CONNECTORS

VIEW A

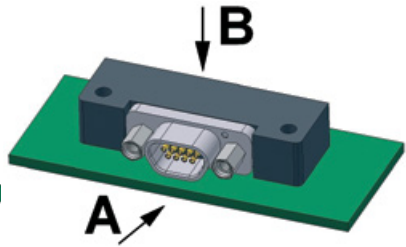

9 CONTACTS - VIEW B

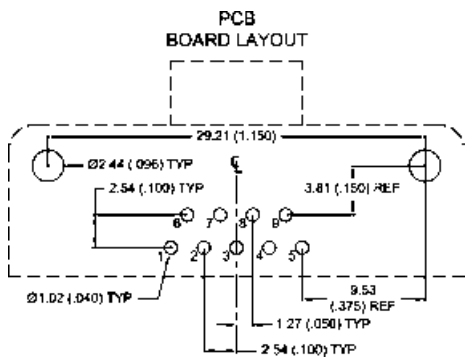

15 CONTACTS - VIEW B

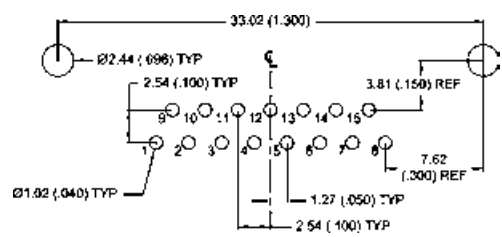

21 CONTACTS - VIEW B

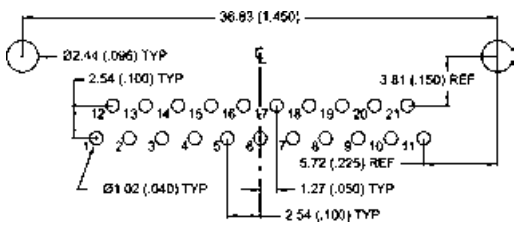

25 CONTACTS - VIEW B

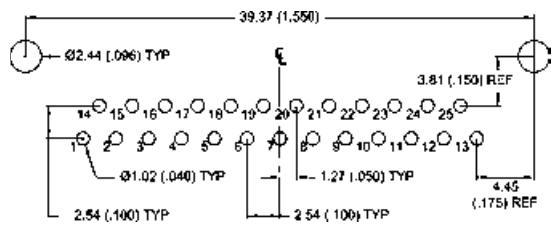

31 CONTACTS - VIEW B

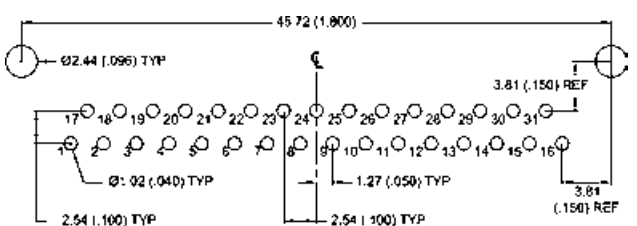

37 CONTACTS - VIEW B

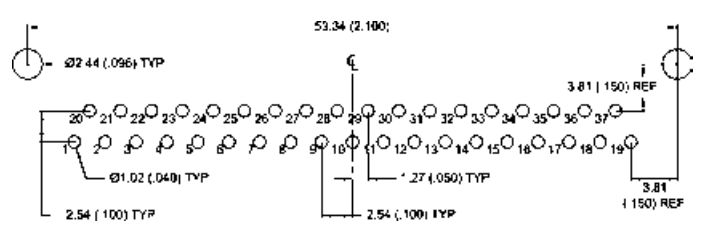

PCB LAYOUT FOR BR TYPE 0.100" PITCH - FEMALE CONNECTORS

51 CONTACTS (DOUBLE ROW) - VIEW B

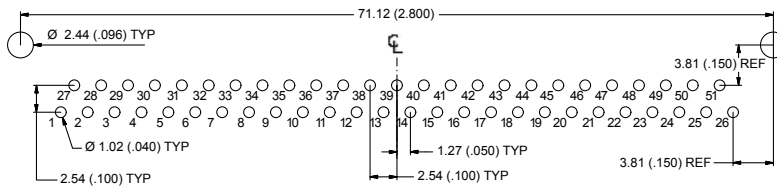

51 CONTACTS - VIEW B

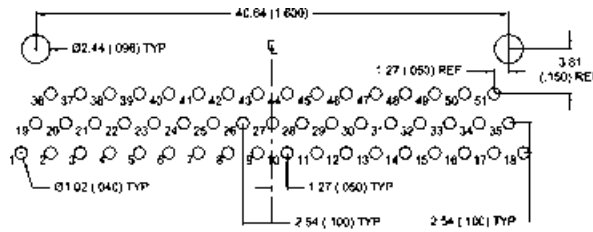

69 CONTACTS - VIEW B

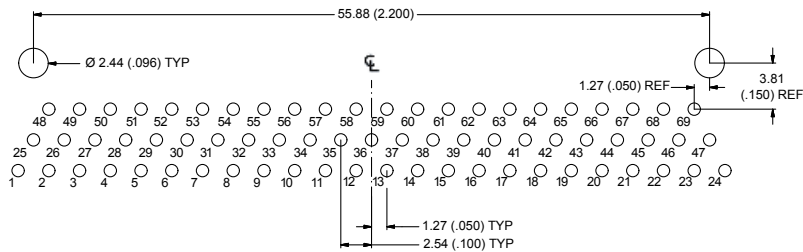

100 CONTACTS - VIEW B

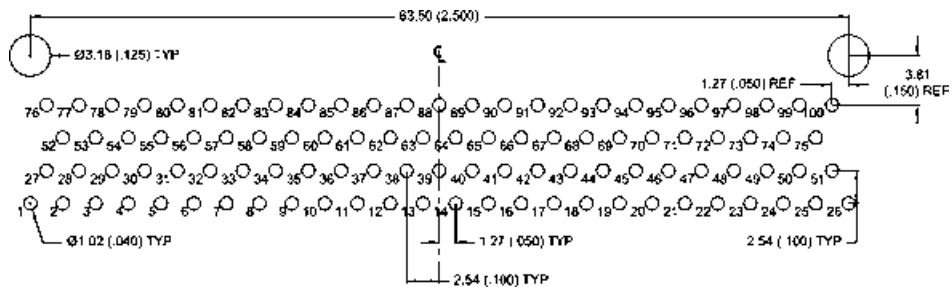

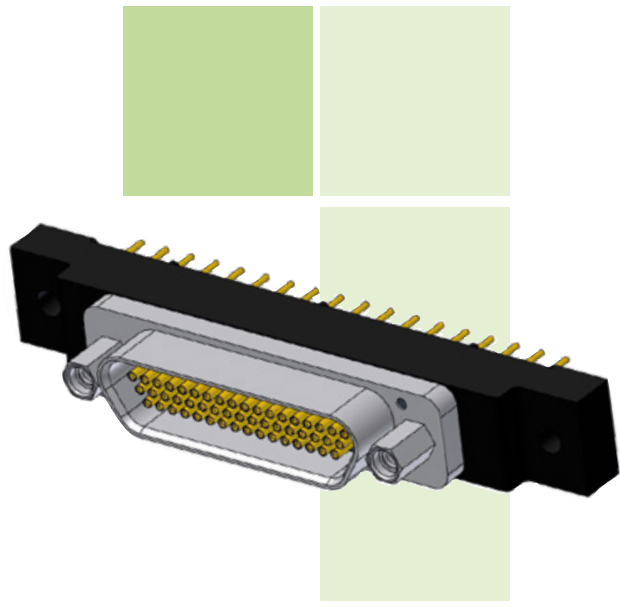

PCB RECTANGULAR CONNECTORS

BS TYPE 0.100" PITCH

METAL SHELL

- Board straight connector for flexible and rigid printed circuit boards.
- Operating temperature: 150°C or 200°C.
- Several tail lengths available.

IDENTIFICATION CODE



SERIES

MDA: Micro-D AXON' standard series.

CONNECTOR TYPE

- 1:** Cadmium al. shell / **Z:** Black zinc nickel aluminium shell + potting 150°C.
- 2:** Nickel aluminium shell + potting 150°C.
- 3:** Nickel aluminium shell + potting 200°C.
- S:** Passivated stainless steel shell + potting 200°C.

NUMBER OF CONTACTS

09, 15, 21, 25, 31, 37, 51DR, 51, 69, 100.
See pages 26 & 27 for contact arrangements.

CONNECTOR GENDER

- P:** Male (pin contacts).
- S:** Female (socket contacts).

PCB VERSION

BS: 0.100" Board Straight.

HARDWARE

- B:** No hardware.
 - P:** Jackposts.
 - Px** (x: 1 to 5): Panel mount jackposts.
 - T:** Threaded inserts installed.
 - W:** Jackposts and threaded inserts installed.
 - Wx** (x: 1 to 5): Panel mount jackposts and threaded inserts installed.
- See pages 190 to 200 for hardware description.

CONDUCTOR TYPE

- G:** Gold plated solid conductor AWG 25.
 - T:** Tin plated solid conductor AWG 24.
- See page 29 for conductor types.

TAIL LENGTH

- 1:** 2.80 mm (0.110").
- 2:** 3.80 mm (0.150").
- 3:** 4.80 mm (0.190").
- 4:** 6.35 mm (0.250").
- 5:** 3.25 mm (0.127").
- 6:** 3.56 mm (0.140").
- 7:** 4.37 mm (0.172").

Tolerance: ± 0.38 mm (0.015").
Other lengths available on request.

DIMENSIONS

Dimensions are in millimetres (inches).

FEMALE connector

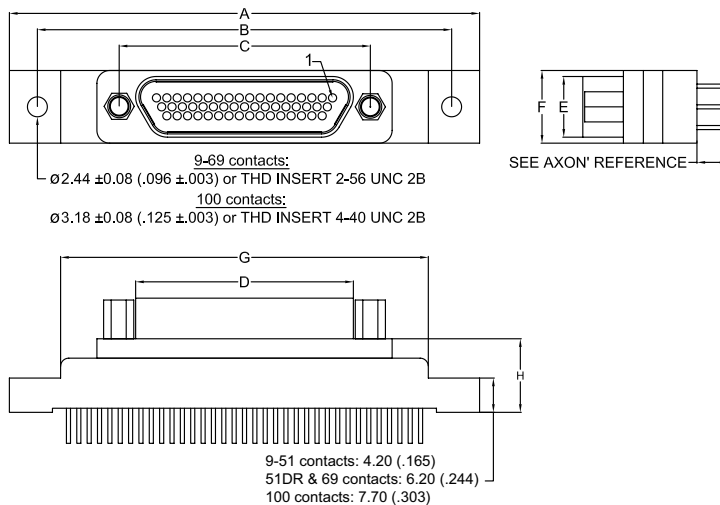

SEE CONTACT LAYOUT ON PCB PAGES 102 & 105

	A max.	B ± 0.18 (±.007)	C ± 0.13 (±.005)	D max.		E max.		F max.	G max.	H max.
				Male	Female	Male	Female			
9 P / 9 S	35.31 1.390	29.21 1.150	14.35 .565	8.48 .334	10.16 .400	4.69 .185	6.35 .250	7.82 .308	19.94 .785	9.02 .355
15 P / 15 S	35.31 1.390	29.21 1.150	18.16 .715	12.29 .484	14.00 .551	4.69 .185	6.35 .250	7.82 .308	24.00 .945	9.02 .355
21 P / 21 S	42.93 1.690	36.83 1.450	21.97 .865	16.10 .634	17.81 .701	4.69 .185	6.35 .250	7.82 .308	29.72 1.170	9.02 .355
25 P / 25 S	44.20 1.740	38.10 1.500	24.51 .965	18.64 .734	20.35 .801	4.69 .185	6.35 .250	7.82 .308	32.39 1.275	9.02 .355
31 P / 31 S	51.82 2.040	45.72 1.800	28.32 1.115	22.45 .883	24.16 .951	4.69 .185	6.35 .250	7.82 .308	40.01 1.575	9.02 .355
37 P / 37 S	59.44 2.340	53.34 2.100	32.13 1.265	26.26 1.034	27.96 1.101	4.69 .185	6.35 .250	7.82 .308	47.63 1.875	9.02 .355
51DR P / 51DR S	77.30 3.043	71.12 2.800	41.02 1.615	35.15 1.384	36.83 1.450	4.69 .185	6.35 .250	7.82 .308	65.47 2.578	11.02 .434
51 P / 51 S	57.66 2.270	50.80 2.000	30.86 1.215	24.99 .984	26.70 1.051	5.79 .228	7.44 .293	8.92 .351	45.09 1.775	9.02 .355
69 P / 69 S	72.90 2.870	66.04 2.600	38.48 1.515	32.61 1.284	34.29 1.350	5.79 .228	7.44 .293	8.92 .351	60.33 2.375	11.02 .434
100 P / 100 S	82.55 3.250	71.12 2.800	45.72 1.800	35.15 1.384	36.86 1.451	6.88 .271	8.46 .333	11.68 .460	65.66 2.585	13.97 .550

SUMMARY OF CHARACTERISTICS

ELECTRICAL & MECHANICAL PERFORMANCE	
CURRENT RATING	3 A max.
CONTACT RESISTANCE	8 mΩ max.
INSULATION RESISTANCE	5000 MΩ min. @ 500 V _{dc}
DIELECTRIC WITHSTANDING VOLTAGE	Sea level: 600 V _{ac} Altitude 21 km: 150 V _{ac}
CONTACT ENGAGING FORCE	170 g max. (6 oz)
CONTACT SEPARATING FORCE	14 g min. (0.5 oz)
CONTACT RETENTION	2.26 kg (5 lbs)
DURABILITY	500 mating cycles min.
VIBRATION	20g's – No discontinuity > 1 μs
SHOCK	50g's – No discontinuity > 1 μs

MATERIAL & FINISH	
SHELL	Aluminium alloy 6061 or 300 series stainless steel, see ordering info for plating options
MOULDED INSULATOR	Liquid Crystal Polymer (LCP)
INTERFACIAL SEAL	Fluorosilicone rubber
PIN CONTACT	Copper and beryllium copper, gold over nickel plating
SOCKET CONTACT	Copper alloy, gold over nickel plating
ENCAPSULANT	Epoxy resin
MOULDED TRAY	Liquid Crystal Polymer (LCP)
PCB TERMINALS	See ordering info for PCB terminals material
HARDWARE	300 series stainless steel, passivated

SEE PAGE 24 FOR MORE INFORMATION

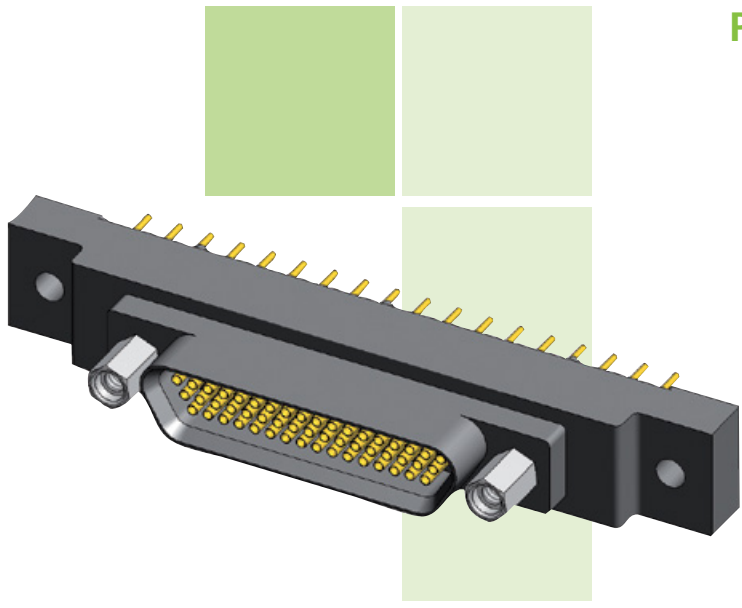

PCB RECTANGULAR CONNECTORS

BS TYPE
0.100" PITCH

PLASTIC SHELL

- Board straight connector for flexible and rigid printed circuit boards.
- Operating temperature: 150°C or 200°C.
- Several tail lengths available.

IDENTIFICATION CODE



SERIES

MDA: Micro-D AXON' standard series.

CONNECTOR TYPE

P: LCP shell + potting 150°C.
L: LCP shell + potting 200°C.

NUMBER OF CONTACTS

09, 15, 21, 25, 31, 37, 51.
See pages 26 & 27 for contact arrangements.

CONNECTOR GENDER

P: Male (pin contacts).
S: Female (socket contacts).

PCB VERSION

BS: 0.100" Board Straight.

HARDWARE

B: No hardware.
P: Jackposts.
Px (x: 1 to 5): Panel mount jackposts.
T: Threaded inserts installed.
W: Jackposts and threaded inserts installed.
Wx (x: 1 to 5): Panel mount jackposts and threaded inserts installed.
See pages 190 to 200 for hardware description.

CONDUCTOR TYPE

G: Gold plated solid conductor AWG 25.
T: Tin plated solid conductor AWG 24.
See page 29 for conductor types.

TAIL LENGTH

- 1:** 2.80 mm (0.110").
- 2:** 3.80 mm (0.150").
- 3:** 4.80 mm (0.190").
- 4:** 6.35 mm (0.250").
- 5:** 3.25 mm (0.127").
- 6:** 3.56 mm (0.140").
- 7:** 4.37 mm (0.172").

Tolerance: ± 0.38 mm (0.015").
Other lengths available on request.

DIMENSIONS

Dimensions are in millimetres (inches).

FEMALE connector

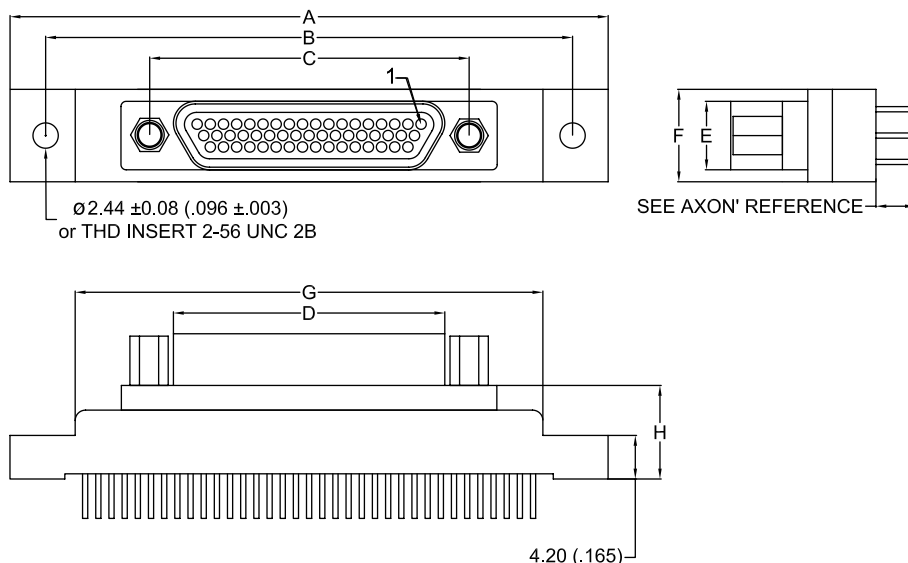

SEE CONTACT LAYOUT ON PCB PAGES 102 & 105

	A max.	B ± 0.18 (±.007)	C ± 0.13 (±.005)	D max.		E max.		F max.	G max.	H max.
				Male	Female	Male	Female			
9 P / 9 S	35.31 1.390	29.21 1.150	14.35 .565	7.41 .292	9.65 .380	3.40 .134	5.53 .218	7.82 .308	22.48 .885	9.02 .355
15 P / 15 S	35.31 1.390	29.21 1.150	18.16 .715	11.22 .442	13.46 .530	3.40 .134	5.53 .218	7.82 .308	24.00 .945	9.02 .355
21 P / 21 S	42.93 1.690	36.83 1.450	21.97 .865	15.03 .592	17.27 .680	3.40 .134	5.53 .218	7.82 .308	30.10 1.185	9.02 .355
25 P / 25 S	44.20 1.740	38.10 1.500	24.51 .965	17.57 .692	19.81 .780	3.40 .134	5.53 .218	7.82 .308	32.39 1.275	9.02 .355
31 P / 31 S	51.82 2.040	45.72 1.800	28.32 1.115	21.38 .842	23.62 .930	3.40 .134	5.53 .218	7.82 .308	40.01 1.575	9.02 .355
37 P / 37 S	59.44 2.340	53.34 2.100	32.13 1.265	25.19 .992	27.43 1.080	3.40 .134	5.53 .218	7.82 .308	47.63 1.875	9.02 .355
51 P / 51 S	57.66 2.270	50.80 2.000	30.86 1.215	23.92 .942	26.16 1.030	4.50 .177	6.60 .260	8.92 .351	45.09 1.775	9.02 .355

SUMMARY OF CHARACTERISTICS

ELECTRICAL & MECHANICAL PERFORMANCE	
CURRENT RATING	3 A max.
CONTACT RESISTANCE	8 mΩ max.
INSULATION RESISTANCE	5000 MΩ min. @ 500 V _{dc}
DIELECTRIC WITHSTANDING VOLTAGE	Sea level: 600 V _{ac} Altitude 21 km (70,000 ft): 150 V _{ac}
CONTACT ENGAGING FORCE	170 g max. (6 oz)
CONTACT SEPARATING FORCE	14 g min. (0.5 oz)
CONTACT RETENTION	2.26 kg (5 lbs)
DURABILITY	500 mating cycles min.
VIBRATION	20g's – No discontinuity > 1 μs
SHOCK	50g's – No discontinuity > 1 μs

MATERIAL & FINISH	
MOULDED SHELL	Liquid Crystal Polymer (LCP)
PIN CONTACT	Copper and beryllium copper, Gold over nickel plating
SOCKET CONTACT	Copper alloy, gold over nickel plating
ENCAPSULANT	Epoxy resin
MOULDED TRAY	Liquid Crystal Polymer (LCP)
PCB TERMINALS	See ordering info for PCB terminals material
HARDWARE	300 series stainless steel, passivated

SEE PAGE 24 FOR MORE INFORMATION

PCB LAYOUT FOR BS TYPE 0.100" PITCH - MALE CONNECTORS

VIEW A

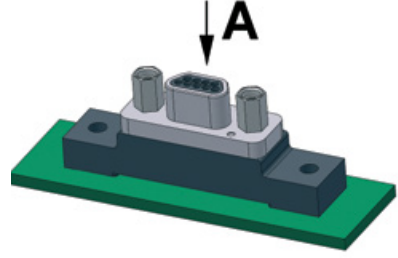

9 CONTACTS - VIEW A

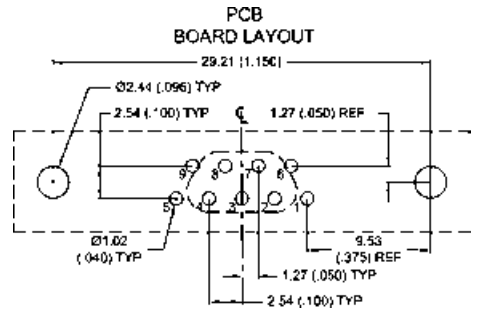

15 CONTACTS - VIEW A

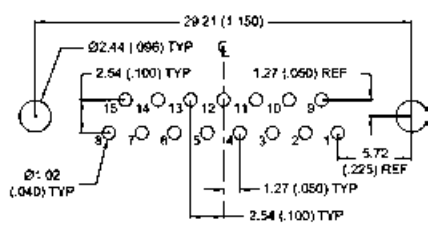

21 CONTACTS - VIEW A

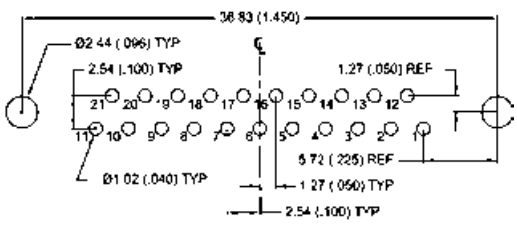

25 CONTACTS - VIEW A

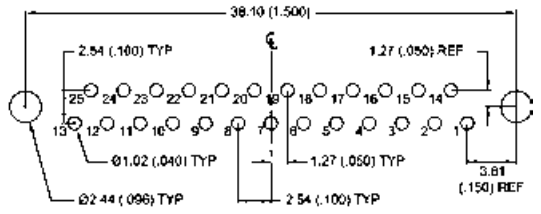

31 CONTACTS - VIEW A

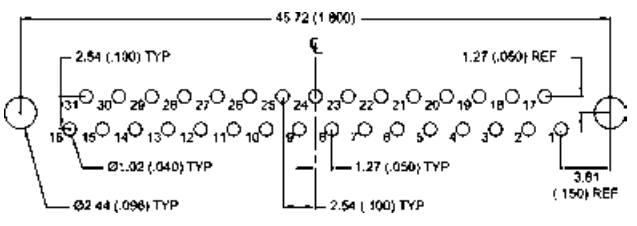

37 CONTACTS - VIEW A

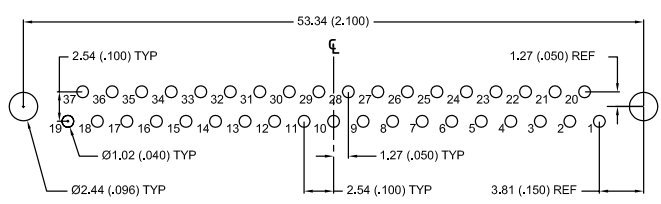

PCB LAYOUT FOR BS TYPE 0.100" PITCH - MALE CONNECTORS

51 CONTACTS (DOUBLE ROW) - VIEW A

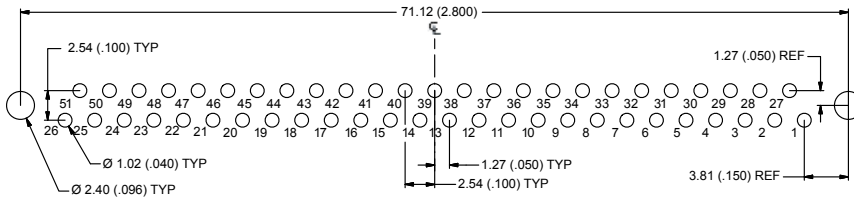

51 CONTACTS - VIEW A

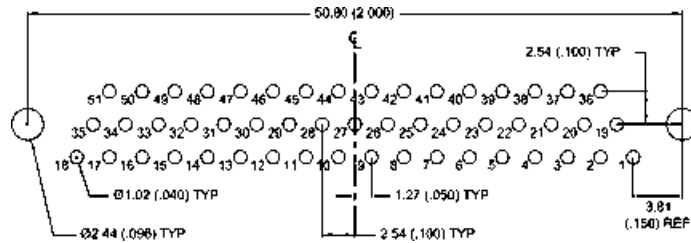

69 CONTACTS - VIEW A

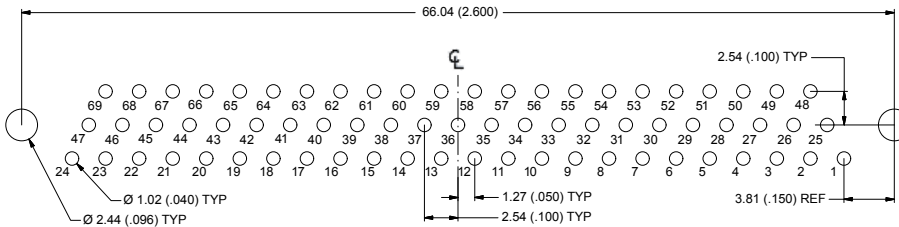

100 CONTACTS - VIEW A

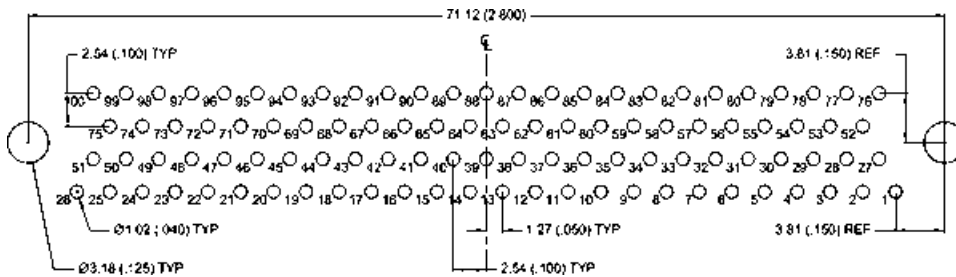

PCB LAYOUT FOR BS TYPE 0.100" PITCH - FEMALE CONNECTORS

VIEW A

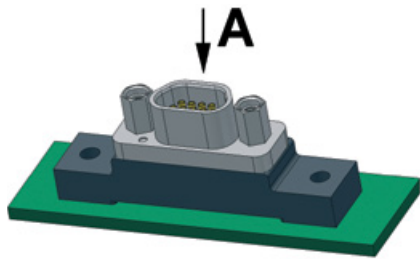

9 CONTACTS - VIEW A

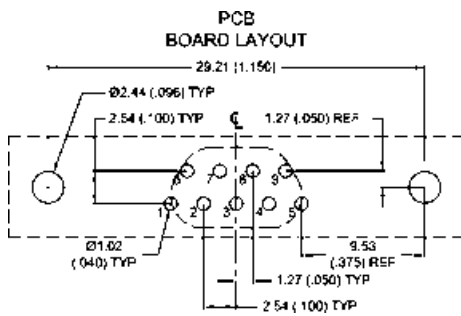

15 CONTACTS - VIEW A

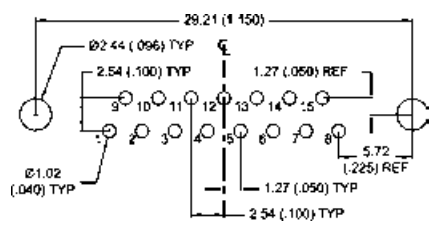

21 CONTACTS - VIEW A

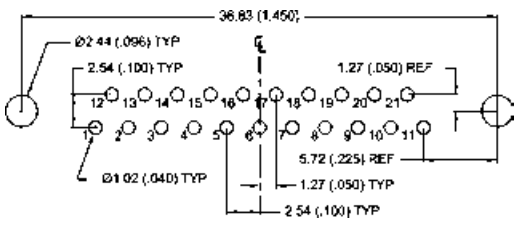

25 CONTACTS - VIEW A

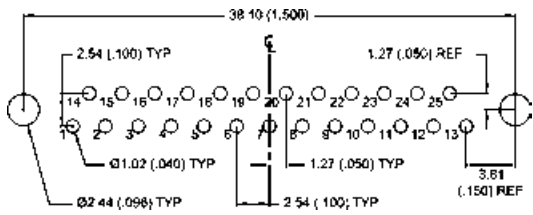

31 CONTACTS - VIEW A

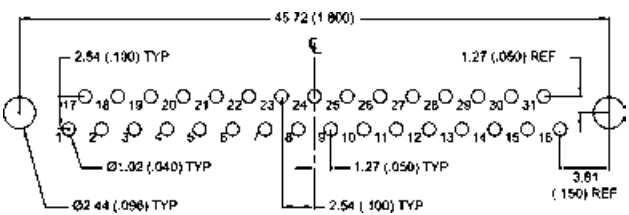

37 CONTACTS - VIEW A

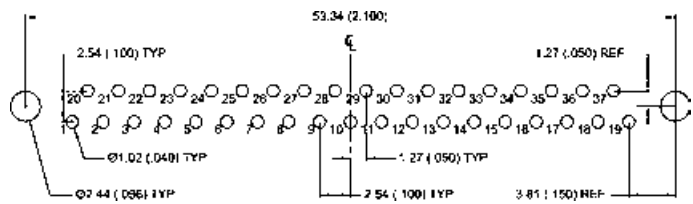

PCB LAYOUT FOR BS TYPE 0.100" PITCH - FEMALE CONNECTORS

51 CONTACTS (DOUBLE ROW) - VIEW A

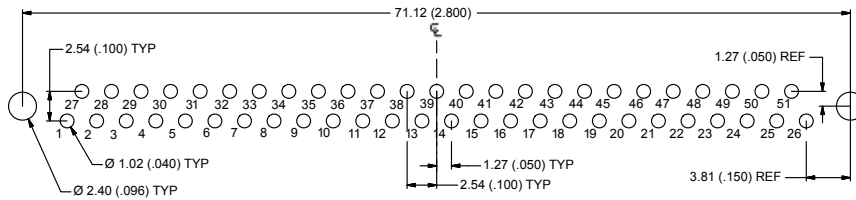

51 CONTACTS - VIEW A

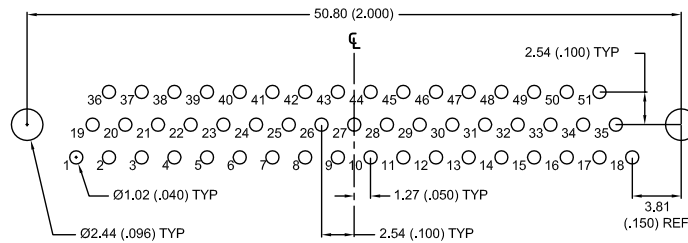

69 CONTACTS - VIEW A

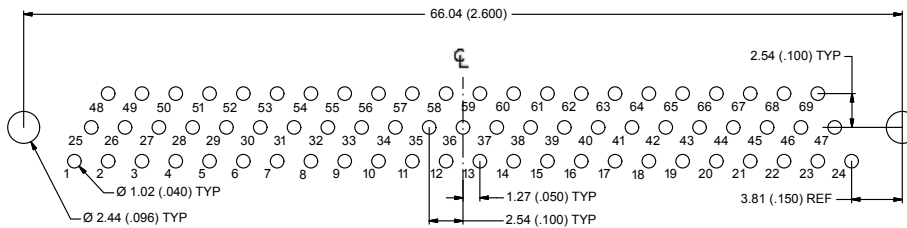

100 CONTACTS - VIEW A

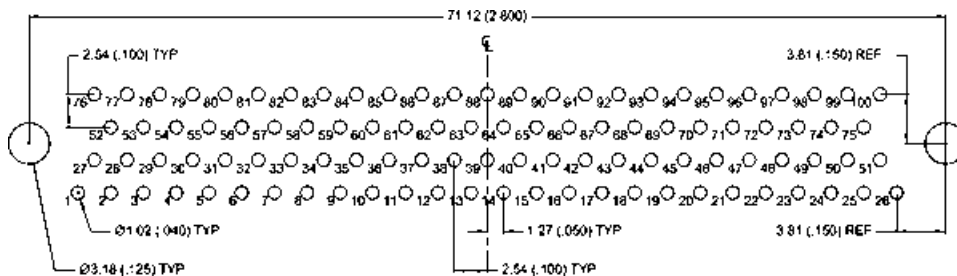

PCB RECTANGULAR CONNECTORS

CBR TYPE

0.075" PITCH

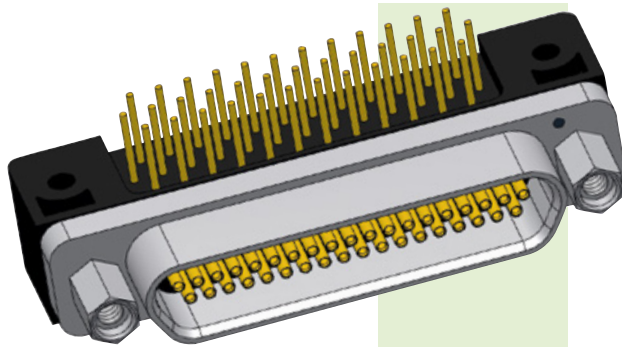

METAL SHELL

- Condensed board right angle connector for flexible and rigid printed circuit boards.
- Operating temperature: 150°C or 200°C.
- Several tail lengths available.

PLEASE CONTACT US FOR A PLASTIC VERSION OF 0.075" RIGHT ANGLE CONNECTOR.

IDENTIFICATION CODE



SERIES

MDA: Micro-D AXON' standard series.

CONNECTOR TYPE

- 1:** Cadmium al. shell / **Z:** Black zinc nickel aluminium shell + potting 150°C.
2: Nickel aluminium shell + potting 150°C.
3: Nickel aluminium shell + potting 200°C.
S: Passivated stainless steel shell + potting 200°C.

NUMBER OF CONTACTS

09, 15, 21, 25, 31, 37, 51DR, 51, 69, 100.
See pages 26 & 27 for contact arrangements.

CONNECTOR GENDER

- P:** Male (pin contacts).
S: Female (socket contacts).

PCB VERSION

75RB: 0.075" pitch condensed board right angle specific layout.
Other option available 75RC see page 112.

HARDWARE

- B:** No hardware.
P: Jackposts.
Px (x: 1 to 5): Panel mount jackposts.
T: Threaded inserts installed.
W: Jackposts and threaded inserts installed.
Wx (x: 1 to 5): Panel mount jackposts and threaded inserts installed.
See pages 190 to 200 for hardware description.

CONDUCTOR TYPE

- G:** Gold plated solid conductor AWG 25.
T: Tin plated solid conductor AWG 24.
See page 29 for conductor types.

TAIL LENGTH

- 1:** 2.80 mm (0.110").
2: 3.80 mm (0.150").
3: 4.80 mm (0.190").
4: 6.35 mm (0.250").
5: 3.25 mm (0.127").
6: 3.56 mm (0.140").
7: 4.37 mm (0.172").

Tolerance: ± 0.38 mm (0.015").
Other lengths available on request.

METAL CONNECTORS ARE SUPPLIED WITH ANTI-STATIC PROTECTIVE DUST CAPS

DIMENSIONS

Dimensions are in millimetres (inches).

FEMALE connector

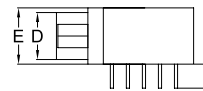
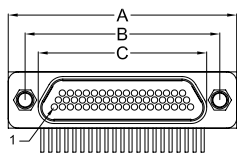

SEE AXON' REFERENCE

9-69 way connectors

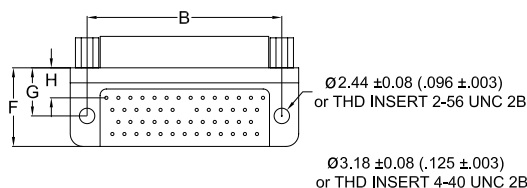

100 way connectors

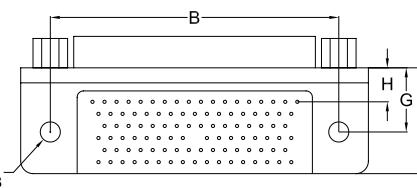

SEE CONTACT LAYOUT ON PCB PAGES 108 TO 111

	A max.	B ± 0.13 (±.005)	C max.		D max.		E max.	F max.	G ± 0.25 (±.010)	H ± 0.25 (±.010)
			Male	Female	Male	Female				
9 P / 9 S	19.94 .785	14.35 .565	8.48 .334	10.16 .400	4.69 .185	6.35 .250	7.82 .308	10.16 .400	6.35 .250	5.40 .213
15 P / 15 S	23.75 .935	18.16 .715	12.29 .484	14.00 .551	4.69 .185	6.35 .250	7.82 .308	10.16 .400	6.35 .250	4.45 .175
21 P / 21 S	27.56 1.085	21.97 .865	16.10 .634	17.81 .701	4.69 .185	6.35 .250	7.82 .308	10.16 .400	6.35 .250	4.45 .175
25 P / 25 S	30.10 1.185	24.51 .965	18.64 .734	20.35 .801	4.69 .185	6.35 .250	7.82 .308	10.16 .400	6.35 .250	4.45 .175
31 P / 31 S	33.91 1.335	28.32 1.115	22.45 .883	24.16 .951	4.69 .185	6.35 .250	7.82 .308	10.16 .400	6.35 .250	4.45 .175
37 P / 37 S	37.72 1.485	32.13 1.265	26.26 1.034	27.96 1.101	4.69 .185	6.35 .250	7.82 .308	10.16 .400	6.35 .250	4.45 .175
51DR P / 51DR S	46.61 1.835	41.02 1.615	35.15 1.384	36.83 1.450	4.69 .185	6.35 .250	7.82 .308	10.16 .400	6.35 .250	4.45 .175
51 P / 51 S	36.45 1.435	30.86 1.215	24.99 .984	26.70 1.051	5.79 .228	7.44 .293	8.92 .351	12.45 .490	7.62 .300	4.76 .188
69 P / 69 S	44.07 1.735	38.48 1.515	32.61 1.284	34.29 1.350	5.79 .228	7.44 .293	8.92 .351	12.45 .490	7.62 .300	4.76 .188
100 P / 100 S	55.12 2.170	45.72 1.800	35.15 1.384	36.86 1.451	6.88 .271	8.46 .333	10.01 .394	16.76 .660	10.16 .400	5.40 .213

SUMMARY OF CHARACTERISTICS

ELECTRICAL & MECHANICAL PERFORMANCE	
CURRENT RATING	3 A max.
CONTACT RESISTANCE	8 mΩ max.
INSULATION RESISTANCE	5000 MΩ min. @ 500 Vdc
DIELECTRIC WITHSTANDING VOLTAGE	Sea level: 600 Vac Altitude 21 km (70,000 ft): 150 Vac
CONTACT ENGAGING FORCE	170 g max. (6 oz)
CONTACT SEPARATING FORCE	14 g min. (0.5 oz)
CONTACT RETENTION	2.26 kg (5 lbs)
DURABILITY	500 mating cycles min.
VIBRATION	20g's - No discontinuity > 1 μs
SHOCK	50g's - No discontinuity > 1 μs

MATERIAL & FINISH	
SHELL	Aluminium alloy 6061 or 300 series stainless steel, see ordering info for plating options
MOULDED INSULATOR	Liquid Crystal Polymer (LCP)
INTERFACIAL SEAL	Fluorosilicone rubber
PIN CONTACT	Copper and beryllium copper, gold over nickel plating
SOCKET CONTACT	Copper alloy, gold over nickel plating
ENCAPSULANT	Epoxy resin
MOULDED TRAY	Liquid Crystal Polymer (LCP)
PCB TERMINALS	See ordering info for PCB terminals material
HARDWARE	300 series stainless steel, passivated

SEE PAGE 24 FOR MORE INFORMATION

**PCB LAYOUT FOR CBR TYPE
0.075" PITCH - MALE CONNECTORS**

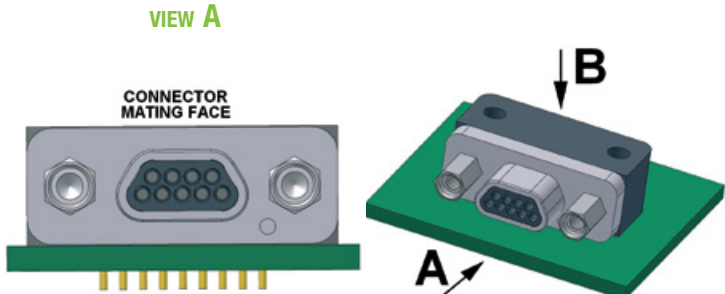

9 CONTACTS - VIEW B

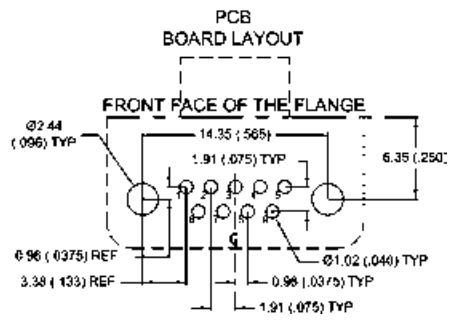

15 CONTACTS - VIEW B

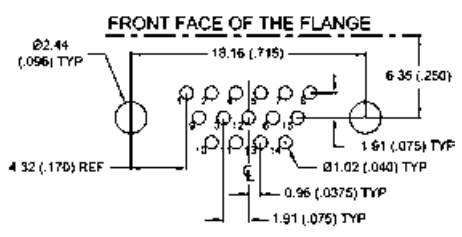

21 CONTACTS - VIEW B

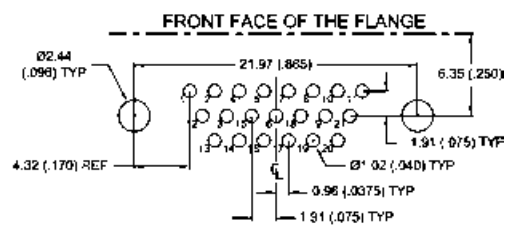

25 CONTACTS - VIEW B

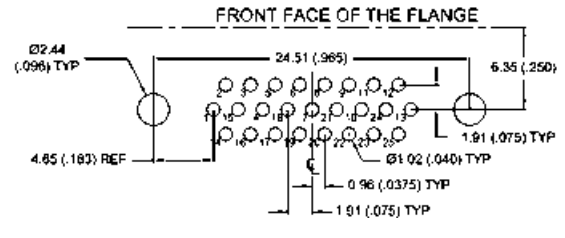

31 CONTACTS - VIEW B

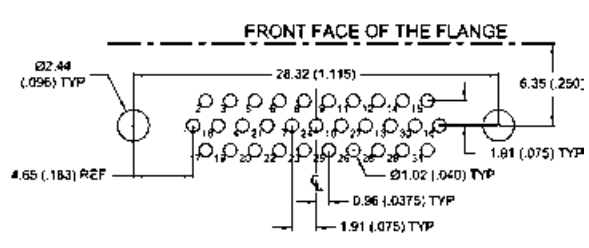

37 CONTACTS - VIEW B

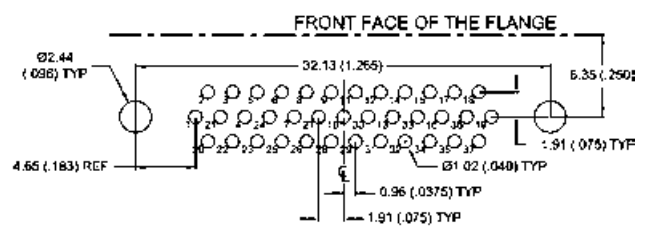

PCB LAYOUT FOR CBR TYPE 0.075" PITCH - MALE CONNECTORS

51 CONTACTS (DOUBLE ROW) - VIEW B

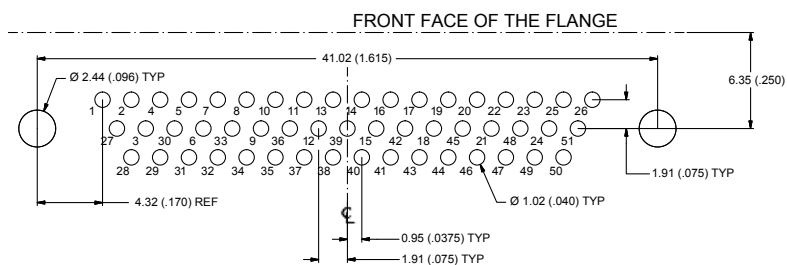

51 CONTACTS - VIEW B

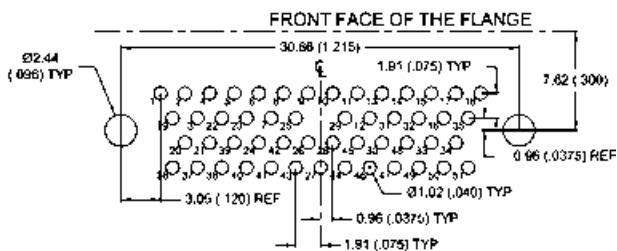

69 CONTACTS - VIEW B

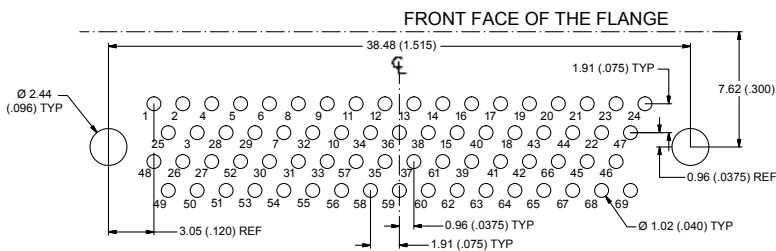

100 CONTACTS - VIEW B

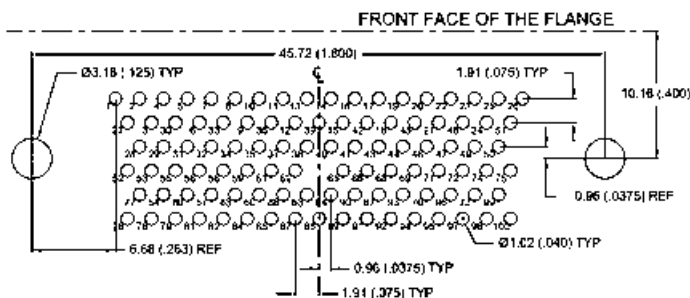

PCB LAYOUT FOR CBR TYPE 0.075" PITCH - FEMALE CONNECTORS

VIEW A

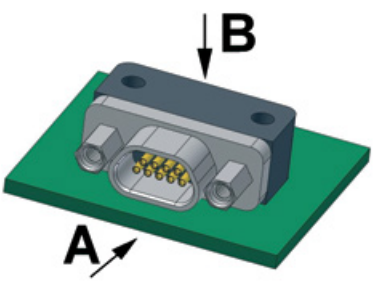
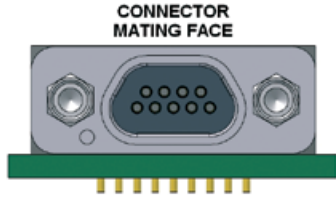

9 CONTACTS - VIEW B

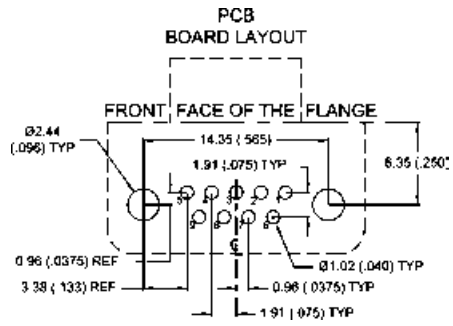

15 CONTACTS - VIEW B

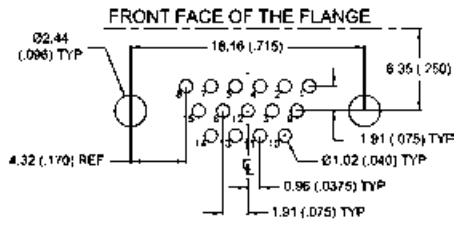

21 CONTACTS - VIEW B

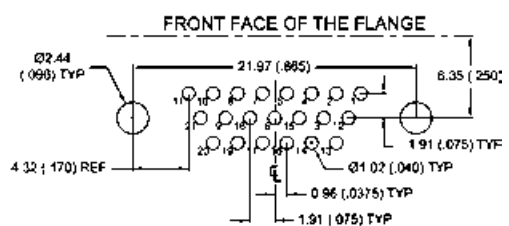

25 CONTACTS - VIEW B

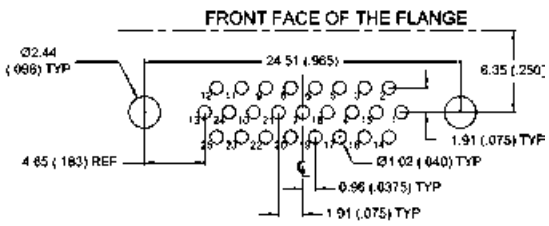

31 CONTACTS - VIEW B

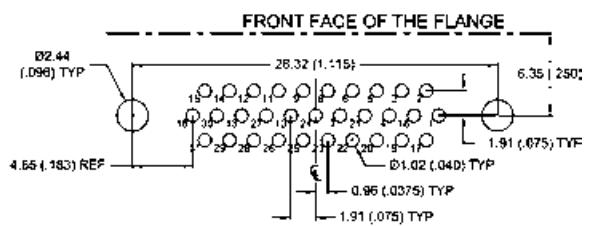

37 CONTACTS - VIEW B

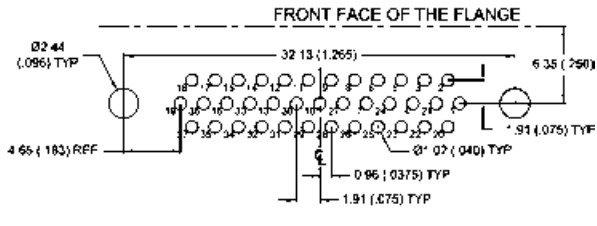

PCB LAYOUT FOR CBR TYPE 0.075" PITCH - FEMALE CONNECTORS

51 CONTACTS (DOUBLE ROW) - VIEW B

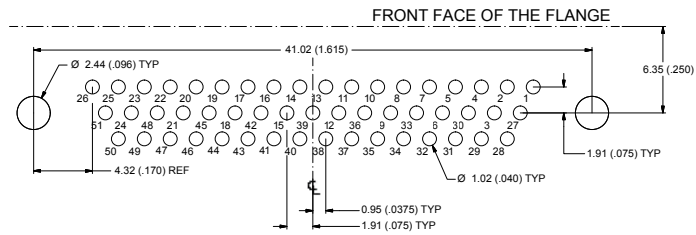

51 CONTACTS - VIEW B

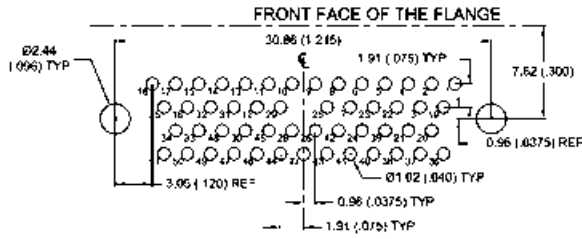

69 CONTACTS - VIEW B

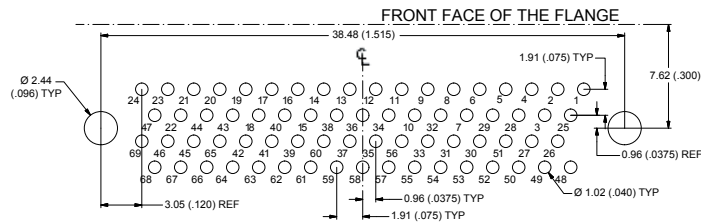

100 CONTACTS - VIEW B

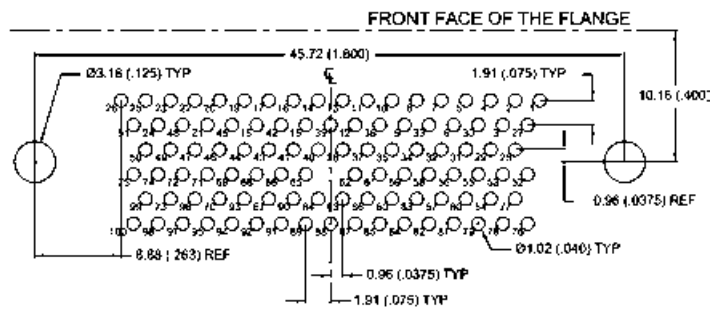

PCB RECTANGULAR CONNECTORS

CBR TYPE
0.075" PITCH

**METAL SHELL
BASED ON BS
MIL STANDARD LAYOUT**

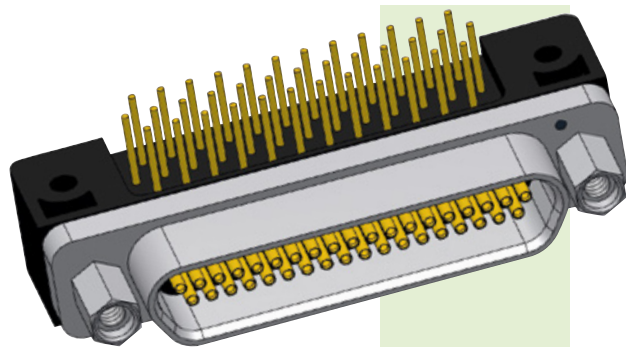

- Condensed board right angle connector for flexible and rigid printed circuit boards.
- Operating temperature: 150°C or 200°C.
- Several tail lengths available.

PLEASE CONTACT US FOR A PLASTIC VERSION OF 0.075" RIGHT ANGLE CONNECTOR.

IDENTIFICATION CODE



SERIES

MDA: Micro-D AXON' standard series.

CONNECTOR TYPE

- 1:** Cadmium al. shell / **Z:** Black zinc nickel aluminium shell + potting 150°C.
- 2:** Nickel aluminium shell + potting 150°C.
- 3:** Nickel aluminium shell + potting 200°C.
- S:** Passivated stainless steel shell + potting 200°C.

NUMBER OF CONTACTS

09, 15, 21, 25, 31, 37, 51, 69, 100.
See pages 26 & 27 for contact arrangements.

CONNECTOR GENDER

- P:** Male (pin contacts).
- S:** Female (socket contacts).

PCB VERSION

75RC: 0.075" pitch condensed board right angle based on BS MIL standard layout.
Other option available 75RB see page 106.

HARDWARE

- B:** No hardware.
- P:** Jackposts.
- Px** (x: 1 to 5): Panel mount jackposts.
- T:** Threaded inserts installed.
- W:** Jackposts and threaded inserts installed.
- Wx** (x: 1 to 5): Panel mount jackposts and threaded inserts installed.
See pages 190 to 200 for hardware description.

CONDUCTOR TYPE

- G:** Gold plated solid conductor AWG 25.
- T:** Tin plated solid conductor AWG 24.
See page 29 for conductor types.

TAIL LENGTH

- 1:** 2.80 mm (0.110").
- 2:** 3.80 mm (0.150").
- 3:** 4.80 mm (0.190").
- 4:** 6.35 mm (0.250").
- 5:** 3.25 mm (0.127").
- 6:** 3.56 mm (0.140").
- 7:** 4.37 mm (0.172").

Tolerance: ± 0.38 mm (0.015").
Other lengths available on request.

METAL CONNECTORS ARE SUPPLIED WITH ANTI-STATIC PROTECTIVE DUST CAPS

DIMENSIONS

Dimensions are in millimetres (inches).

FEMALE connector

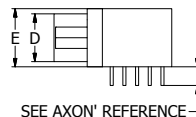
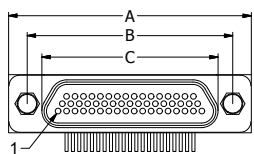

9-51 way connectors

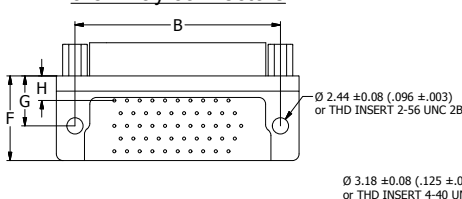

100 way connectors

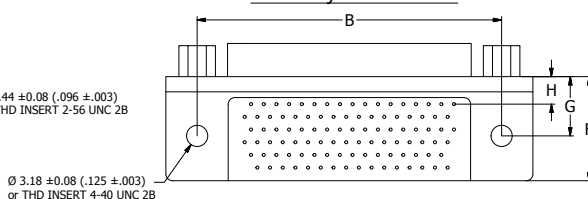

SEE CONTACT LAYOUT ON PCB PAGES 114 TO 115

	A max.	B ± 0.13 (±.005)	C max.		D max.		E max.	F max.	G ± 0.25 (±.010)	H ± 0.25 (±.010)
			Male	Female	Male	Female				
9 P / 9 S	19.94 .785	14.35 .565	8.48 .334	10.16 .400	4.69 .185	6.35 .250	7.82 .308	10.60 .417	6.35 .250	3.49 .138
15 P / 15 S	23.75 .935	18.16 .715	12.29 .484	14.00 .551	4.69 .185	6.35 .250	7.82 .308	10.60 .417	6.35 .250	3.49 .138
21 P / 21 S	27.56 1.085	21.97 .865	16.10 .634	17.81 .701	4.69 .185	6.35 .250	7.82 .308	10.60 .417	6.35 .250	3.49 .138
25 P / 25 S	30.10 1.185	24.51 .965	18.64 .734	20.35 .801	4.69 .185	6.35 .250	7.82 .308	10.60 .417	6.35 .250	3.49 .138
31 P / 31 S	33.91 1.335	28.32 1.115	22.45 .883	24.16 .951	4.69 .185	6.35 .250	7.82 .308	10.60 .417	6.35 .250	3.49 .138
37 P / 37 S	37.72 1.485	32.13 1.265	26.26 1.034	27.96 1.101	4.69 .185	6.35 .250	7.82 .308	10.60 .417	6.35 .250	3.49 .138
51 P / 51 S	36.45 1.435	30.86 1.215	24.99 .984	26.70 1.051	5.79 .228	7.44 .293	8.92 .351	12.90 .508	7.49 .295	3.68 .145
69 P / 69 S	44.07 1.735	38.48 1.515	32.61 1.284	34.29 1.350	5.79 .228	7.44 .293	8.92 .351	12.90 .508	7.49 .295	3.68 .145
100 P / 100 S	55.12 2.170	45.72 1.800	35.15 1.384	36.86 1.451	6.88 .271	8.46 .333	10.01 .394	15.80 .622	8.89 .350	4.13 .163

SUMMARY OF CHARACTERISTICS

ELECTRICAL & MECHANICAL PERFORMANCE	
CURRENT RATING	3 A max.
CONTACT RESISTANCE	8 mΩ max.
INSULATION RESISTANCE	5000 MΩ min. @ 500 Vdc
DIELECTRIC WITHSTANDING VOLTAGE	Sea level: 600 Vac Altitude 21 km (70,000 ft): 150 Vac
CONTACT ENGAGING FORCE	170 g max. (6 oz)
CONTACT SEPARATING FORCE	14 g min. (0.5 oz)
CONTACT RETENTION	2.26 kg (5 lbs)
DURABILITY	500 mating cycles min.
VIBRATION	20g's – No discontinuity > 1 μs
SHOCK	50g's – No discontinuity > 1 μs

MATERIAL & FINISH	
SHELL	Aluminium alloy 6061 or 300 series stainless steel, see ordering info for plating options
MOULDED INSULATOR	Liquid Crystal Polymer (LCP)
INTERFACIAL SEAL	Fluorosilicone rubber
PIN CONTACT	Copper and beryllium copper, gold over nickel plating
SOCKET CONTACT	Copper alloy, gold over nickel plating
ENCAPSULANT	Epoxy resin
MOULDED TRAY	Liquid Crystal Polymer (LCP)
PCB TERMINALS	See ordering info for PCB terminals material
HARDWARE	300 series stainless steel, passivated

SEE PAGE 24 FOR MORE INFORMATION

PCB LAYOUT FOR CBR TYPE - 0.075" PITCH BASED ON BS MIL STANDARD LAYOUT - MALE CONNECTORS

VIEW A

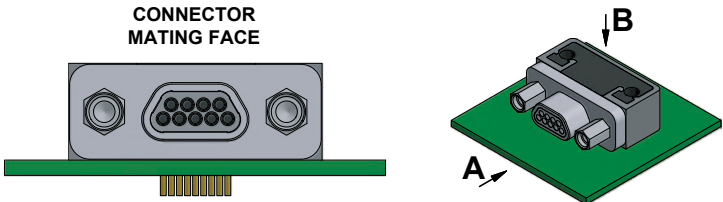

9 CONTACTS - VIEW B

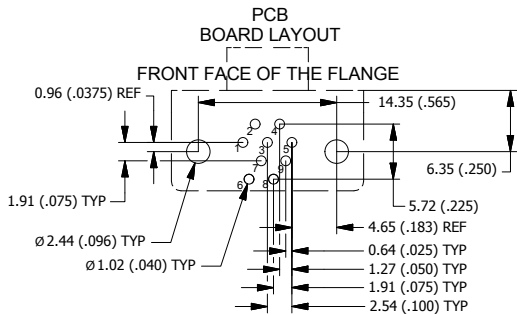

15 CONTACTS - VIEW B

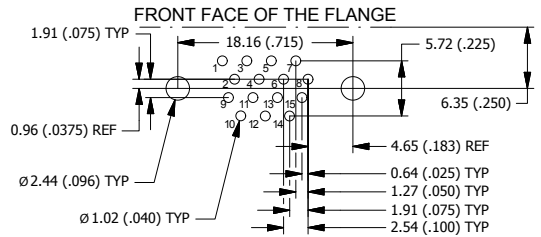

21 CONTACTS - VIEW B

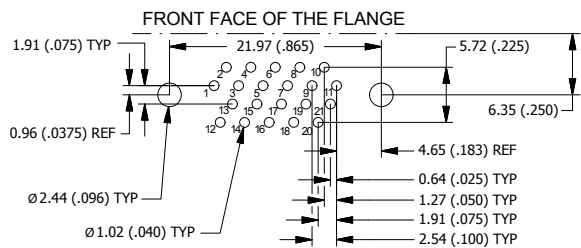

25 CONTACTS - VIEW B

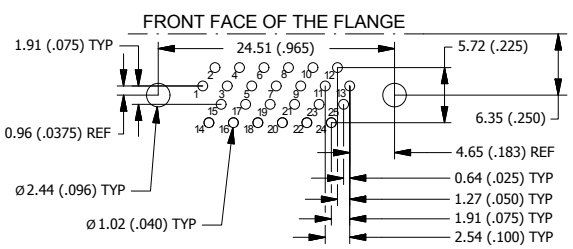

31 CONTACTS - VIEW B

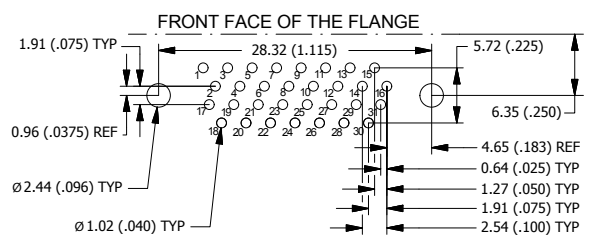

37 CONTACTS - VIEW B

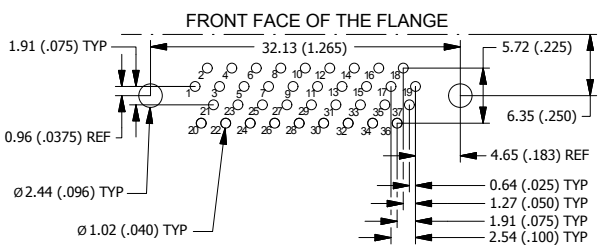

51 CONTACTS - VIEW B

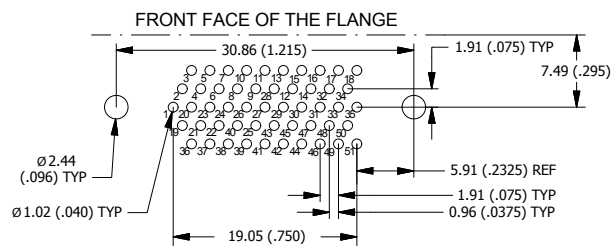

69 CONTACTS - VIEW B

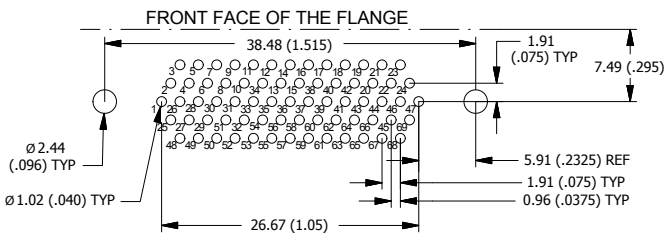

100 CONTACTS - VIEW B

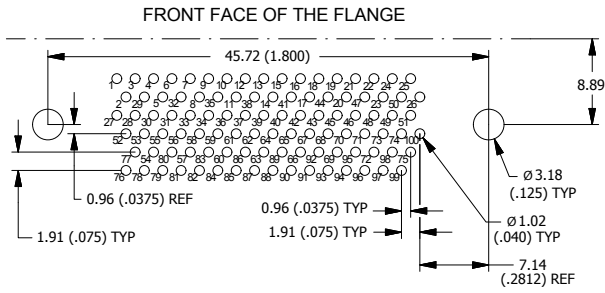

PCB LAYOUT FOR CBR TYPE - 0.075" PITCH BASED ON BS MIL STANDARD LAYOUT - FEMALE CONNECTORS

VIEW A

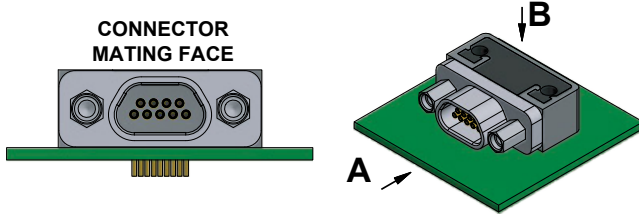

9 CONTACTS - VIEW B

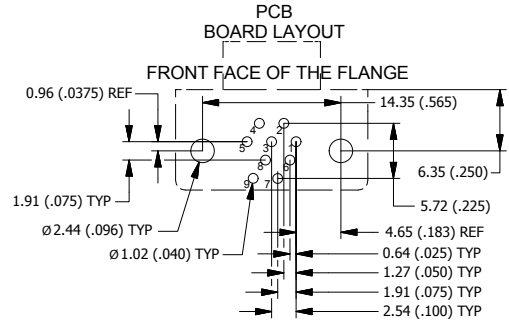

15 CONTACTS - VIEW B

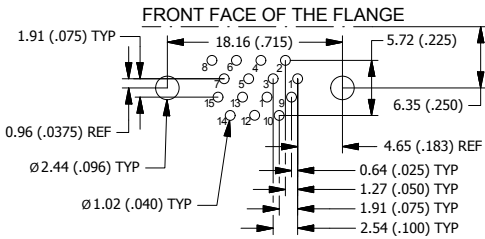

21 CONTACTS - VIEW B

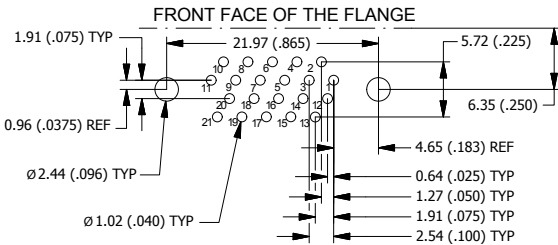

25 CONTACTS - VIEW B

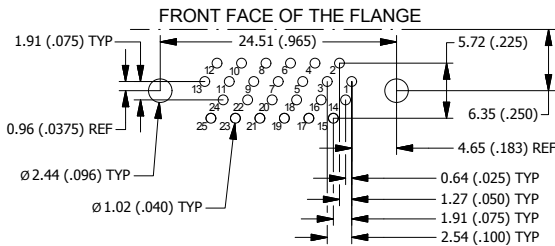

31 CONTACTS - VIEW B

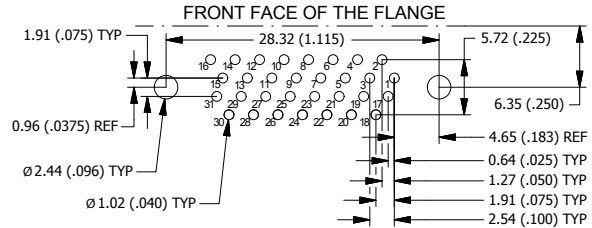

37 CONTACTS - VIEW B

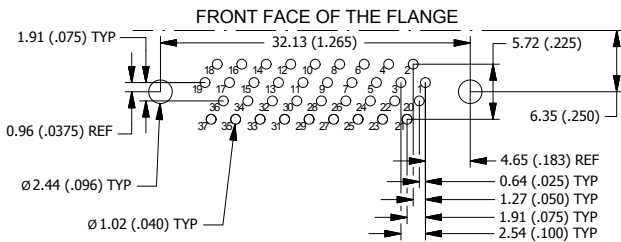

51 CONTACTS - VIEW B

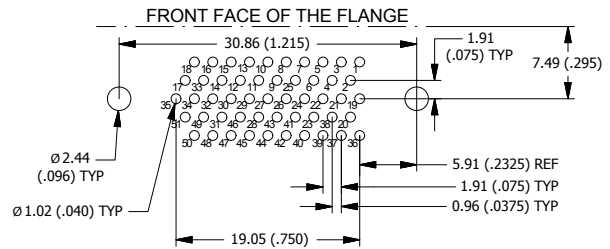

69 CONTACTS - VIEW B

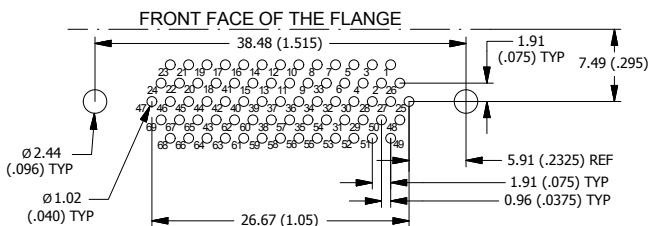

100 CONTACTS - VIEW B

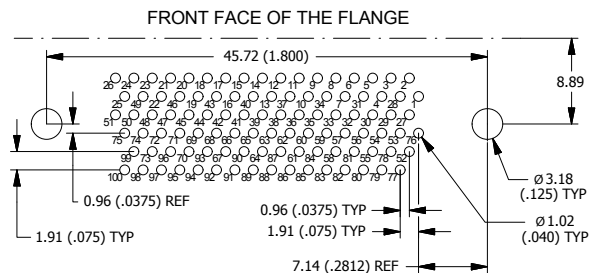

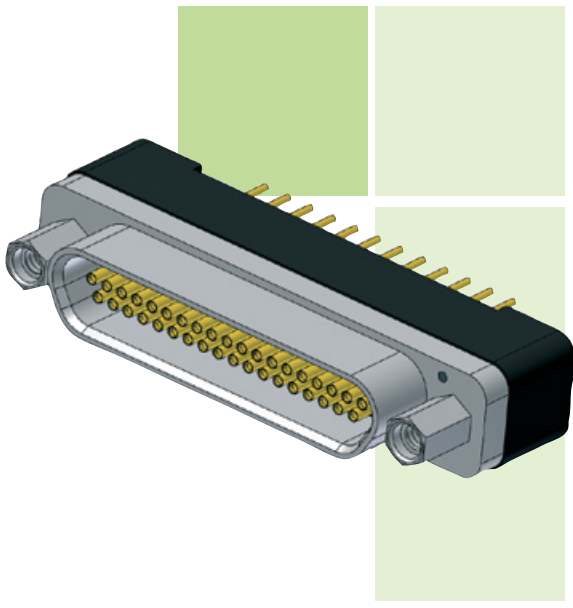

PCB RECTANGULAR CONNECTORS

BS TYPE
0.075" PITCH

METAL SHELL

- Board straight connector for flexible and rigid printed circuit boards.
- Operating temperature: 150°C or 200°C.
- Several tail lengths available.

IDENTIFICATION CODE



SERIES

MDA: Micro-D AXON' standard series.

CONNECTOR TYPE

- 1:** Cadmium al. shell / **Z:** Black zinc nickel aluminium shell + potting 150°C.
- 2:** Nickel aluminium shell + potting 150°C.
- 3:** Nickel aluminium shell + potting 200°C.
- S:** Passivated stainless steel shell + potting 200°C.

NUMBER OF CONTACTS

09, 15, 21, 25, 31, 37, 51DR*, 51, 69*, 100.

***: 51DR & 69 ways are available for 75SB PCB version only**
See pages 26 & 27 for contact arrangements.

CONNECTOR GENDER

- P:** Male (pin contacts).
- S:** Female (socket contacts).

PCB VERSION

75SA: 0.075" pitch board straight MIL standard layout.
75SB: 0.075" pitch board straight specific layout.

HARDWARE

- B:** No hardware.
- P:** Jackposts.
- Px** (x: 1 to 5): Panel mount jackposts.
- T:** Threaded inserts installed.
- W:** Jackposts and threaded inserts installed.
- Wx** (x: 1 to 5): Panel mount jackposts and threaded inserts installed.
See pages 190 to 200 for hardware description.

CONDUCTOR TYPE

- G:** Gold plated solid conductor AWG 25.
- T:** Tin plated solid conductor AWG 24.
See page 29 for conductor types.

TAIL LENGTH

- 1:** 2.80 mm (0.110").
- 2:** 3.80 mm (0.150").
- 3:** 4.80 mm (0.190").
- 4:** 6.35 mm (0.250").
- 5:** 3.25 mm (0.127").
- 6:** 3.56 mm (0.140").
- 7:** 4.37 mm (0.172").

Tolerance: ± 0.38 mm (0.015").
Other lengths available on request.

METAL CONNECTORS ARE SUPPLIED WITH ANTI-STATIC PROTECTIVE DUST CAPS

DIMENSIONS

Dimensions are in millimetres (inches).

FEMALE connector

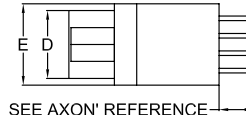
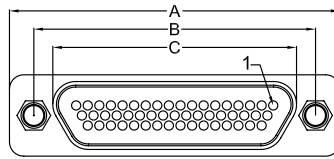

SEE AXON' REFERENCE

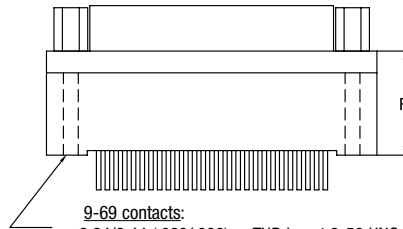

9-69 contacts:
 $\varnothing 2.24/2.44$ (.088/.096) or THD insert 2-56 UNC 2B
 100 contacts:
 $\varnothing 3.68/3.81$ (.145/.150) or THD insert 4-40 UNC 2B

SEE CONTACT LAYOUT ON PCB PAGES 120 TO 125

	A max.	B ± 0.13 ($\pm .005$)	C max.		D max.		E max.	F max.
			Male	Female	Male	Female		
9 P / 9 S	19.94 .785	14.35 .565	8.48 .334	10.16 .400	4.69 .185	6.35 .250	7.87 .310	9.02 .355
15 P / 15 S	23.75 .935	18.16 .715	12.29 .484	14.00 .551	4.69 .185	6.35 .250	7.87 .310	9.02 .355
21 P / 21 S	27.56 1.085	21.97 .865	16.10 .634	17.81 .701	4.69 .185	6.35 .250	7.87 .310	9.02 .355
25 P / 25 S	30.10 1.185	24.51 .965	18.64 .734	20.35 .801	4.69 .185	6.35 .250	7.87 .310	9.02 .355
31 P / 31 S	33.91 1.335	28.32 1.115	22.45 .883	24.16 .951	4.69 .185	6.35 .250	7.87 .310	9.02 .355
37 P / 37 S	37.72 1.485	32.13 1.265	26.26 1.034	27.96 1.101	4.69 .185	6.35 .250	7.87 .310	9.02 .355
51DR P / 51DR S	46.61 1.835	41.02 1.615	35.15 1.384	36.83 1.450	4.69 .185	6.35 .250	7.87 .310	9.02 .355
51 P / 51 S	36.45 1.435	30.86 1.215	24.99 .984	26.70 1.051	5.79 .228	7.44 .293	10.16 .400	9.02 .355
69 P / 69 S	44.07 1.735	38.48 1.515	32.61 1.284	34.29 1.350	5.79 0.228	7.44 .293	10.16 .400	9.02 .355
100 P / 100 S	55.12 2.170	45.72 1.800	35.15 1.384	36.86 1.451	6.88 .271	8.46 .333	12.95 .510	10.92 .430

SUMMARY OF CHARACTERISTICS

ELECTRICAL & MECHANICAL PERFORMANCE	
CURRENT RATING	3 A max.
CONTACT RESISTANCE	8 m Ω max.
INSULATION RESISTANCE	5000 M Ω min. @ 500 Vdc
DIELECTRIC WITHSTANDING VOLTAGE	Sea level: 600 Vac Altitude 21 km (70,000 ft): 150 Vac
CONTACT ENGAGING FORCE	170 g max. (6 oz)
CONTACT SEPARATING FORCE	14 g min. (0.5 oz)
CONTACT RETENTION	2.26 kg (5 lbs)
DURABILITY	500 mating cycles min.
VIBRATION	20g's - No discontinuity > 1 μ s
SHOCK	50g's - No discontinuity > 1 μ s

MATERIAL & FINISH	
SHELL	Aluminium alloy 6061 or 300 series stainless steel, see ordering info for plating options
MOULDED INSULATOR	Liquid Crystal Polymer (LCP)
INTERFACIAL SEAL	Fluorosilicone rubber
PIN CONTACT	Copper and beryllium copper, gold over nickel plating
SOCKET CONTACT	Copper alloy, gold over nickel plating
ENCAPSULANT	Epoxy resin
MOULDED TRAY	Liquid Crystal Polymer (LCP)
PCB TERMINALS	See ordering info for PCB terminals material
HARDWARE	300 series stainless steel, passivated

SEE PAGE 24 FOR MORE INFORMATION

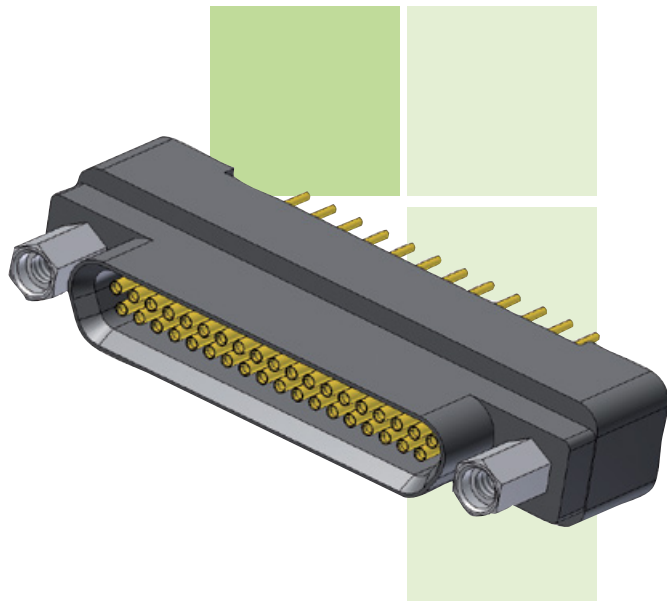

PCB RECTANGULAR CONNECTORS

BS TYPE
0.075" PITCH

PLASTIC SHELL

- Board straight connector for flexible and rigid printed circuit boards.
- Operating temperature: 150°C or 200°C.
- Several tail lengths available.

IDENTIFICATION CODE



SERIES

MDA: Micro-D AXON' standard series.

SHELL TYPE

- P:** LCP shell + potting 150°C.
- L:** LCP shell + potting 200°C.

NUMBER OF CONTACTS

09, 15, 21, 25, 31, 37, 51.

See pages 26 & 27 for contact arrangements.

CONNECTOR GENDER

- P:** Male (pin contacts).
- S:** Female (socket contacts).

PCB VERSION

- 75SA:** 0.075" pitch board straight MIL standard layout.
- 75SB:** 0.075" pitch board straight specific layout.

HARDWARE

- B:** No hardware.
 - P:** Jackposts.
 - Px** (x: 1 to 5): Panel mount jackposts.
 - T:** Threaded inserts installed.
 - W:** Jackposts and threaded inserts installed.
 - Wx** (x: 1 to 5): Panel mount jackposts and threaded inserts installed.
- See pages 190 to 200 for hardware description.*

CONDUCTOR TYPE

- G:** Gold plated solid conductor AWG 25.
 - T:** Tin plated solid conductor AWG 24.
- See page 29 for conductor types.*

TAIL LENGTH

- 1:** 2.80 mm (0.110").
- 2:** 3.80 mm (0.150").
- 3:** 4.80 mm (0.190").
- 4:** 6.35 mm (0.250").
- 5:** 3.25 mm (0.127").
- 6:** 3.56 mm (0.140").
- 7:** 4.37 mm (0.172").

Tolerance: ± 0.38 mm (0.015").
Other lengths available on request.

DIMENSIONS

Dimensions are in millimetres (inches).

FEMALE connector

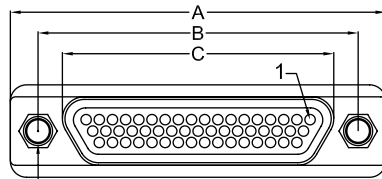

9- 51 contacts:
Ø2.24/2.44 (.088/.096) or THD insert 2-56 UNC 2B

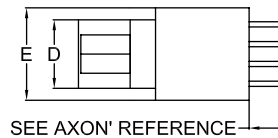

SEE AXON' REFERENCE

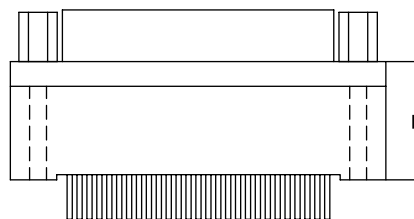

SEE CONTACT LAYOUT ON PCB PAGES 120 TO 125

	A max.	B ± 0.13 (±.005)	C max.		D max.		E max.	F max.
			Male	Female	Male	Female		
9 P / 9 S	19.94 .785	14.35 .565	7.41 .292	9.65 .380	3.40 .134	5.53 .218	7.87 .310	9.07 .357
15 P / 15 S	23.75 .935	18.16 .715	11.22 .442	13.46 .530	3.40 .134	5.53 .218	7.87 .310	9.07 .357
21 P / 21 S	27.56 1.085	21.97 .865	15.03 .592	17.27 .680	3.40 .134	5.53 .218	7.87 .310	9.07 .357
25 P / 25 S	30.10 1.185	24.51 .965	17.57 .692	19.81 .780	3.40 .134	5.53 .218	7.87 .310	9.07 .357
31 P / 31 S	33.91 1.335	28.32 1.115	21.38 .842	23.62 .930	3.40 .134	5.53 .218	7.87 .310	9.07 .357
37 P / 37 S	37.72 1.485	32.13 1.265	25.19 .992	27.43 1.080	3.40 .134	5.53 .218	7.87 .310	9.07 .357
51 P / 51 S	36.45 1.435	30.86 1.215	23.92 .942	26.16 1.030	4.50 .177	6.60 .260	10.16 .400	9.07 .357

SUMMARY OF CHARACTERISTICS

ELECTRICAL & MECHANICAL PERFORMANCE	
CURRENT RATING	3 A max.
CONTACT RESISTANCE	8 mΩ max.
INSULATION RESISTANCE	5000 MΩ min. @ 500 Vdc
DIELECTRIC WITHSTANDING VOLTAGE	Sea level: 600 Vac Altitude 21 km (70,000 ft): 150 Vac
CONTACT ENGAGING FORCE	170 g max. (6 oz)
CONTACT SEPARATING FORCE	14 g min. (0.5 oz)
CONTACT RETENTION	2.26 kg (5 lbs)
DURABILITY	500 mating cycles min.
VIBRATION	20g's – No discontinuity > 1 μs
SHOCK	50g's – No discontinuity > 1 μs

MATERIAL & FINISH	
MOULDED SHELL	Liquid Crystal Polymer (LCP)
PIN CONTACT	Copper and beryllium copper, Gold over nickel plating
SOCKET CONTACT	Copper alloy, gold over nickel plating
ENCAPSULANT	Epoxy resin
MOULDED TRAY	Liquid Crystal Polymer (LCP)
PCB TERMINALS	See ordering info for PCB terminals material
HARDWARE	300 series stainless steel, passivated

SEE PAGE 24 FOR MORE INFORMATION

PCB LAYOUT FOR BS TYPE - 0.075" PITCH - 75SA MIL STANDARD LAYOUT - MALE CONNECTORS

VIEW A

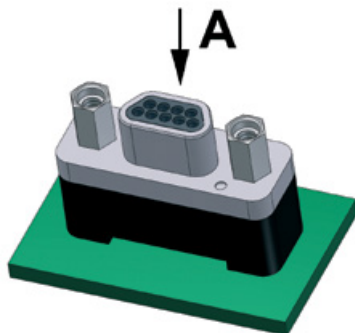
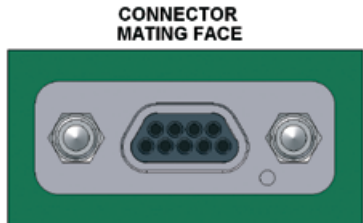

9 CONTACTS - VIEW A

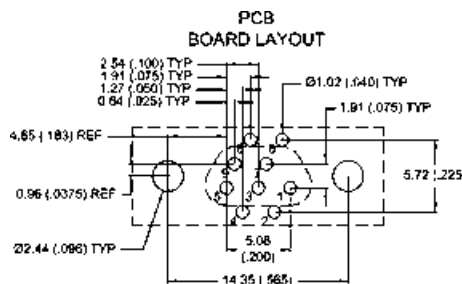

15 CONTACTS - VIEW A

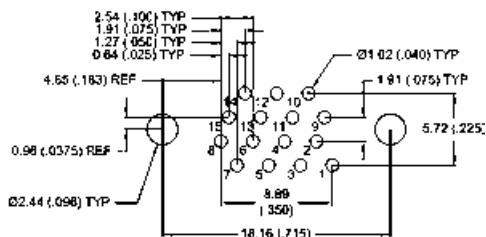

21 CONTACTS - VIEW A

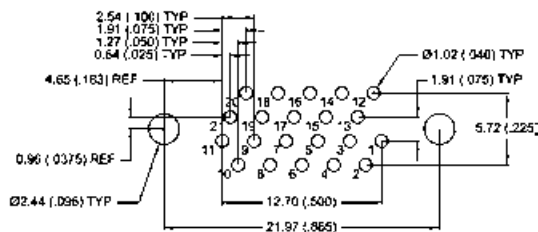

25 CONTACTS - VIEW A

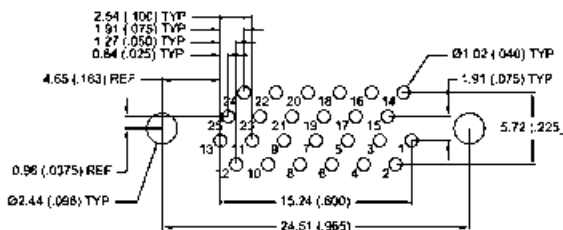

31 CONTACTS - VIEW A

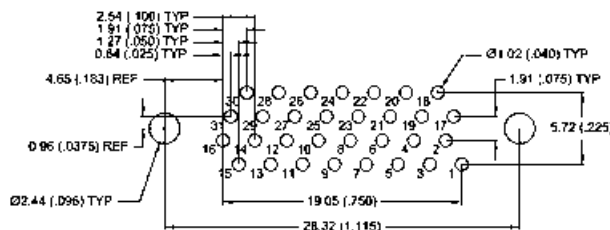

37 CONTACTS - VIEW A

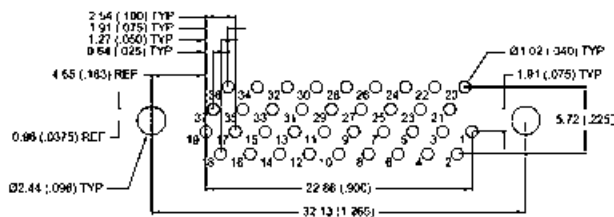

51 CONTACTS - VIEW A

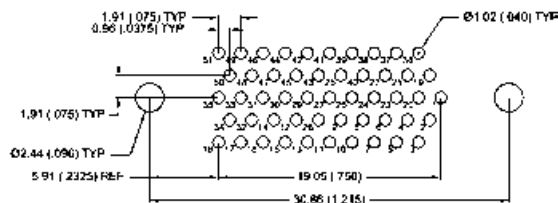

100 CONTACTS - VIEW A

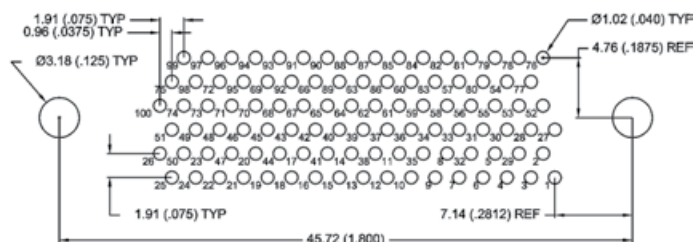

PCB LAYOUT FOR BS TYPE - 0.075" PITCH - 75SA MIL STANDARD LAYOUT - FEMALE CONNECTORS

VIEW A

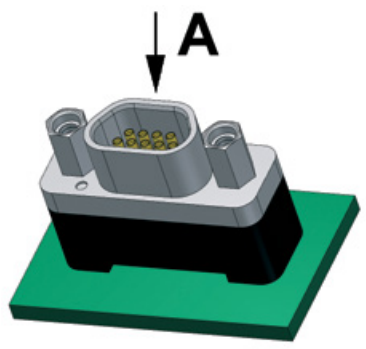

9 CONTACTS - VIEW A

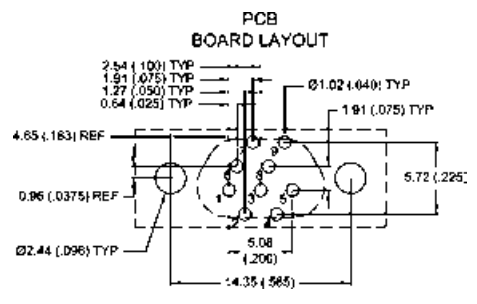

15 CONTACTS - VIEW A

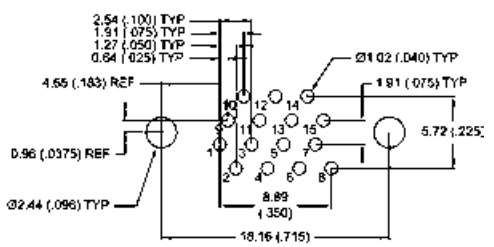

21 CONTACTS - VIEW A

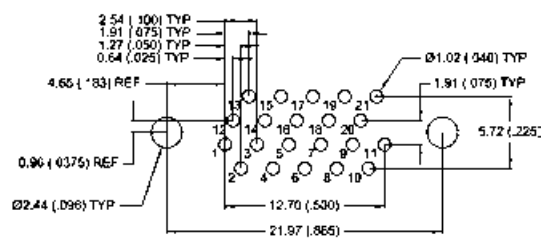

25 CONTACTS - VIEW A

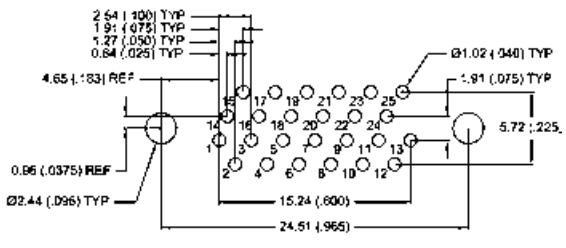

31 CONTACTS - VIEW A

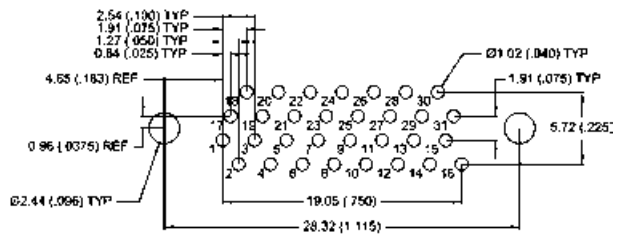

37 CONTACTS - VIEW A

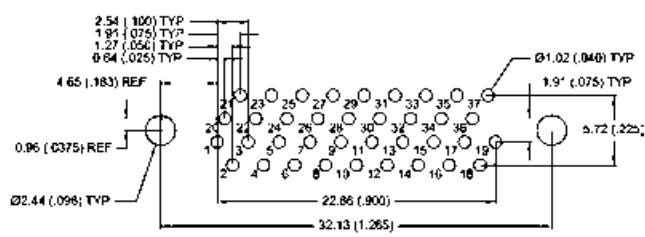

51 CONTACTS - VIEW A

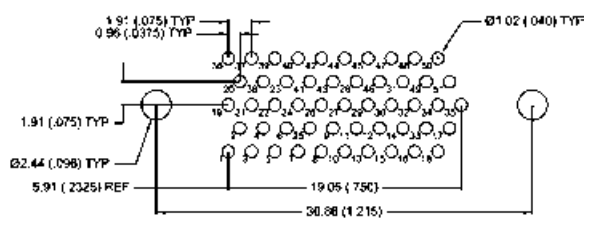

100 CONTACTS - VIEW A

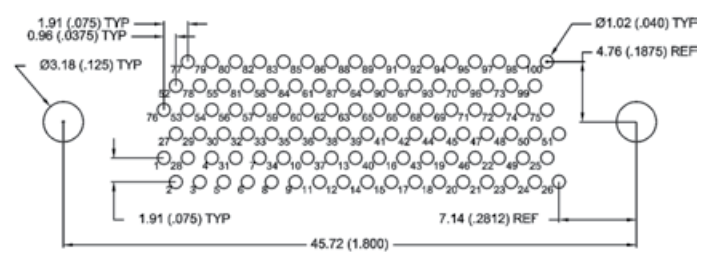

PCB LAYOUT FOR BS TYPE - 0.075" PITCH - 75SB SPECIFIC LAYOUT - MALE CONNECTORS

VIEW A
CONNECTOR
MATING FACE

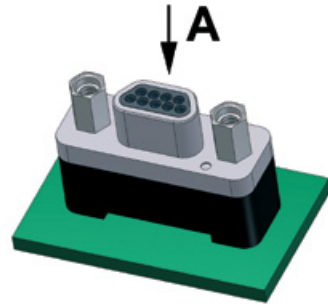
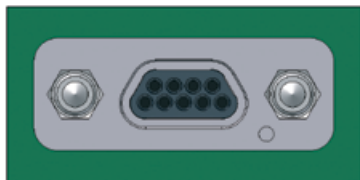

9 CONTACTS - VIEW A

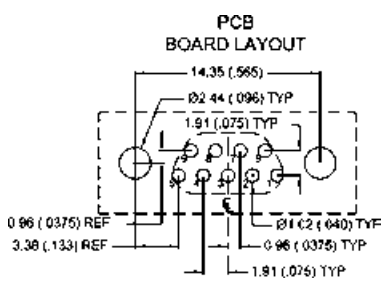

15 CONTACTS - VIEW A

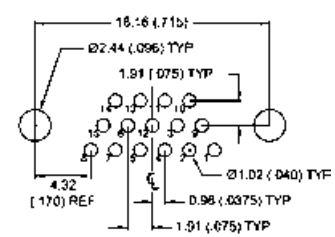

21 CONTACTS - VIEW A

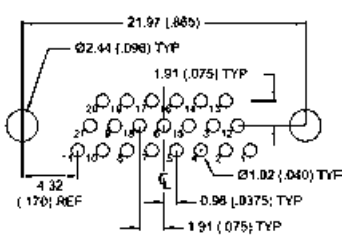

25 CONTACTS - VIEW A

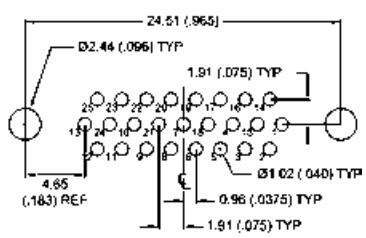

31 CONTACTS - VIEW A

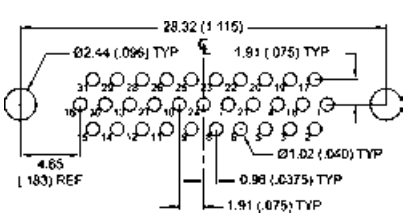

37 CONTACTS - VIEW A

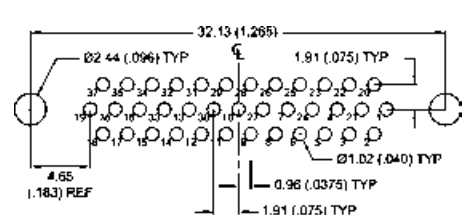

PCB LAYOUT FOR BS TYPE - 0.075" PITCH - 75SB SPECIFIC LAYOUT - MALE CONNECTORS

51 CONTACTS (DOUBLE ROW) - VIEW A

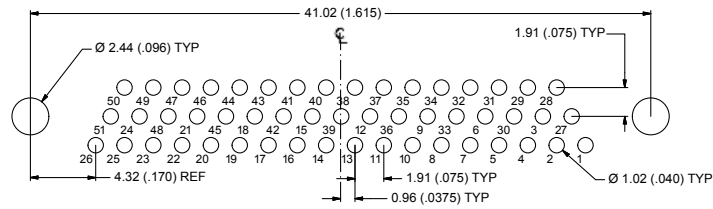

51 CONTACTS - VIEW A

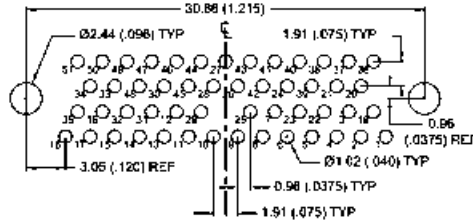

69 CONTACTS - VIEW A

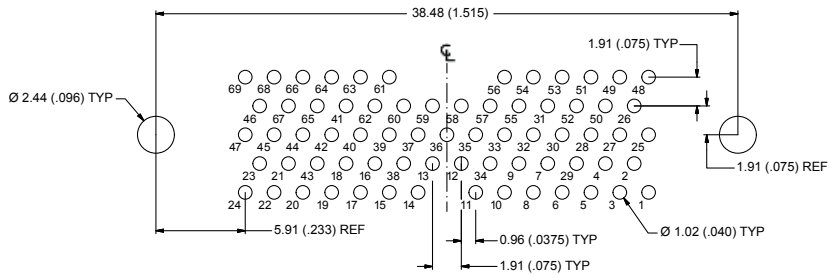

100 CONTACTS - VIEW A

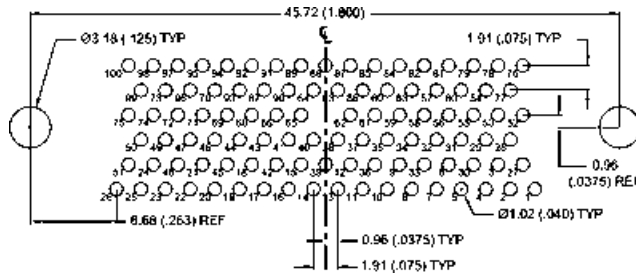

PCB LAYOUT FOR BS TYPE - 0.075" PITCH SPECIFIC LAYOUT - FEMALE CONNECTORS

VIEW A

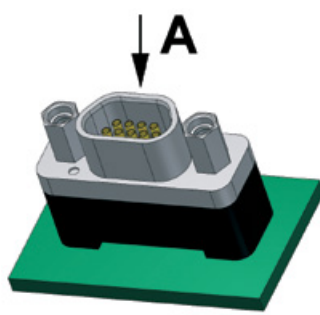

9 CONTACTS - VIEW A

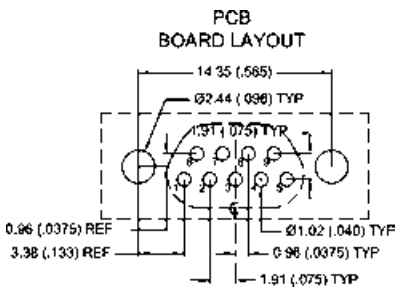

15 CONTACTS - VIEW A

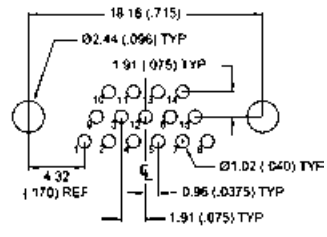

21 CONTACTS - VIEW A

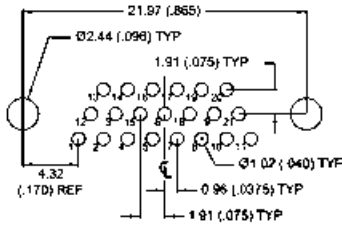

25 CONTACTS - VIEW A

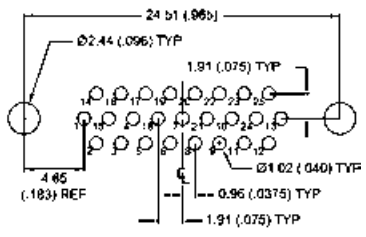

31 CONTACTS - VIEW A

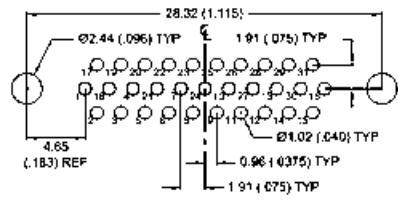

37 CONTACTS - VIEW A

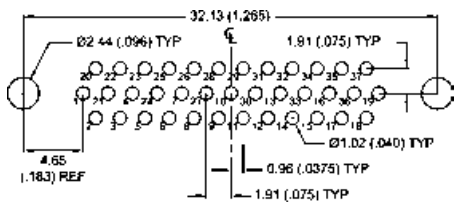

PCB LAYOUT FOR BS TYPE - 0.075" PITCH SPECIFIC LAYOUT - FEMALE CONNECTORS

51 CONTACTS (DOUBLE ROW) - VIEW A

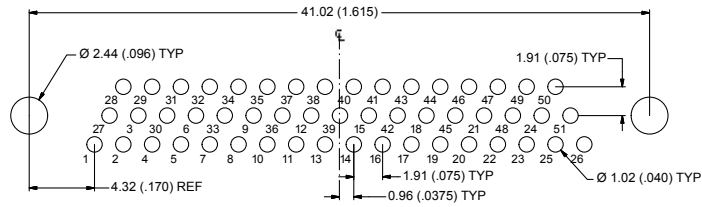

51 CONTACTS - VIEW A

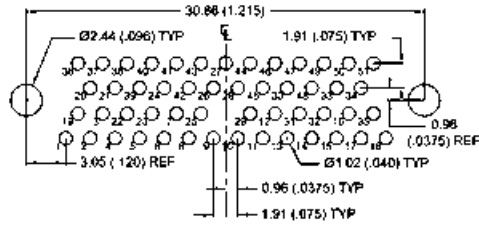

69 CONTACTS - VIEW A

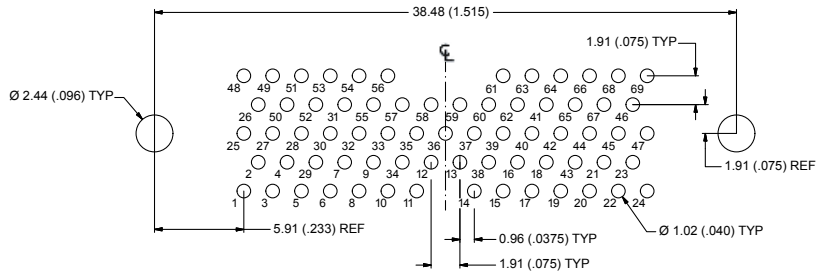

100 CONTACTS - VIEW A

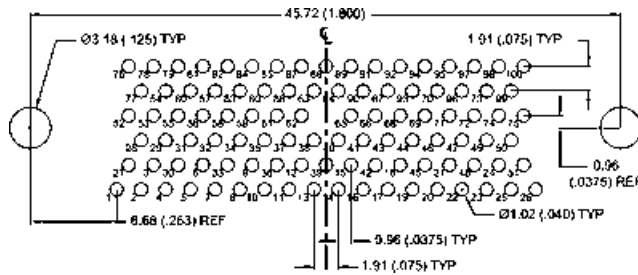

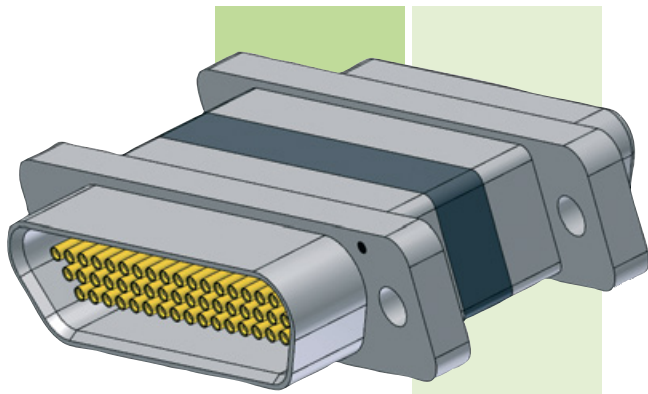

L = 10 (.394)

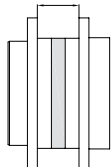

CONNECTOR SAVERS

CONNECTOR SAVER

ONE PIECE DESIGN

METAL OR PLASTIC SHELL

- One piece design version L = 10 mm (.394") between flanges.
- Ideal for applications requiring many mating / demating cycles.
- Reduces wear and tear on systems and test equipment.
- Operating temperature: 150°C or 200°C.

IDENTIFICATION CODE



SERIES

MDA: Micro-D AXON' standard series.

CONNECTOR TYPE

P: LCP shell + potting 150°C.

L: LCP shell + potting 200°C.

1: Cadmium al. shell / **Z:** Black zinc nickel aluminium shell + potting 150°C.

2: Nickel aluminium shell + potting 150°C.

3: Nickel aluminium shell + potting 200°C.

S: Passivated stainless steel shell + potting 200°C.

NUMBER OF CONTACTS

09, 15, 21, 25, 31, 37, 51DR*, 51, 69*, 100*.

*: 51DR, 69 & 100 way only available for 1, 2, 3 & S connector types.

See pages 26 & 27 for contact arrangements.

PRODUCT TYPE

CS: Connector saver (plug to receptacle connector).

ONE PIECE DESIGN ASSEMBLY

1: One piece design assembly.

L = 10 mm (.394").

HARDWARE

B: No hardware.

P1: Removable long jackposts on the female connector.

P2: Removable long jackposts on the male connector.

HARDWARE P1 TYPE

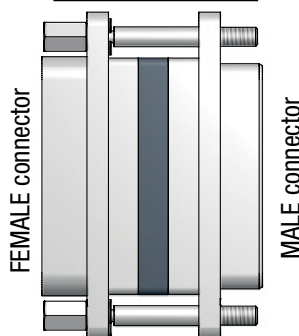

HARDWARE P2 TYPE

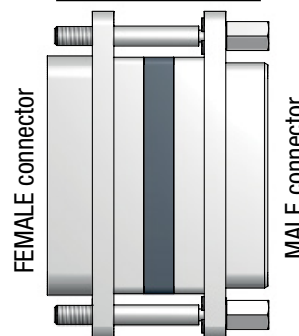

METAL CONNECTORS ARE SUPPLIED WITH ANTI-STATIC PROTECTIVE DUST CAPS

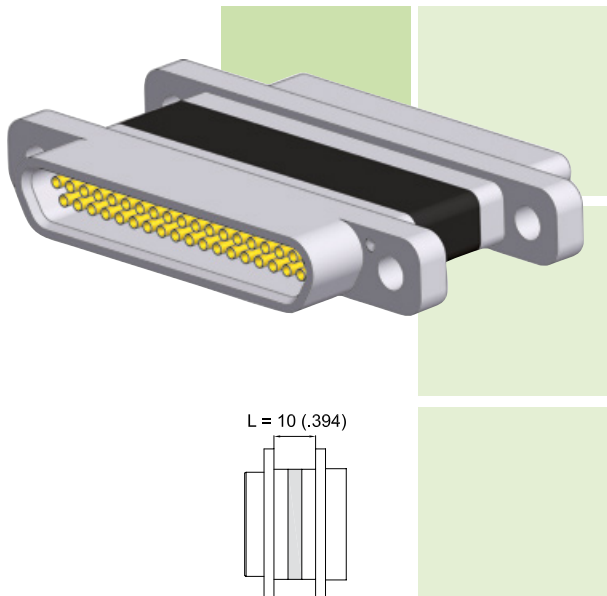

CONNECTOR SAVERS

CONNECTOR SAVER

ONE PIECE DESIGN

LOW PROFILE METAL SHELL

- One piece design version L = 10 mm (.394") between flanges.
- Ideal for applications requiring many mating / demating cycles.
- Reduces wear and tear on systems and test equipment.
- Operating temperature: 150°C or 200°C.

IDENTIFICATION CODE



SERIES

MDA: Micro-D AXON' standard series.

CONNECTOR TYPE

- 1:** Cadmium al. shell / **Z:** Black zinc nickel aluminium shell + potting 150°C.
- 2:** Nickel aluminium shell + potting 150°C.
- 3:** Nickel aluminium shell + potting 200°C.
- S:** Passivated stainless steel shell + potting 200°C.

NUMBER OF CONTACTS

L09, L15, L21, L25, L31, L37, L51.
See pages 26 & 27 for contact arrangements.

PRODUCT TYPE

CS: Connector saver (plug to receptacle connector).

ONE PIECE DESIGN ASSEMBLY

1: One piece design assembly.
L = 10 mm (.394").

HARDWARE

- B:** No hardware
- P1:** Removable long jackposts on the female connector.
- P2:** Removable long jackposts on the male connector.

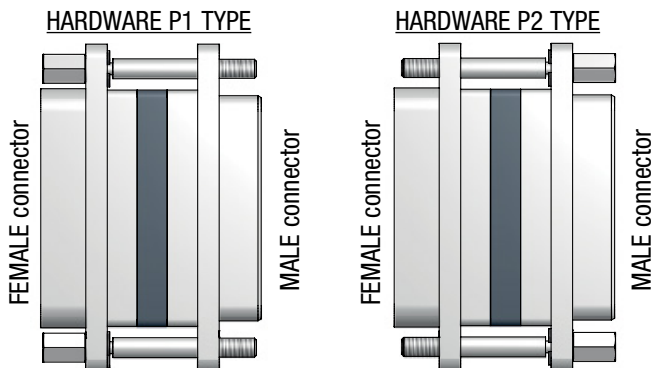

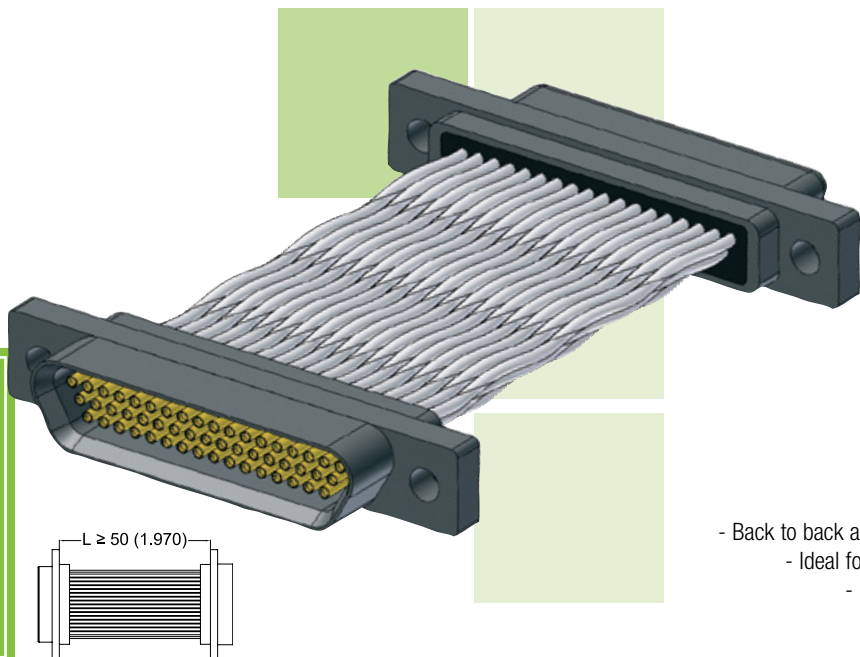

CONNECTOR SAVERS

CONNECTOR SAVER

BACK TO BACK ASSEMBLY

METAL OR PLASTIC SHELL

- Back to back assembly version ($L \geq 50$ mm / 1.970") between flanges
- Ideal for applications requiring many mating / demating cycles.
- Reduces wear and tear on systems and test equipment.
- Operating temperature: 150°C or 200°C.

IDENTIFICATION CODE



SERIES

MDA: Micro-D AXON® standard series.

CONNECTOR TYPE

- 1: Cadmium aluminium shell / Z: Black zinc nickel aluminium shell + potting 150°C.
P: LCP shell + Potting 150°C. **2:** Nickel aluminium shell + Potting 150°C.
L: LCP shell + Potting 200°C. **3:** Nickel aluminium shell + Potting 200°C.
S: Passivated stainless steel shell + Potting 200°C.

NUMBER OF CONTACTS

09, 15, 21, 25, 31, 37, 51DR*, 51, 69*, 100*.
 *: 51DR, 69 & 100 way only available for 1, Z, 2, 3 & S connector types.
 See pages 26 & 27 for contact arrangements.

PRODUCT TYPE

- CS:** Connector saver (receptacle to plug connector).
DP: Dual Pin connector (plug to plug connector).
DS: Dual Socket connector (receptacle to receptacle connector).

BACK TO BACK ASSEMBLY - LENGTH (in cm)

Attention! Wire length in centimetres (1 cm = 10 mm = .394").

L	$5 \leq L \leq 10$	$10 < L \leq 100$	$L > 100$
in cm (inches)	$1.97 \leq L \leq 3.940$	$3.940 < L \leq 39.40$	$L > 39.40$
TOLERANCE	-0 / +0.5	-0 / +3	-0 / +5
in cm (inches)	-0 / +0.200	-0 / +1.180	-0 / +1.970

WIRE TYPE

- 1:** E2607, AWG 26, 7 strands - 600 V. **A:** E2407, AWG24, 7 strands - 600 V.
4: E2619, AWG 26, 19 strands - 600 V. **C:** E 2419, AWG 24, 19 strands - 600 V.
6: E2807, AWG 28, 7 strands - 600 V. **E:** M22759/33, AWG26, 19 strands - 600 V.
8: E3007, AWG 30, 7 strands - 600 V. See page 29 for wire types.

COLOUR CODE

F: All yellow - **L:** all white.

1st CONNECTOR HARDWARE

(for CS 1st connector is the female one).

- B:** No hardware.
C: U-clips with low profile hex.socket head jackscrew (removable).
D: U-clips with low profile slot head jackscrew (removable).
M: low profile hex.socket head jackscrews (removable).
N: high profile hex.socket head jackscrews (removable).
P: Jackposts (removable).
Px (x: 1 to 5): Panel mount jackposts.
S: low profile slot head jackscrews (removable).
T: high profile slot head jackscrews (removable).
 See pages 190 to 200 for hardware description.

2nd CONNECTOR HARDWARE

(for CS 2nd connector is the male one).

See 1st connector hardware for the list of choices.

Other hardware available on request

METAL CONNECTORS ARE SUPPLIED WITH ANTI-STATIC PROTECTIVE DUST CAPS

CONNECTOR SAVERS

CONNECTOR SAVER BACK TO BACK ASSEMBLY

LOW PROFILE METAL SHELL

- Back to back assembly version ($L \geq 50$ mm / 1.970") between flanges.
- Ideal for applications requiring many mating / demating cycles.
- Reduces wear and tear on systems and test equipment.
- Operating temperature: 150°C or 200°C.

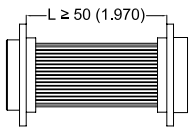
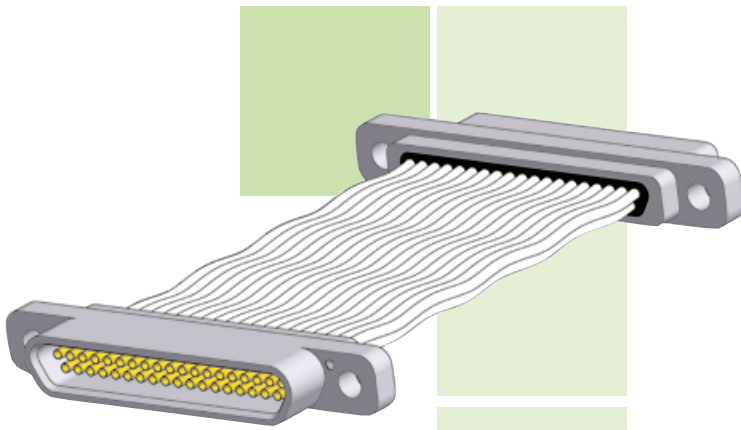

IDENTIFICATION CODE

MDA 2 L51 CS 010 1 L B B

SERIES

MDA: Micro-D AXON' standard series.

CONNECTOR TYPE

- 1:** Cadmium aluminium shell / **Z:** Black zinc nickel aluminium shell + potting 150°C.
- 2:** Nickel aluminium shell + potting 150°C.
- 3:** Nickel aluminium shell + potting 200°C.
- S:** Passivated stainless steel shell + potting 200°C.

NUMBER OF CONTACTS

L09, L15, L21, L25, L31, L37, L51.

See pages 26 & 27 for contact arrangements.

PRODUCT TYPE

- CS:** Connector Saver (receptacle to plug connector).
- DP:** Dual Pin connector (plug to plug connector).
- DS:** Dual Socket connector (receptacle to receptacle connector).

BACK TO BACK ASSEMBLY - LENGTH (in cm)

Attention! Wire length in centimetres (1cm = 10mm = .394").

L	$5 \leq L \leq 10$	$10 < L \leq 100$	$L > 100$
in cm (inches)	$1.97 \leq L \leq 3.940$	$3.940 < L \leq 39.40$	$L > 39.40$
TOLERANCE	-0 / +0.5	-0 / +3	-0 / +5
in cm (inches)	-0 / +0.200	-0 / +1.180	-0 / +1.970

WIRE TYPE

- 1:** E 2607, AWG 26, 7 strands - 600V.
- 4:** E 2619, AWG 26, 19 strands - 600V.
- 6:** E 2807, AWG 28, 7 strands - 600V.
- 8:** E 3007, AWG 30, 7 strands - 600V.
- A:** E 2407, AWG 24, 7 strands - 600V.
- C:** E 2419, AWG 24, 19 strands - 600V.
- E:** M22759/33, AWG 26, 19 strands - 600V.

See page 29 for wire types.

COLOUR CODE

F: All yellow. - **L:** All white.

1st CONNECTOR HARDWARE

(For CS 1st connector is the female one).

- B:** No hardware.
- C:** U-clips with low profile hex socket head jackscrews (removable).
- D:** U-clips with low profile slot head jackscrews (removable).
- M:** Low profile hex socket head jackscrews (removable).
- N:** High profile hex socket head jackscrews (removable).
- P:** Jackposts (removable).
- Px** (x: 1 to 5): Panel mount jackposts.
- S:** Low profile slot head jackscrews (removable).
- T:** High profile slot head jackscrews (removable).

See pages 190 to 200 for hardware description.

2nd CONNECTOR HARDWARE

(For CS 1st connector is the female one).

See 1st connector hardware for the list of choices.

Other hardware available on request

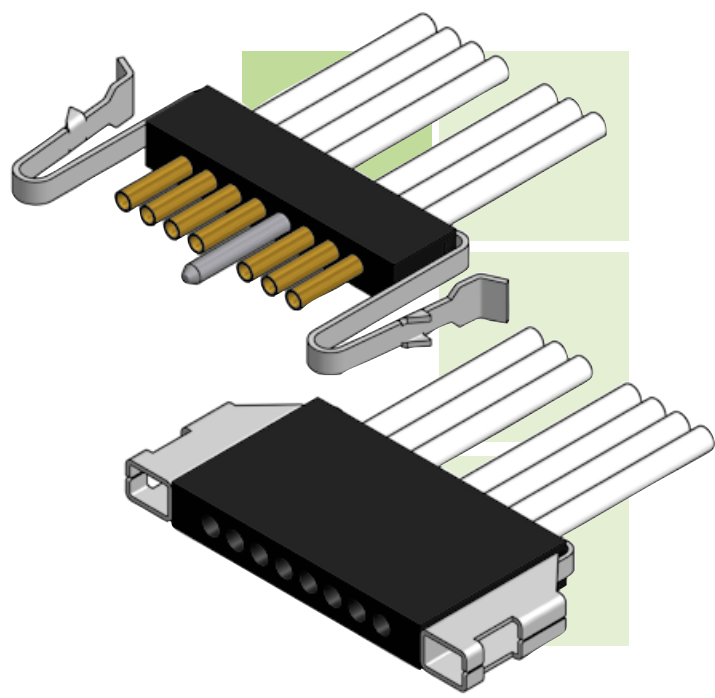

MICROSTRIP CONNECTORS

PIGTAIL & SOLDER CUP ASSEMBLIES

1.27 mm (0.050") PITCH

- Single row plastic connector for space and weight saving applications.
- Guide pin(s) or latch(es) available on female connector (blank cavity(ies) or latch box(es) on male connector).

IDENTIFICATION CODE



SERIES

MSA: Micro Strip AXON® standard series.

STRIP TYPE

P: LCP shell + potting 150°C.
L: LCP shell + potting 200°C.

NUMBER OF ROWS: 1.

NUMBER OF ELECTRICAL CAVITIES: 02 TO 40.

Mechanical cavities are used for polarization, must not be counted here but can reduce the maximum number of available electrical cavities (see page 134).

CONNECTOR GENDER

P: Male (pin contacts).
S: Female (socket contacts).

MOUNTING HOLE OPTION

A: With mounting holes.
B: No mounting holes.

TERMINATION / WIRE TYPE

For colour code V only

3: M22759/11, AWG26. 19 strands, 600V.

F: E2607, AWG26, 7 strands, 600V.

Solid uninsulated wires

G: AWG 25 gold plated.

T: AWG 24 tin plated.

FS: solder cup.

See page 29 for wire types.

COLOUR CODE

F: All yellow.

L: All white.

V: MIL-STD-681 striped (for wire types 3 and F only).

Blank: If wire type is G, T or FS.

W: 10 colour repeat.

See page 30 for colour code.

WIRE LENGTH (in cm)

BLANK: if wire type is FS.

Attention! Wire length in centimetres (1cm = 10 mm = .394").

L	5 ≤ L ≤ 10	10 < L ≤ 100	L > 100
in cm (inches)	1.97 ≤ L ≤ 3.940	3.940 < L ≤ 39.40	L > 39.40
TOLERANCE	-0 / +0.5	-0 / +3	-0 / +5
in cm (inches)	-0 / +0.200	-0 / +1.180	-0 / +1.970

IF NEEDED, YOU CAN COMBINE SEVERAL HARDWARE OPTIONS

- EXAMPLES:
- 2 GUIDE-PINS OR LATCH-SPRINGS AT 2 PARTICULAR POSITIONS: MSAP109SB4L025 **G02 G08 (OR L02 L08)**
 - 1 GUIDE-HOLE CENTERED + 1 LATCH-BOX AT A PARTICULAR POSITION: MSAP112PAR2T3 **GCE L07**
 - 1 GUIDE-PIN CENTERED + LATCH-SPRINGS BOTH ENDS: MSAL117SACF012 **GCE L2E**

ONLY 2 RULES TO BUILD YOUR P/N:

- DEFINE ALL GUIDE PIN CODES FIRST, FOLLOWED BY LATCH CODES
- DEFINE STANDARD CODES (G2E / GCE / L2E / LCE) FIRST, FOLLOWED BY SPECIFIC POSITION CODES (GXX / LXX) AFTERWARDS

POLARIZATION

Blank: None.

G2E: Guide pin / guide hole both ends.

GCE: Guide pin / guide hole centered.

GXX: Guide pin / guide hole in xx position.

L2E: Latch spring / latch box both ends.

LCE: Latch spring / latch box centered.

LXX: Latch spring / latch box in xx position.

DIMENSIONS

Dimensions are in millimetres (inches).

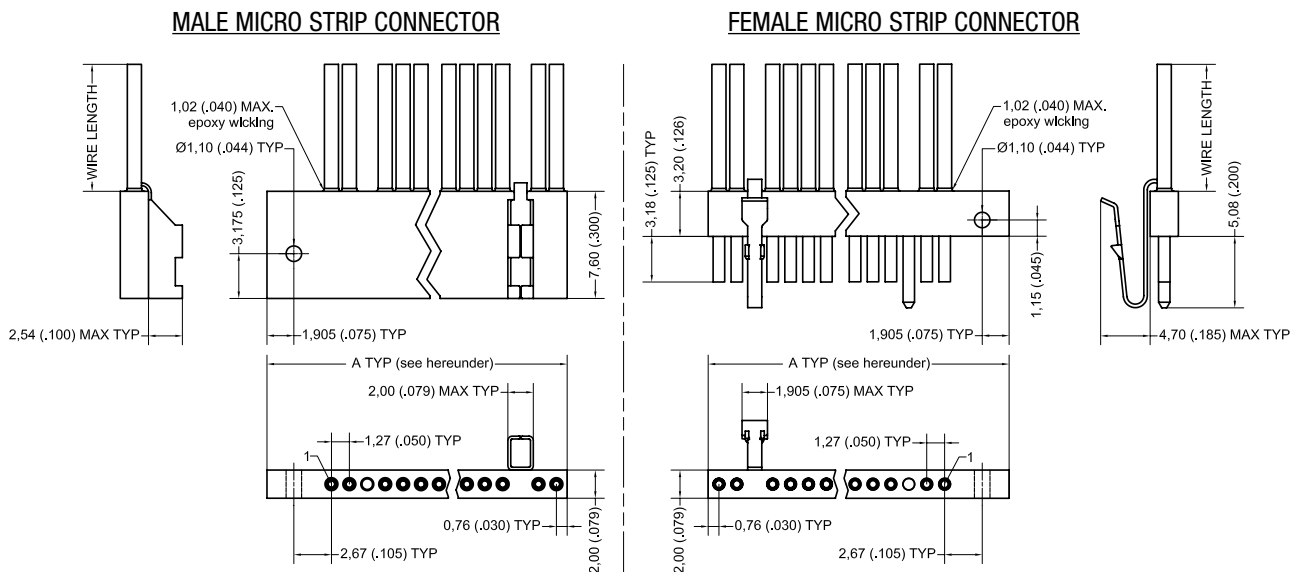

TO DETERMINE CONNECTOR WIDTH A ± 0.3 mm (.012")

	EXAMPLE: 11 CAVITY STRIP WITH MOUNTING HOLES
MULTIPLY the number of mechanical cavities in one row by 1.27 mm (.050")	11 x 1.27 = 13.97
ADD 0.25 mm (.010")	+ 0.25 = 14.22
ADD 7.62 mm (.300") if mounting hole option is selected	+ 7.62 = 21.84

► For detailed information concerning microstrip connectors, see pages 134 to 136.

SUMMARY OF CHARACTERISTICS

ELECTRICAL & MECHANICAL PERFORMANCE	
CURRENT RATING	3 A max.
CONTACT RESISTANCE	8 mΩ max.
INSULATION RESISTANCE	5000 MΩ min. @ 500 V _{DC}
DIELECTRIC WITHSTANDING VOLTAGE	Sea level: 600 V _{AC} Altitude 21 km (70,000 ft): 150 V _{AC}
CONTACT ENGAGING FORCE	170 g max. (6 oz)
CONTACT SEPARATING FORCE	14 g min. (0.5 oz)
CONTACT RETENTION	2.26 kg (5 lbs)
DURABILITY	500 mating cycles min.

MATERIAL & FINISH	
SHELL	Liquid Crystal Polymer (LCP)
PIN CONTACT	Copper and Beryllium copper, gold over nickel plating
SOCKET CONTACT	Copper alloy, gold over nickel plating
ENCAPSULANT	Epoxy resin
GUIDE PIN	300 series stainless steel, passivated
LATCH	Beryllium copper, nickel plating

SEE PAGE 24 FOR MORE INFORMATION

MICROSTRIP CONNECTORS

PCB CONNECTOR

1.27 mm (0.050") PITCH

- Single row plastic connector for space and weight saving applications.
- Guide pin(s) or latch(es) available on female connector (blank cavity(ies) or latch box(es) on male connector).

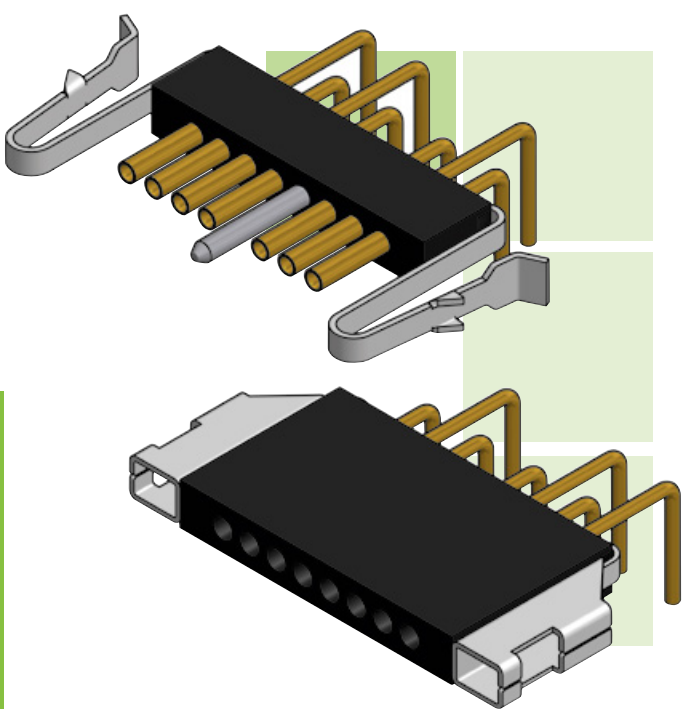

IDENTIFICATION CODE

MSA P 1 07 S B R3 G 2 G06 L2E

SERIES

MSA: Micro Strip AXON® standard series.

STRIP TYPE

P: LCP shell + potting 150°C.
L: LCP shell + potting 200°C.

NUMBER OF ROWS: 1.

NUMBER OF ELECTRICAL CAVITIES: 02 TO 40.

Mechanical cavities are used for polarization, must not be counted here but can reduce the maximum number of available electrical cavities (see page 134).

CONNECTOR GENDER

P: Male (pin contacts).
S: Female (socket contacts).

MOUNTING HOLE OPTION

A: with mounting holes.
B: No mounting holes.

VERSION TYPE

S1: Straight.
S2: Straight, 2.54 mm (0.100") offset.
R1: Right-angle in line.
R2: Right-angle, 1.27 mm (0.050") offset.
R3: Right-angle, 2.54 mm (0.100") offset.

CONDUCTOR TYPE

G: Solid conductor 25 AWG, gold plated.
T: Solid conductor 24 AWG, tin plated.
See page 29 for wire types.

TAIL LENGTH

1: 2.80 mm (0.110").
2: 3.80 mm (0.150").
3: 4.80 mm (0.190").
4: 6.35 mm (0.250").
Tolerance: ± 0.38 mm (0.015").
Other lengths upon request.

POLARIZATION

BLANK: NONE.
G2E: GUIDE PIN / GUIDE HOLE BOTH ENDS.
GCE: GUIDE PIN / GUIDE HOLE CENTERED.
GXX: GUIDE PIN / GUIDE HOLE IN XX POSITION.
L2E: LATCH SPRING / LATCH BOX BOTH ENDS.
LCE: LATCH SPRING / LATCH BOX CENTERED.
LXX: LATCH SPRING / LATCH BOX IN XX POSITION.

IF NEEDED, YOU CAN COMBINE SEVERAL HARDWARE OPTIONS

- EXAMPLES:
- 2 GUIDE-PINS OR LATCH-SPRINGS AT 2 PARTICULAR POSITIONS: MSAP109SB4L025 **G02 G08** (OR **L02 L08**)
 - 1 GUIDE-HOLE CENTERED + 1 LATCH-BOX AT A PARTICULAR POSITION: MSAP112PAR2T3 **GCE L07**
 - 1 GUIDE-PIN CENTERED + LATCH-SPRINGS BOTH ENDS: MSAL117SACF012 **GCE L2E**
- ONLY 2 RULES TO BUILD YOUR P/N:**
- DEFINE ALL GUIDE PIN CODES FIRST, FOLLOWED BY LATCH CODES
 - DEFINE STANDARD CODES (G2E / GCE / L2E / LCE) FIRST, FOLLOWED BY SPECIFIC POSITION CODES (GXX / LXX) AFTERWARDS

DIMENSIONS

Dimensions are in millimetres (inches).

MALE MICRO STRIP CONNECTOR

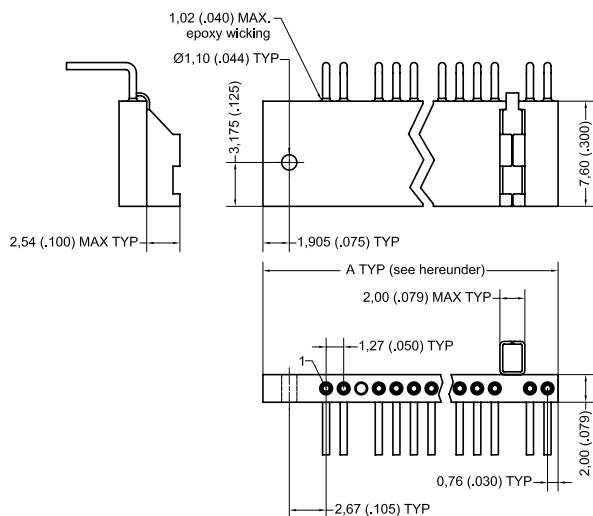

FEMALE MICRO STRIP CONNECTOR

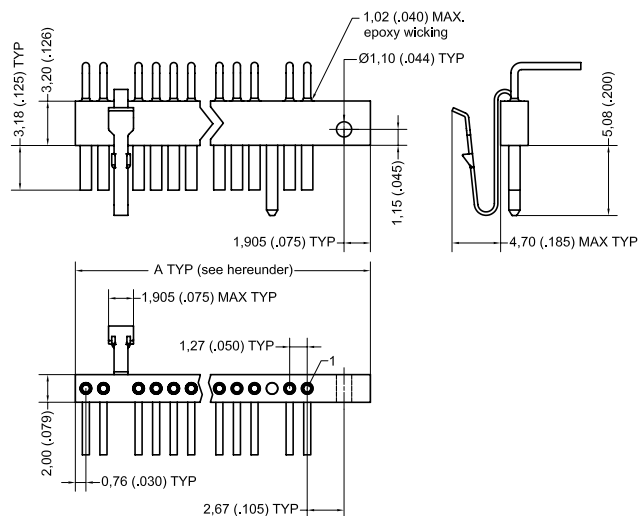

SEE CONTACT LAYOUT ON PCB PAGES 115 / 116 / 117.

TO DETERMINE CONNECTOR WIDTH A ± 0.3 mm (.012")	
	EXAMPLE: 11 CAVITY STRIP WITH MOUNTING HOLES
MULTIPLY the number of mechanical cavities in one row by 1.27 mm (.050")	11 x 1.27 = 13.97
ADD 0.25 mm (.010")	+ 0.25 = 14.22
ADD 7.62 mm (.300") if mounting hole option is selected	+ 7.62 = 21.84

► For detailed information concerning microstrip connectors, see pages 134 to 136.

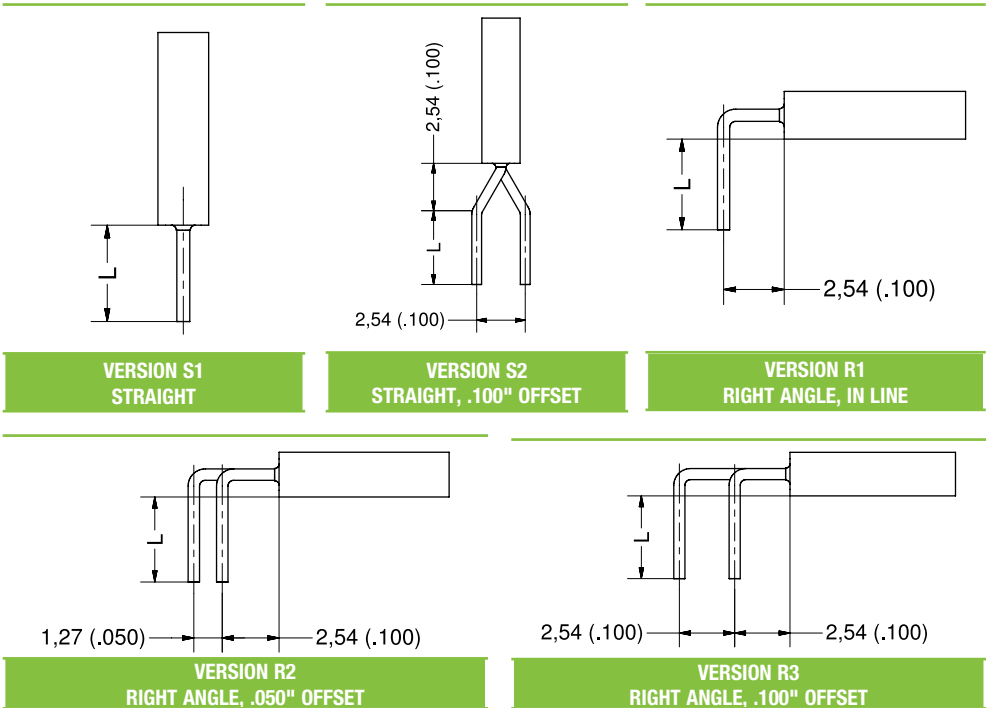



MICROSTRIP GENERAL INFORMATION

► All cavities used, whether for electrical (pin or socket) contacts or for hardware options, (guide pin or latch) are considered as mechanical positions.

- G2E & L2E: 2 mechanical positions to count.
- GCE & LCE: 1 mechanical position to count.
- Gxx & Lxx: 1 mechanical position to count for each occurrence.

NB: If G2E or L2E are chosen, first and last cavities cannot be used for another polarization option (ex: if L2E is chosen, guide pin in position 1 is not possible)

► When specifying the number of ways, only electrical positions (cavities containing pin or socket contacts) are counted.

Example: a 7 way strip with 2 latches at the end and a guide pin would have 10 mechanical positions, but would still be called a 7 way connector.

TO DETERMINE CONNECTOR WIDTH $A \pm 0.3 \text{ mm } (.012\text{'})$	
	EXAMPLE: 11 CAVITY STRIP WITH MOUNTING HOLES
MULTIPLY the number of mechanical cavities in one row by 1.27 mm (.050")	$11 \times 1.27 = 13.97$
ADD 0.25 mm (.010")	$+ 0.25 = 14.22$
ADD 7.62 mm (.300") if mounting hole option is selected	$+ 7.62 = 21.84$

► To determine hardware location number for centered hardware (GCE / LCE):

- Divide the total number of mechanical cavities by two.
- Round to the next whole number if result is a fraction.

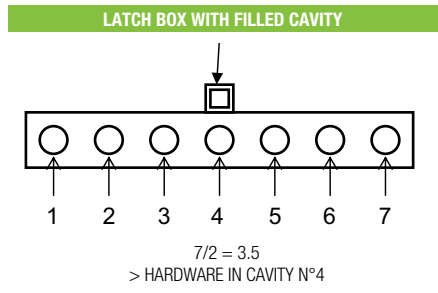
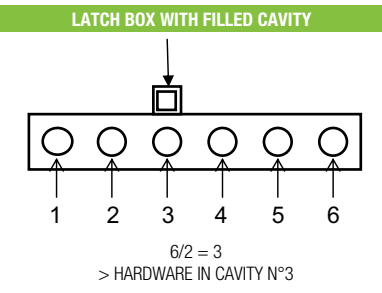

► Hardware options

POLARIZATION BY GUIDE PIN

The guide pin is inserted into the female connector, and there is a guide hole in the opposite cavity in the male connector.

LATCHED RETENTION

The latch spring is mounted on the female connector, with the corresponding latch box installed on the male connector. When the first and/or last mechanical positions are chosen for the latches they will be mounted on the connector edges, making the connector wider but not longer. For all other positions the latches will be mounted on top of the connector, directly above the corresponding mechanical position. Wherever a latch is fitted the corresponding cavity will be filled, and therefore mechanical only in function.

EXAMPLES

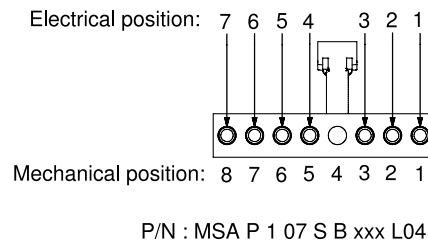
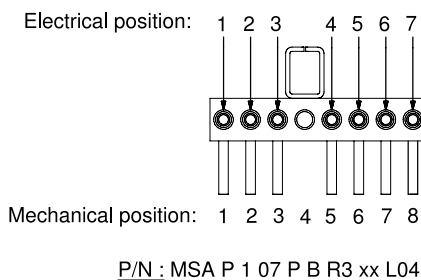
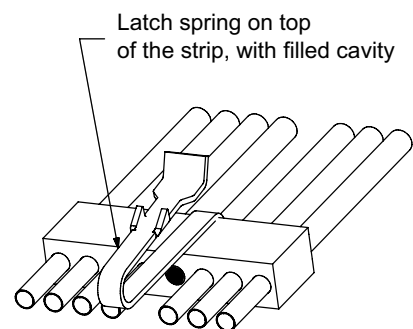
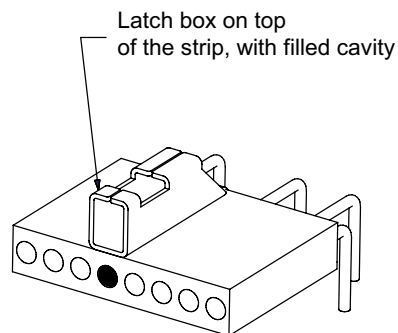
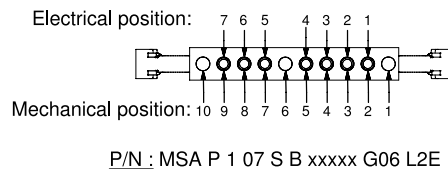
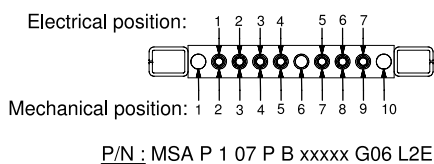
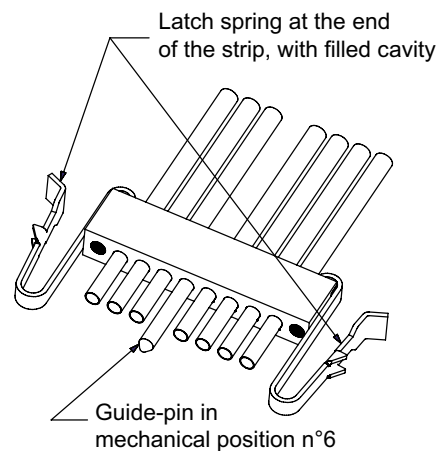
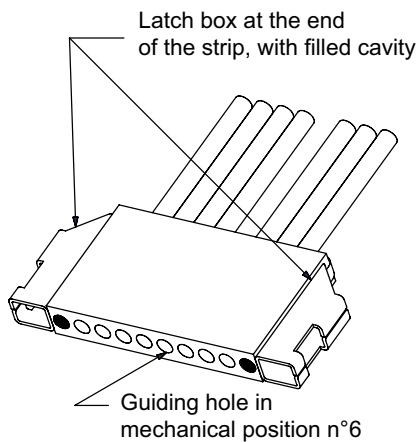

MOUNTING HOLES OPTION

► Position of holes

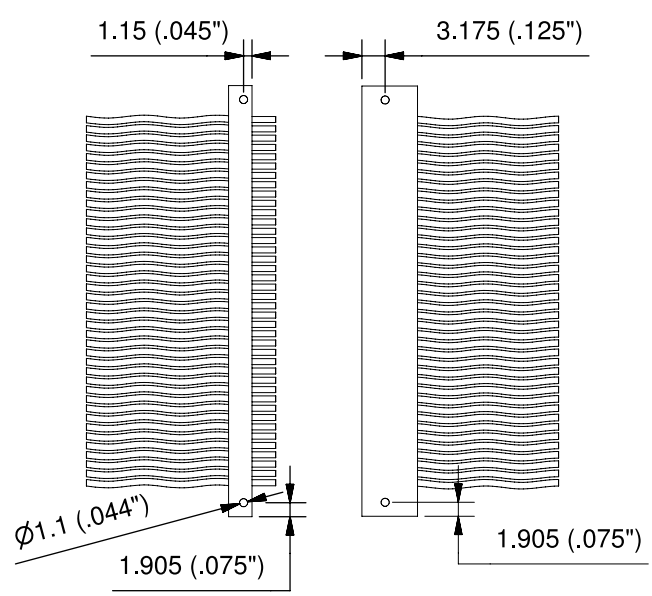

► Special case: mounting holes + hardware

When mounting holes are selected, first and last mechanical cavities are "after the holes area".

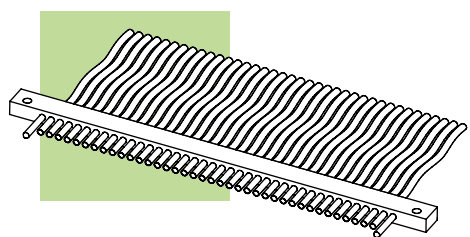
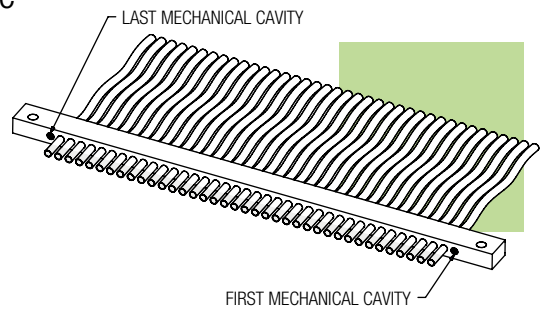

EXAMPLE WITH **GUIDE PIN**

Hardware code G2E

Guide pin / guide holes to be in first and last mechanical cavities.

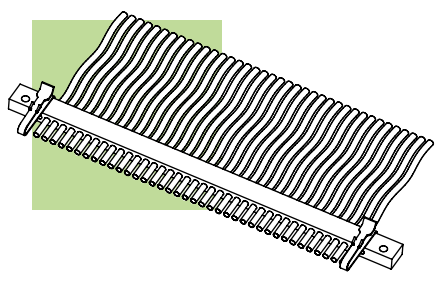

EXAMPLE WITH **LATCHING**

Hardware code L2E

Latch spring / latch box to be above first and last mechanical cavities, not on the edges of the strip.

PCB LAYOUT FOR MICROSTRIP CONNECTORS

VERSION S1: STRAIGHT

EXAMPLE OF A 13 WAY CONNECTOR

MALE MICROSTRIP CONNECTOR

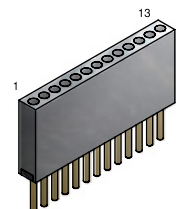
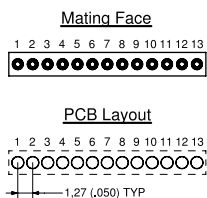

MSA P 1 13 P B S1 G 2

FEMALE MICROSTRIP CONNECTOR

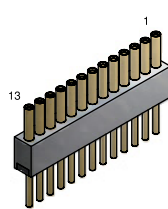
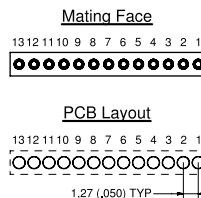

MSA P 1 13 S B S1 G 2

EXAMPLE OF A 10 WAY CONNECTOR WITH GUIDE-PIN, LATCHES AND MOUNTING HOLES

MALE MICROSTRIP CONNECTOR

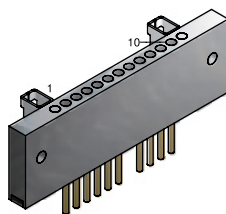
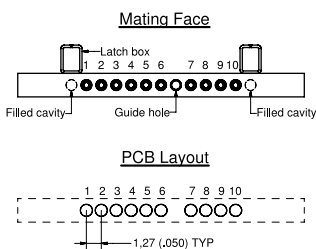

MSA P 1 10 P A S1 G 2 G08 L2E

FEMALE MICROSTRIP CONNECTOR

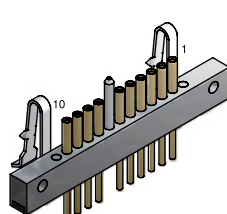
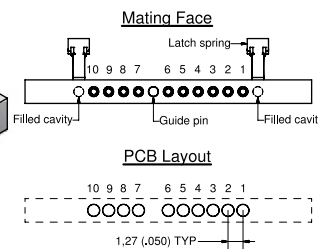

MSA P 1 10 S A S1 G 2 G08 L2E

VERSION S2: STRAIGHT - .100" OFFSET

EXAMPLE OF A 13 WAY CONNECTOR

MALE MICROSTRIP CONNECTOR

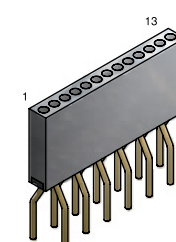
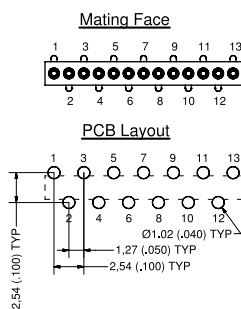

MSA P 1 13 P B S2 G 2

FEMALE MICROSTRIP CONNECTOR

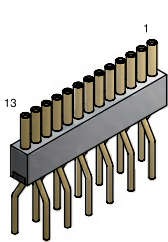
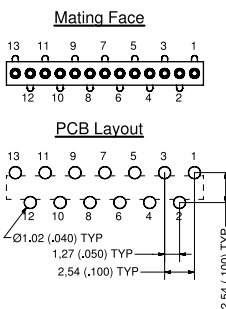

MSA P 1 13 S B S2 G 2

EXAMPLE OF A 10 WAY CONNECTOR WITH GUIDE-PIN, LATCHES AND MOUNTING HOLES

MALE MICROSTRIP CONNECTOR

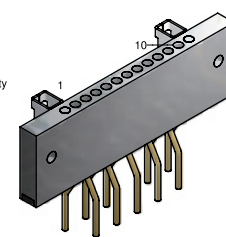
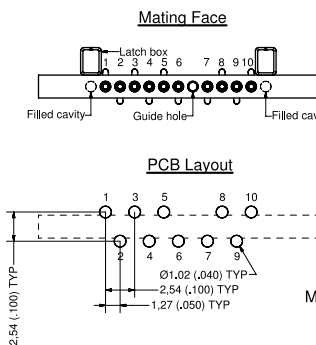

MSA P 1 10 P A S2 G 2 G08 L2E

FEMALE MICROSTRIP CONNECTOR

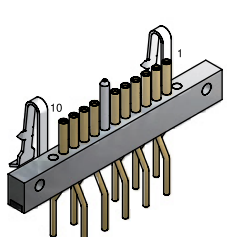
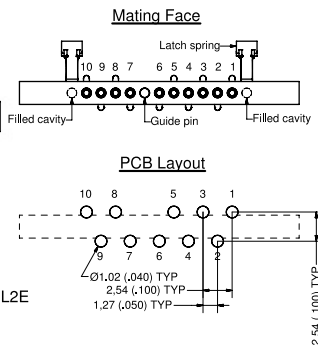

MSA P 1 10 S A S2 G 2 G08 L2E

PCB LAYOUT FOR MICROSTRIP CONNECTORS

VERSION R1: RIGHT ANGLE IN LINE

EXAMPLE OF A 13 WAY CONNECTOR

MALE MICROSTRIP CONNECTOR

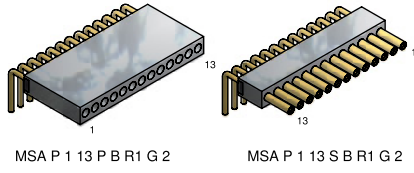
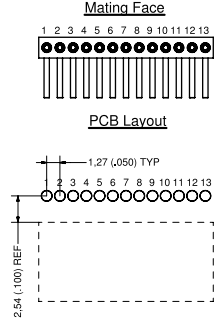

FEMALE MICROSTRIP CONNECTOR

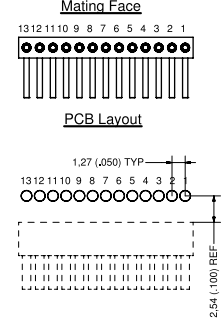

EXAMPLE OF A 10 WAY CONNECTOR WITH GUIDE-PIN, LATCHES AND MOUNTING HOLES

MALE MICROSTRIP CONNECTOR

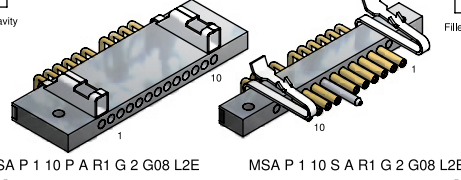
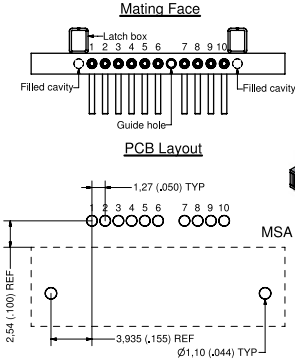

FEMALE MICROSTRIP CONNECTOR

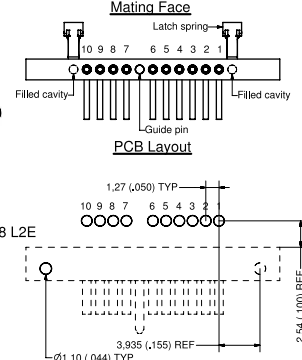

VERSION R2: RIGHT ANGLE, .050" OFFSET

EXAMPLE OF A 13 WAY CONNECTOR

MALE MICROSTRIP CONNECTOR

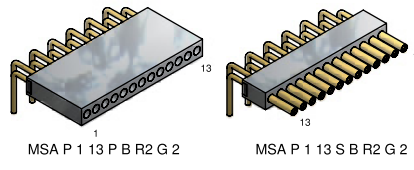
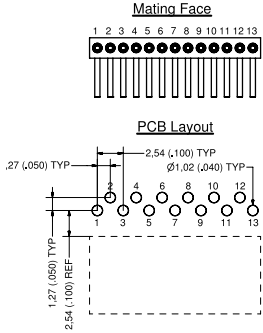

FEMALE MICROSTRIP CONNECTOR

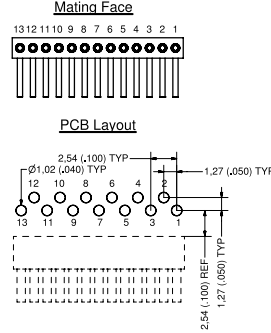

EXAMPLE OF A 10 WAY CONNECTOR WITH GUIDE-PIN, LATCHES AND MOUNTING HOLES

MALE MICROSTRIP CONNECTOR

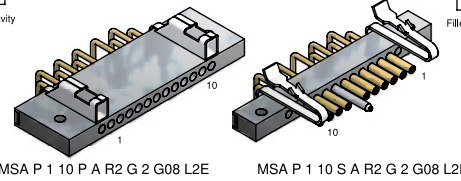
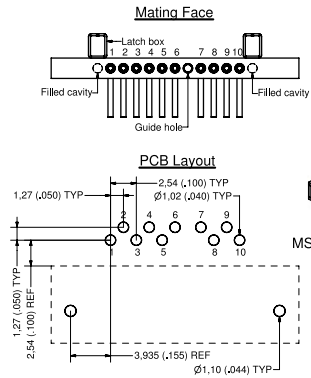

FEMALE MICROSTRIP CONNECTOR

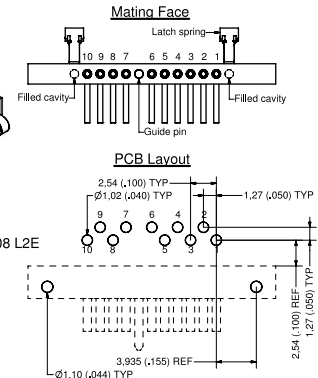

PCB LAYOUT FOR MICROSTRIP CONNECTORS

VERSION R3: RIGHT ANGLE .100" OFFSET

EXAMPLE OF A 13 WAY CONNECTOR

MALE MICROSTRIP CONNECTOR

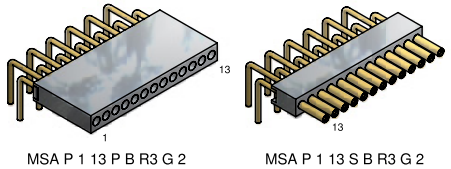
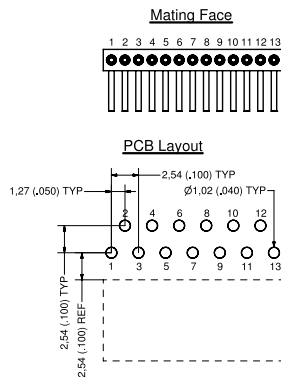

FEMALE MICROSTRIP CONNECTOR

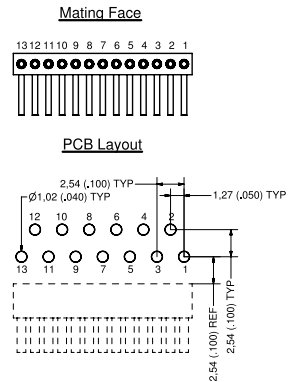

EXAMPLE OF A 10 WAY CONNECTOR WITH GUIDE-PIN, LATCHES AND MOUNTING HOLES

MALE MICROSTRIP CONNECTOR

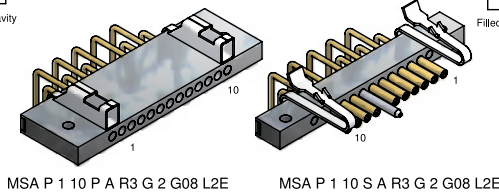
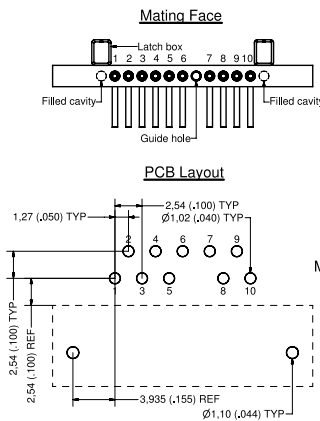

FEMALE MICROSTRIP CONNECTOR

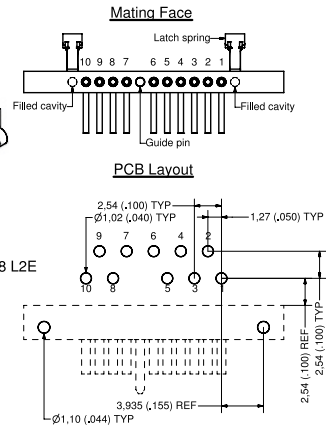

High density
connectors

HIGH DENSITY CONNECTORS

NANO-D PITCH

As the need for increased miniaturisation is becoming even greater, AXON[®] has developed an ultra-high density solution within the existing micro connector size. By putting nano contacts and nano pitch spacing into an existing micro shell, extremely compact connectors with very high pin counts can be produced in circular, rectangular, plastic and metal forms.

Optimal cabling density is achieved in a rectangular ultra high density connector made with Nano-D contacts and spacing inside a standard Micro-D shell size. Such a connector can accommodate a very large amount of pins while retaining excellent Micro-D reliability.

Most electrical and environmental performances are comparable to those of standard Nano-D connectors (250 V_{AC}, 200°C), combined with the robustness and shielding efficiency of the Micro-D metal shell which is compatible with all the hardware types available for Micro-D pigtailed.

This same process can be applied to most of the standard and special Micro-D range, making it possible to have ultra high density versions of PCB connectors, wide flange versions, circular, rectangular and combo style versions with a mix of Micro-D and Nano-D contacts.

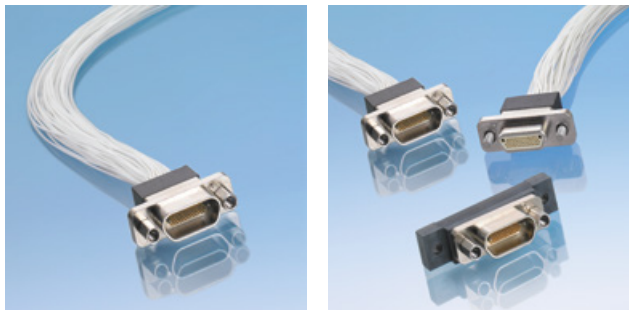

▲ RECTANGULAR HIGH DENSITY MICRO-D CONNECTORS

► High density range

All versions are available with 28, 52 or 86 contacts.
Please find detailed information about this product range in the Nano-D chapter of the catalogue (page 282)

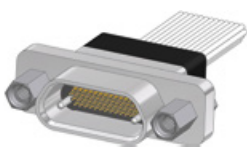

PIGTAILS

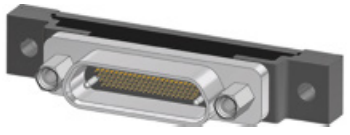

BOARD STRAIGHT TYPE (BS) 0.050" PITCH

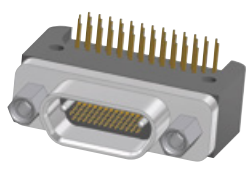

CONDENSED BOARD RIGHT ANGLE TYPE (CBR) 0.050" PITCH

COMBO MICRO-D CONNECTORS

COMBO-D GENERAL INFORMATION

- Rectangular Combo Micro-D connectors 142
- Contact arrangements 143
- Coaxial and power contacts and cables 144
- General characteristics 147

PCB COMBO CONNECTORS

- PCB connectors 148
- Board Straight type (BS) - 0.075" pitch 149
- Condensed Board Right angle (CBR) - 0.100" pitch 153

PIGTAIL COMBO CONNECTORS

- Male and female pigtail connectors 157

SPECIAL COMBO CONNECTORS 160



COMBO-D
CONNECTORS

Rectangular
Micro-D connectors

COMBO Micro-D
connectorsRECTANGULAR COMBO
MICRO-D CONNECTORS

Continuous miniaturisation in electronics makes it ever more challenging to route power and RF signals through very small connectors.

The ideal solution is the AXON® Combo Micro-D. These special, hybrid connectors accommodate a mixture of power and coaxial cables, along with regular signal wires, all in one compact body.

They are available in 2 types and 3 different styles.

► PCB connectors

► BS TYPE

- Board Straight connector for flexible and rigid printed circuit boards,
- Various tail lengths available.



► CBR TYPE

- Condensed Board Right angle connector for flexible and rigid printed circuit boards,
- Various tail lengths available.

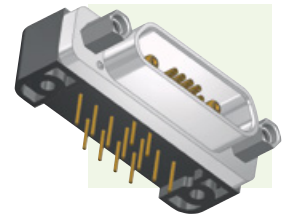

► Pigtail connectors

- With coaxial cables (different types and sizes available)
- Connectors are backpotted to protect contacts
- A mixed arrangement with coaxial and power cables is also possible.

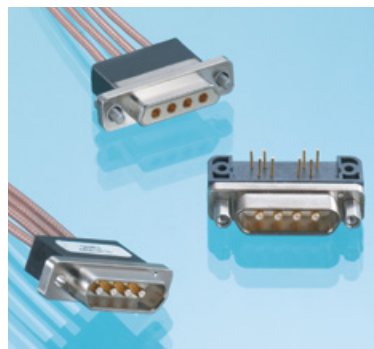
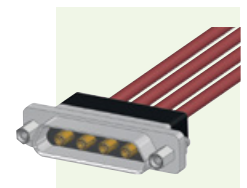

▲ COMBO MICRO-D
WITH Ø2.2MM CONTACT

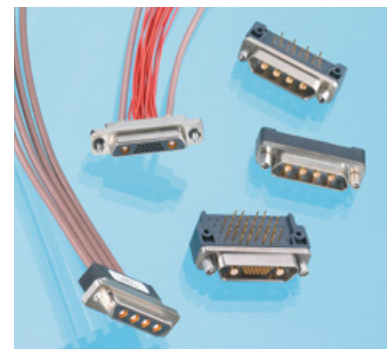

▲ COMBO MICRO-D WITH
Ø3MM CONTACT

CONTACT ARRANGEMENTS

Combo Micro-D connectors use two types of contacts in two sizes:

- 2.2 mm and 3 mm diameter coaxial contacts.
- 2.2 mm and 3 mm diameter power contacts.

Arrangements can vary depending on the number and the size of the coaxial, power and signal contacts.

AXON' standard combo Micro-D connectors are available with four different mating faces.

▶ MATING FACE VIEW

MALE MATING FACE

FEMALE MATING FACE

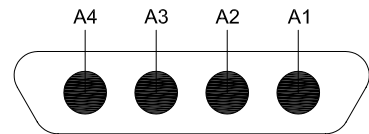
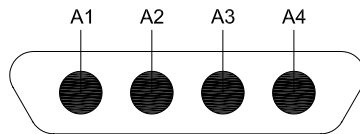

C1/P1: 4 CONTACTS Ø3MM IN A 51 WAY MICRO-D SHELL

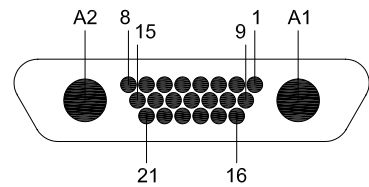
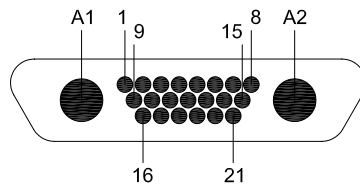

C3/P3: 2 CONTACTS Ø3MM + 21 SIGNALS IN A 51 WAY MICRO-D SHELL

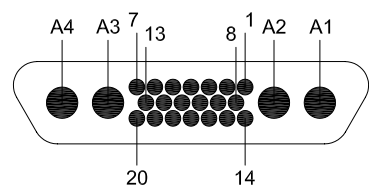
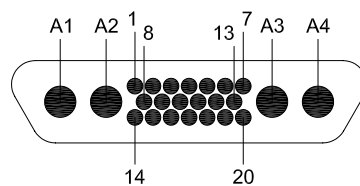

C10/P10: 4 CONTACTS Ø2.2MM + 20 SIGNALS IN A 51 WAY MICRO-D SHELL

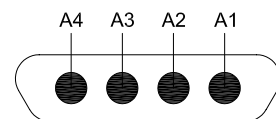
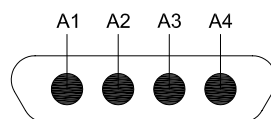

C8/P8: 4 CONTACTS Ø2.2MM IN A 25 WAY MICRO-D SHELL

COMBO Micro-D
connectorsCOAXIAL & POWER CONTACTS
& CABLES

AXON' uses micro-miniature high frequency and high power contacts to provide the optimum performance within the smallest available space. Two contacts sizes are available: 2.2 mm and 3.0 mm.

AXON' also offers coaxial contacts in 2 different impedances - 50Ω and 75Ω - and power contacts in different current ratings, from 5A to 20A.

Their characteristics are detailed below:

COAXIAL CONTACTS					
CONTACT TYPE mm (inch)	MEDIA	CONTACT IMPEDANCE	INSULATION RESISTANCE (contacts only)	SWR (contacts only) (Standing Wave Ratio)	FREQUENCY (max.) (for the final assembly)
Ø 3.00 0.118	PCB	50 Ω AND 75 Ω	10 ⁶ MΩ / 250 V _{RMS} (*)	< 1.05 + 0.04 F (GHz) (*)	3 GHz
Ø 3.00 0.118	Coaxial cable	50 Ω AND 75 Ω	10 ⁶ MΩ / 250 V _{RMS}	< 1.05 + 0.04 F (GHz)	6 GHz (depending on cable)
Ø 2.20 0.086	PCB	50 Ω	10 ⁶ MΩ / 250 V _{RMS} (*)	< 1.05 + 0.04 F (GHz) (*)	1 GHz
Ø 2.20 0.086 (*)	Coaxial cable	50 Ω	10 ⁶ MΩ / 250 V _{RMS}	< 1.05 + 0.04 F (GHz)	3 GHz (depending on cable)

(*)The above values depend on the impedance of the PCB the connector is connected to.

POWER CONTACTS			
CONTACT TYPE mm (inch)	AWG	CONTACT RESISTANCE	CURRENT (max.)
Ø 3.00 0.118	20	6 mΩ max.	5A
	18	6 mΩ max.	8A
	16	6 mΩ max.	10A
	14	6 mΩ max.	15A
	12	6 mΩ max.	20A
Ø 2.20 0.086	20	6 mΩ max.	5A
	18	6 mΩ max.	8A
	16	6 mΩ max.	10A

► Coaxial cable specification

CONTACT DIAMETER mm (inch)	IMPEDANCE	COAXIAL CABLE AVAILABLE	NOMINAL DIAMETER mm (inch)	AXON' P/N
Ø3.00 0.118	50 Ω	AX086 RG316	2.50 .098 2.59 .102	P531437 RG316
	75 Ω	RG179	2.66 .105	RG179
Ø2.20 0.086	50 Ω	AX047 RG178	1.50 .059 1.90 .075	P535846 RG178

► AX047 and AX086 coaxial cable specification

► CABLE CONSTRUCTION

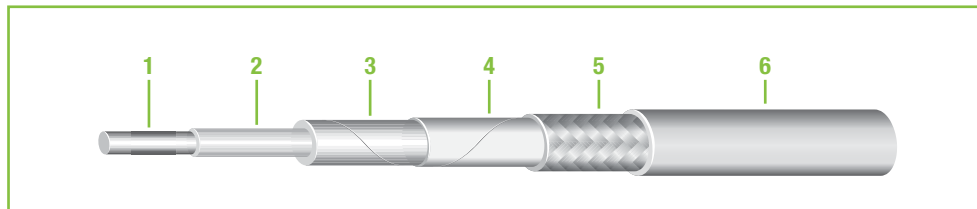

	1 - CONDUCTOR		2 - DIELECTRIC		3 - SHIELDING	4 - TAPE	5 - SHIELDING		6 - JACKET	
VERSION	MATERIAL	∅ mm (inch)	MATERIAL	∅ mm (inch)	MATERIAL	MATERIAL	MATERIAL	∅ mm (inch)	MATERIAL	∅ mm (inch)
AX047	SPC*	0.25 .010	PTFE	0.82 .033	SPC* TAPE	POLYESTER	SPC* BRAID	1.17 .046	FEP	1.50 .059
AX086	SPC*	0.51 .020	PTFE	1.66 .065	SPC* TAPE	POLYESTER	SPC* BRAID	2.17 .085	FEP	2.50 .098

* Silver Plated Copper

► ELECTRICAL CHARACTERISTICS

	AX047	AX086
IMPEDANCE (ohms)	50 ± 2	50 ± 1
CAPACITANCE (pF/m)	97	97
INSERTION LOSS @ 23°C @ 18 GHz (dB/m)	6.6	3.45

► ELECTRICAL CHARACTERISTICS OF A PIGTAIL WITH COAXIAL CONTACT SIZE 3.0 MM

The performances mentioned in the following table have been obtained with the configuration below.

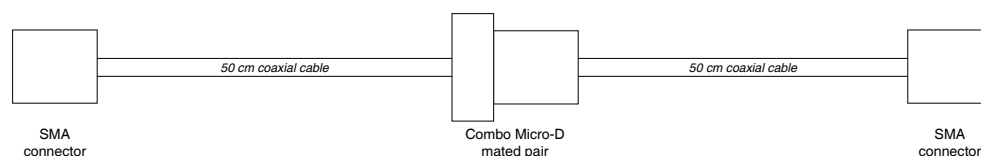

	COMBO WITH S3 CONTACTS AND RG316	COMBO WITH S3 CONTACTS AND AX086
Max. VSWR DC-6 GHz	1.40	1.35
Max. attenuation at 1 GHz (dB)	1.04	0.87
Max. attenuation at 2 GHz (dB)	1.52	1.25
Max. attenuation at 4 GHz (dB)	2.26	1.80
Max. attenuation at 6 GHz (dB)	2.88	2.24

► RGxxx coaxial cable specification

► CABLE CONSTRUCTION

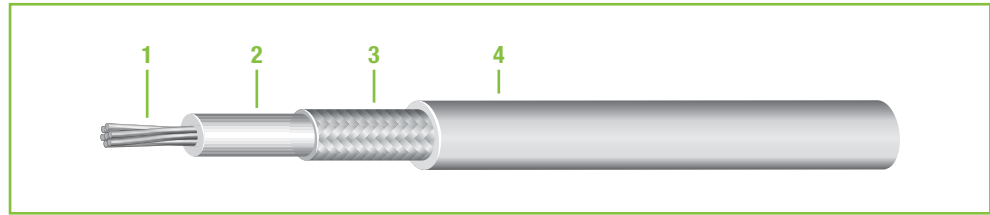

VERSION	1 - CONDUCTOR		2 - DIELECTRIC		3 - SHIELDING		4 - JACKET		IMPEDANCE (Ohms)
	MATERIAL	Ø mm (inch)	MATERIAL	Ø mm (inch)	MATERIAL	Ø mm (inch)	MATERIAL	Ø mm (inch)	
RG178	SPC*	0.30 .0118	PTFE	0.85 .033	SPC* Braid	1.30 .051	FEP	1.90 .0354	50
RG179	SPC*	0.30 .0118	PTFE	1.60 .063	SPC* Braid	2.05 .080	FEP	2.66 .105	75
RG316	SPC*	0.51 .02	PTFE	1.06 .042	SPC* Braid	1.97 .076	FEP	2.59 .102	50

*: Silver Plated Copper

► Power cable specification

For pigtails with power contacts, we recommend PTFE-insulated wire AXON' reference Exx19, xx being the AWG of the wire.

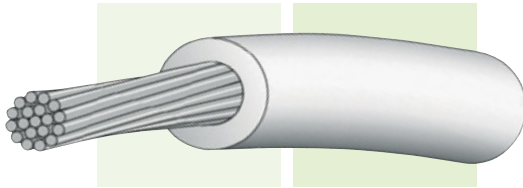

WIRE DESIGNATION	CONDUCTOR						INSULATION		TEMPERATURE RATING	VOLTAGE RATING
	MATERIAL	AWG	CONSTRUCTION mm (inch)	Ø mm (inch)	AREA mm ² (SQ IN)	RESISTANCE Ω/100M (Ω/1000FT)	MATERIAL	Ø mm (inch)		
E1219	SPC*	12	19x0.455 19x.018	2.273 .09	3.10 .0048	0.58 1.77	EXTRUDED PTFE	2.85 .112	-90°C / +200°C	600 V _{AC}
E1419	SPC*	14	19x0.360 19x.014	1.803 .07	1.94 .00300	0.92 2.8	EXTRUDED PTFE	2.35 .0925	-90°C / +200°C	600 V _{AC}
E1619	SPC*	16	19x0.300 19x.012	1.500 .06	1.34 .00207	1.3 3.96	EXTRUDED PTFE	2.1 .083	-90°C / +200°C	600 V _{AC}
E1819	SPC*	18	19x0.254 19x.010	1.269 .05	0.96 .0015	1.9 5.9	EXTRUDED PTFE	1.75 .070	-90°C / +200°C	600 V _{AC}
E2019	SPC*	20	19x0.203 19x.008	1.009 .04	0.62 .00096	2.9 8.84	EXTRUDED PTFE	1.50 .060	-90°C / +200°C	600 V _{AC}

*: Silver Plated Copper

GENERAL CHARACTERISTICS

▶ Electrical & mechanical characteristics

CHARACTERISTICS	SPECIFICATION	TEST METHOD
SIGNAL CONTACT CURRENT RATING	3 A max.	EIA-364-70
SIGNAL CONTACT RESISTANCE	8 mΩ max.	EIA-364-06
INSULATION RESISTANCE	5000 MΩ min. @ 500 Vdc	EIA-364-21
DIELECTRIC WITHSTANDING VOLTAGE - SEA LEVEL 0 m - ALTITUDE 21 km (70,000 ft)	600 V _{ac} 150 V _{ac}	EIA-364-20
VSWR	Depending on contact and coaxial cable	
INSERTION LOSS	Depending on contact and coaxial cable	
CONTACT ENGAGING AND SEPARATION FORCE (SIGNAL LINES)	170 g max. (6 oz) 14 g min. (0.5 oz)	EIA-364-37
CONTACT RETENTION (SIGNAL LINES)	2.26 kg (5 lbs) for 5 seconds min.	EIA-364-29
DURABILITY	500 mating cycles min.	EIA-364-09
TEMPERATURE RANGES - WITH COAXIAL CONTACTS - WITH POWER CONTACTS	- 55°C / +125°C - 55°C / +150°C	
VIBRATION	20 g's - No discontinuity >1μs	EIA-364-28 -TEST CONDITION IV
SHOCK	50 g's - No discontinuity >1μs	EIA-364-27 -TEST CONDITION E
SALT SPRAY	48 hours	EIA-364-26 -TEST CONDITION B
HUMIDITY	Insulation resistance > 1MΩ	EIA-364-31 - METHOD IV

▶ Material & Finish

COMPONENT	MATERIAL	FINISH
SIGNAL CONTACT	MALE CONTACT (TWIST PIN)	COPPER AND BERYLLIUM COPPER
	FEMALE CONTACT	COPPER ALLOY
COAXIAL CONTACT AND POWER CONTACT	SPRING LOADED PARTS	BERYLLIUM COPPER
	OTHER METAL PARTS	COPPER ALLOY
	INSULATOR	PTFE
METAL SHELL	ALUMINIUM ALLOY, TYPE 6061	YELLOW CHROMATE OVER CADMIUM : IN ACCORDANCE WITH SAE-AMS-QQ-P-416, TYPE II, CLASS 3 ELECTROLESS NICKEL PLATING IN ACCORDANCE WITH SAE-AMS2404, CLASS 4, .0005 INCH MIN. BLACK ZINC NICKEL OVER NICKEL UNDERPLATE
	STAINLESS STEEL, 300 SERIES	PASSIVATION IN ACCORDANCE WITH SAE-AMS2700
PLASTIC SHELL / INSERT / PCB TRAY	LIQUID CRYSTAL POLYMER, 30% LOADED GLASS FIBRE POLYESTER, 94VO, IN ACCORDANCE WITH MIL-M-24519 (200°C)	
HARDWARE	STAINLESS STEEL, 300 SERIES	PASSIVATION IN ACCORDANCE WITH SAE-AMS2700
ENCAPSULANT	EPOXY RESIN	
INSULATED WIRE (SIGNAL LINES)	PTFE INSULATED SILVER PLATED COPPER IN ACCORDANCE WITH NEMA-HP3 PTFE INSULATED SILVER PLATED COPPER IN ACCORDANCE WITH SAE-AS22759/11 ETFE INSULATED SILVER PLATED COPPER IN ACCORDANCE WITH SAE-AS22759/33	
UNINSULATED WIRE (SIGNAL LINES)	GOLD PLATED SOLID COPPER WIRE IN ACCORDANCE WITH A-A-59551 TIN PLATED SOLID COPPER WIRE IN ACCORDANCE WITH A-A-59551	

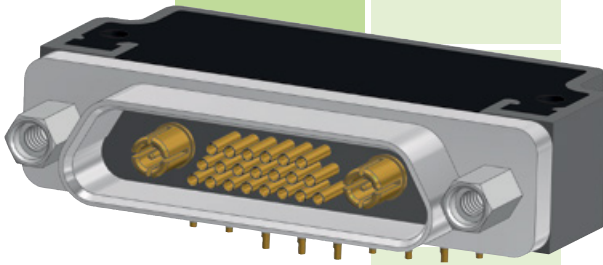

PCB connectors

METAL SHELL

- Condensed board right angle connector for flexible and rigid printed circuit boards.
- Operating temperature: 125°C with coaxial contacts, 150°C with power contacts.
- Several tail lengths available.

IDENTIFICATION CODE

MDCA 2 P3 S - CBR P G 1

SERIES

MDCA: Micro-D Combo AXON'.

CONNECTOR TYPE

1: Cadmium aluminium shell / **Z:** Black zinc nickel aluminium shell.
2: Nickel aluminum shell.

CONTACT ARRANGEMENT

C1 or **P1:** 4 contacts S3 - 51 way shell.
C3 or **P3:** 2 contacts S3 + 21 signals - 51 way shell.
C8 or **P8:** 4 contacts S2.2 - 25 way shell.
C10 or **P10:** 4 contacts S2.2 + 20 signals - 51 way shell.
Cx: coaxial contact; Px: power contact.

CONNECTOR GENDER

S: Receptacle connector.

ELECTRICAL CHARACTERISTICS OF THE COMBO CONTACTS

Coaxial contacts (S3) ■

50: 50Ω.
75: 75Ω.

Coaxial contact (S2.2) ■

50: 50Ω.

Power contacts ■

-: Power contacts.

PCB VERSION

with coaxial contacts:

75S: Board straight connector, 0.075" pitch for signal lines.
CBR: Condensed board right 0.100" pitch for signal lines.

with power contacts:

CBR: Condensed board right 0.100" pitch for signal lines.

HARDWARE

B: No hardware.

P: Jackposts.

Px (x: 1 to 5): Panel mount jackposts.

T: Threaded inserts installed.

W: Jackpost and threaded inserts installed.

Wx (x: 1 to 5): Panel mount jackposts and threaded inserts installed.

See pages 190 to 200 for hardware description.

CONDUCTOR TYPE (for signals)

G: Gold plated solid conductor AWG25.

T: Tin plated solid conductor AWG24.

Blank: For contact arrangements without signal contacts (C1/P1 or C8/P8).

TAIL LENGTH

1: 2.80mm (0.110").

2: 3.80mm (0.150").

3: 4.80mm (0.190").

METAL CONNECTORS ARE SUPPLIED WITH ANTI-STATIC PROTECTIVE DUST CAPS

BOARD STRAIGHT TYPE (BS) 0.075" PITCH (with coaxial contacts only)

► In a 51 way shell

- FEMALE PCB CONNECTOR (C3 CONFIGURATION)
- 2 COMBO CONTACTS (3.0 mm) + 21 SIGNALS

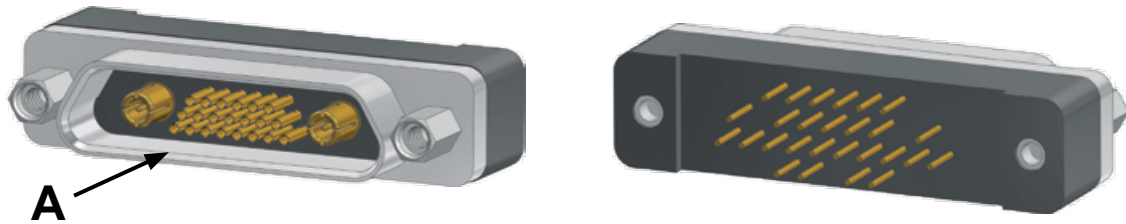

DIMENSIONS

Dimensions are in millimetres (inches).

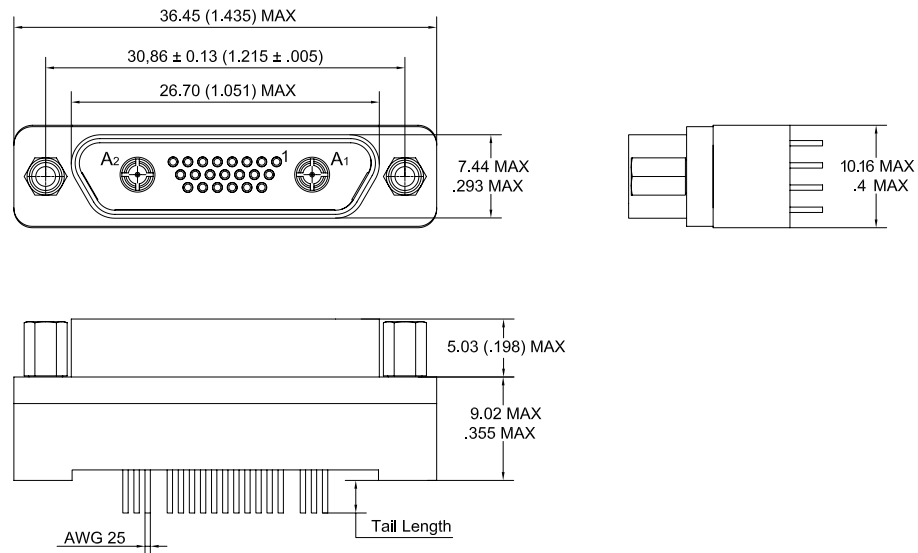

PCB LAYOUT

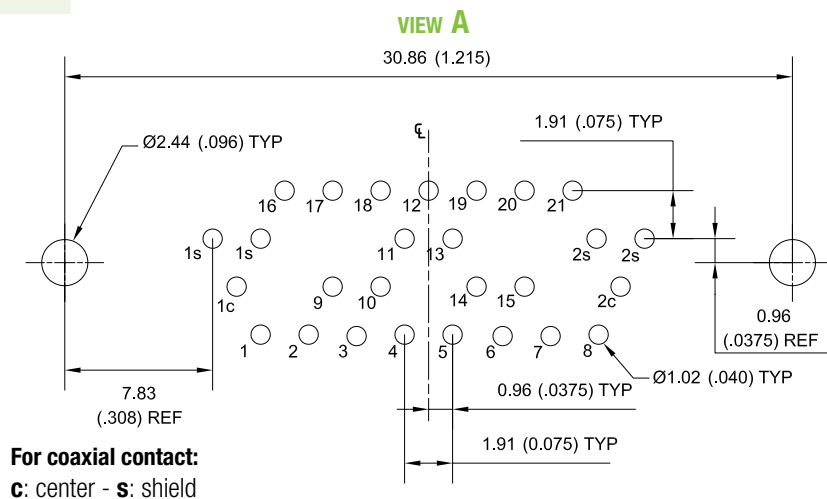

► In a 51 way shell

- FEMALE PCB CONNECTOR (C1 CONFIGURATION)
- 4 COMBO CONTACTS (3.0 mm)

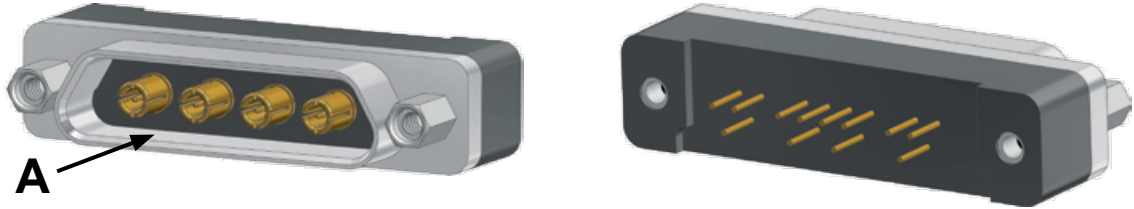

DIMENSIONS

Dimensions are in millimetres (inches).

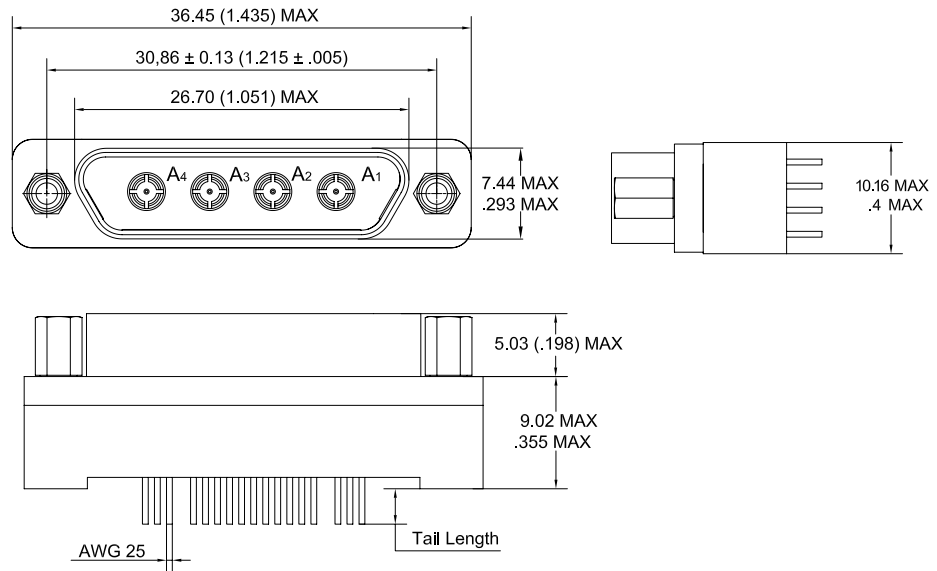

PCB LAYOUT

VIEW A

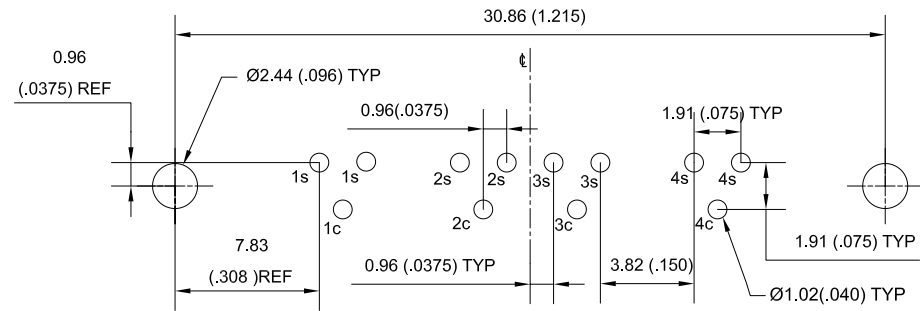

For coaxial contact:
c: center - s: shield

► In a 51 way shell

- FEMALE PCB CONNECTOR (C10 CONFIGURATION)
- 4 COMBO CONTACTS (2.2 mm) + 20 SIGNALS



DIMENSIONS

Dimensions are in millimetres (inches).

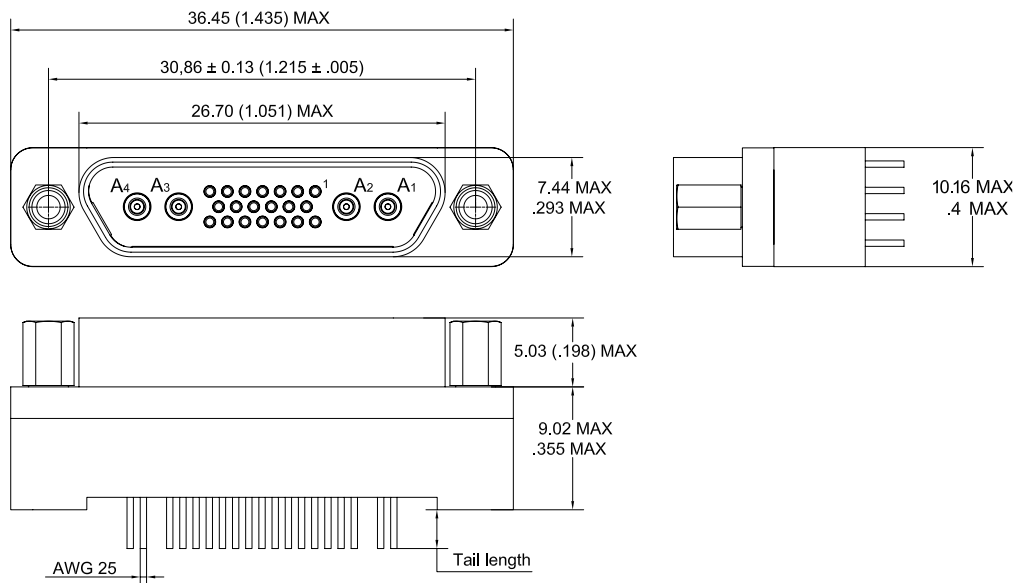

PCB LAYOUT

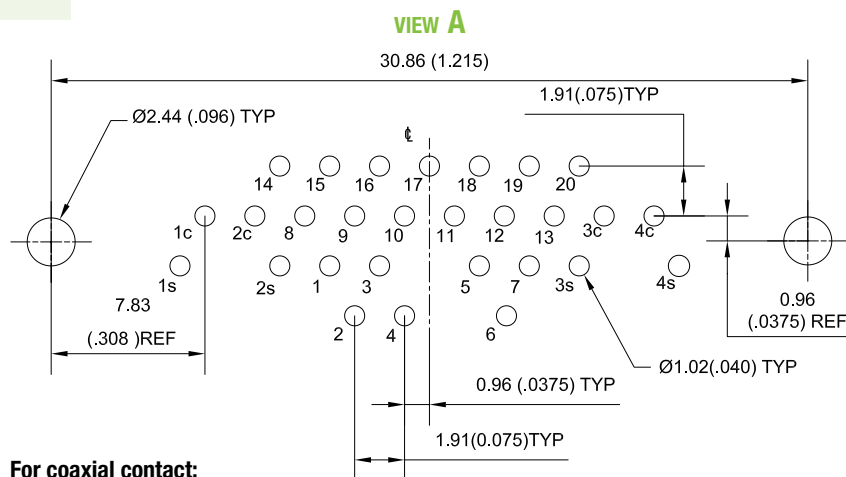

For coaxial contact:
c: center - s: shield

► In a 25 way shell

- FEMALE PCB CONNECTOR (C8 CONFIGURATION)
- 4 COMBO CONTACTS (2.2 mm)

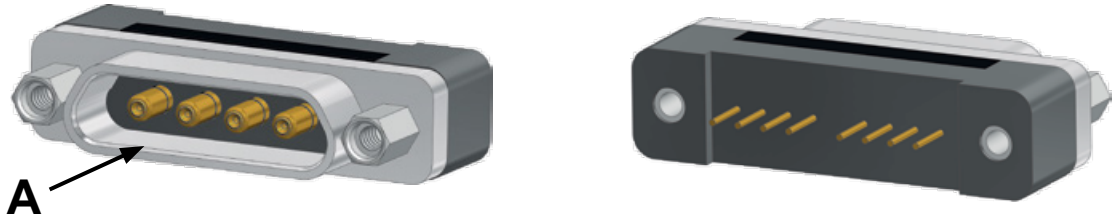

DIMENSIONS

Dimensions are in millimetres (inches).

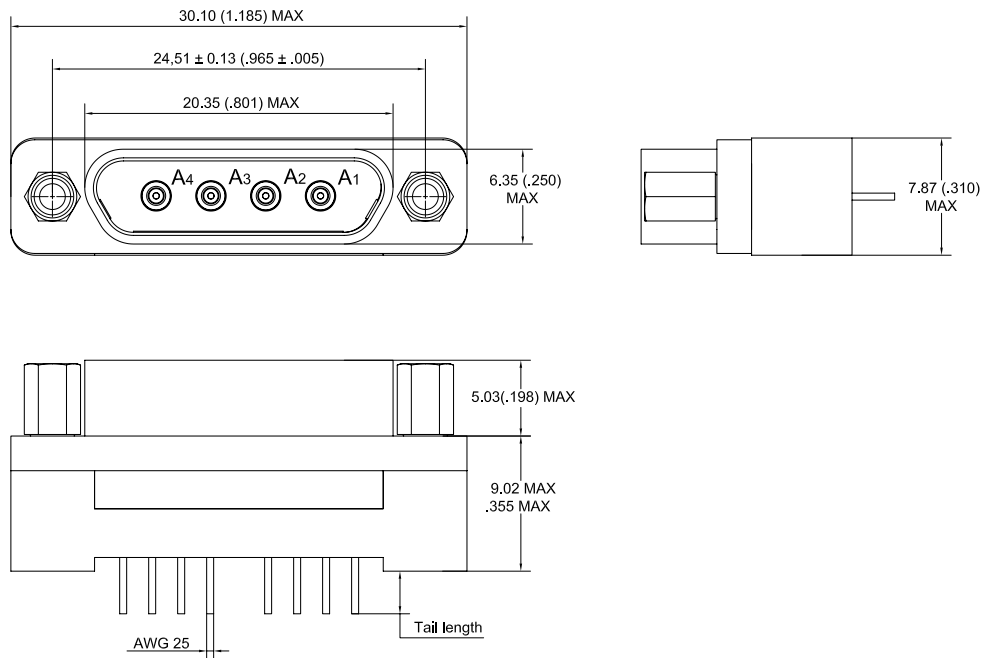

PCB LAYOUT

VIEW A

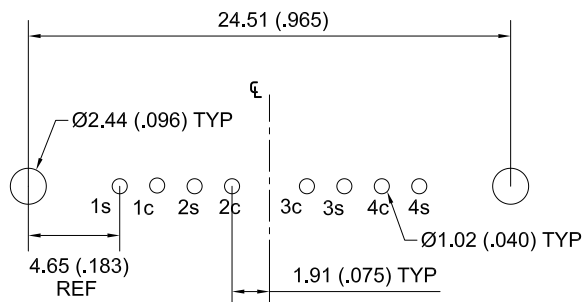

For coaxial contact:
c: center - s: shield

CONDENSED BOARD RIGHT ANGLE (0.100" PITCH) (coaxial and power combo contacts)

► In a 51 way shell

- FEMALE PCB CONNECTOR (C3/P3 CONFIGURATIONS)
- 2 COMBO CONTACTS (3.0 mm) + 21 SIGNALS

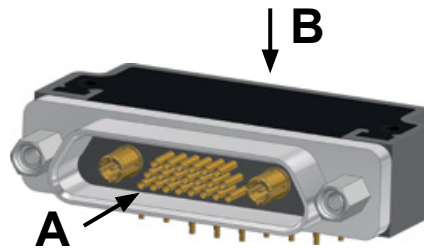

DIMENSIONS

Dimensions are in millimetres (inches).

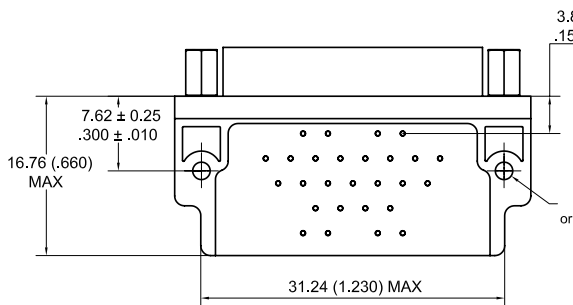
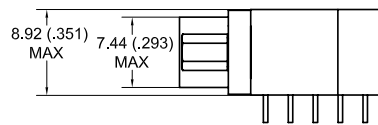
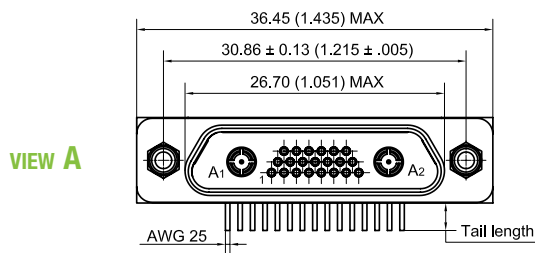

with coaxial contacts (C3)

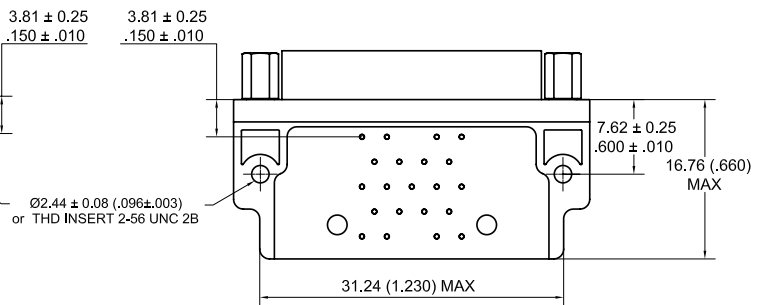

with power contacts (P3)

PCB LAYOUT

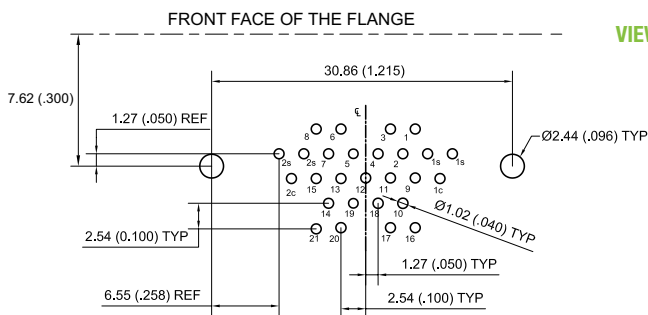

with coaxial contacts (C3)

For coaxial contact:
c: center - s: shield

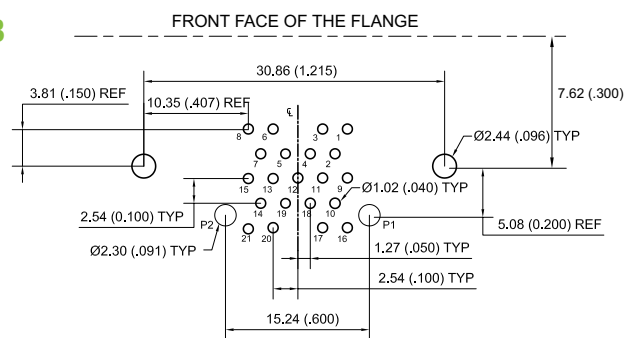

with power contacts (P3)

► In a 51 way shell

- FEMALE PCB CONNECTOR (C1/P1 CONFIGURATIONS)
- 4 COMBO CONTACTS (3.0 mm)

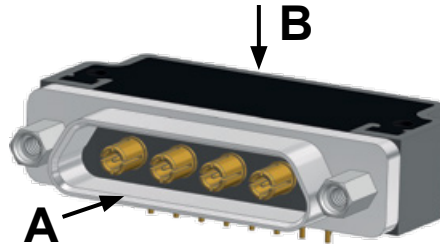

DIMENSIONS

Dimensions are in millimetres (inches).

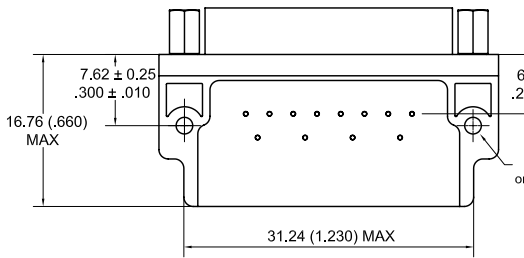
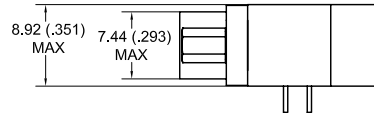
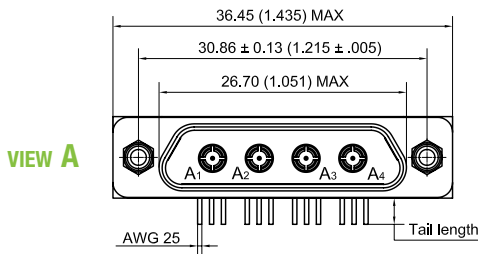

with coaxial contacts (C1)

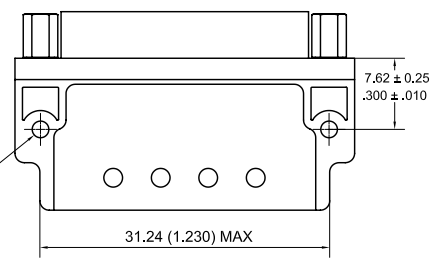

with power contacts (P1)

PCB LAYOUT

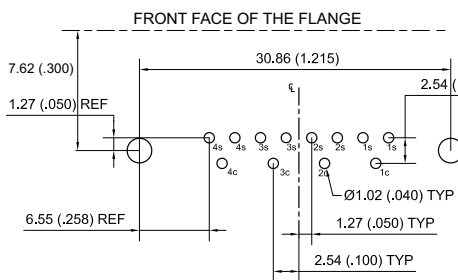

with coaxial contacts (C1)

VIEW B

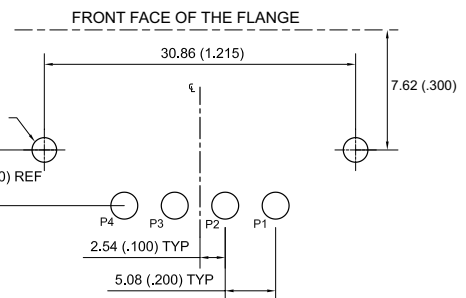

with power contacts (P1)

For coaxial contact:
c: center - s: shield

► In a 51 way shell

- FEMALE PCB CONNECTOR (C10/P10 CONFIGURATIONS)
- 4 COMBO CONTACTS (2.2 mm) + 20 SIGNALS

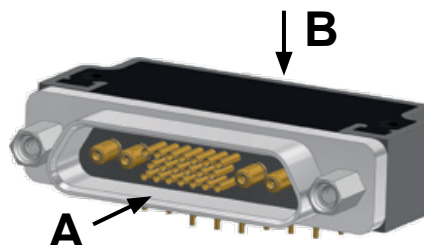

DIMENSIONS

Dimensions are in millimetres (inches).

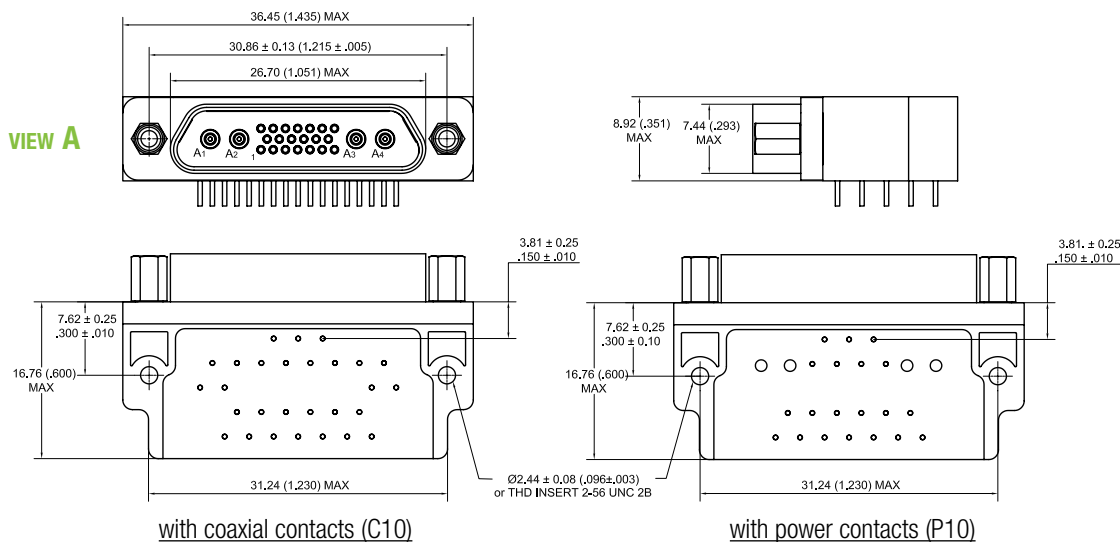

PCB LAYOUT

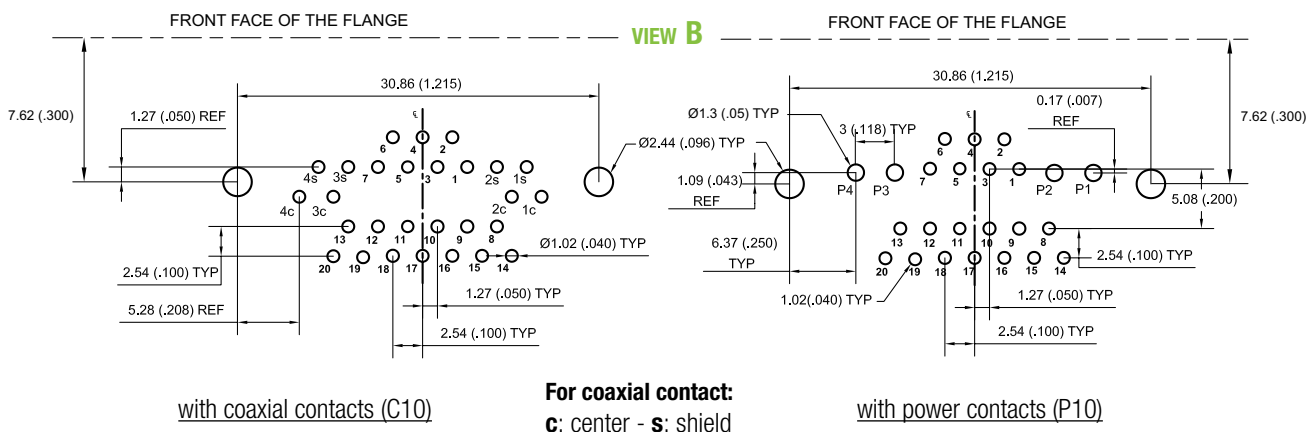

► In a 25 way shell

- FEMALE PCB CONNECTOR (C8/P8 CONFIGURATIONS)
- 4 COMBO CONTACTS (2.2 mm)

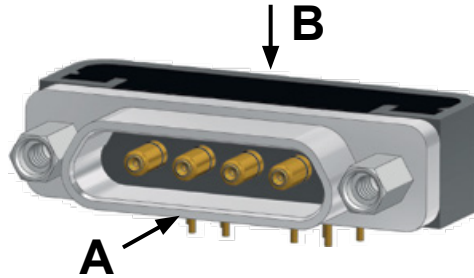

DIMENSIONS

Dimensions are in millimetres (inches).

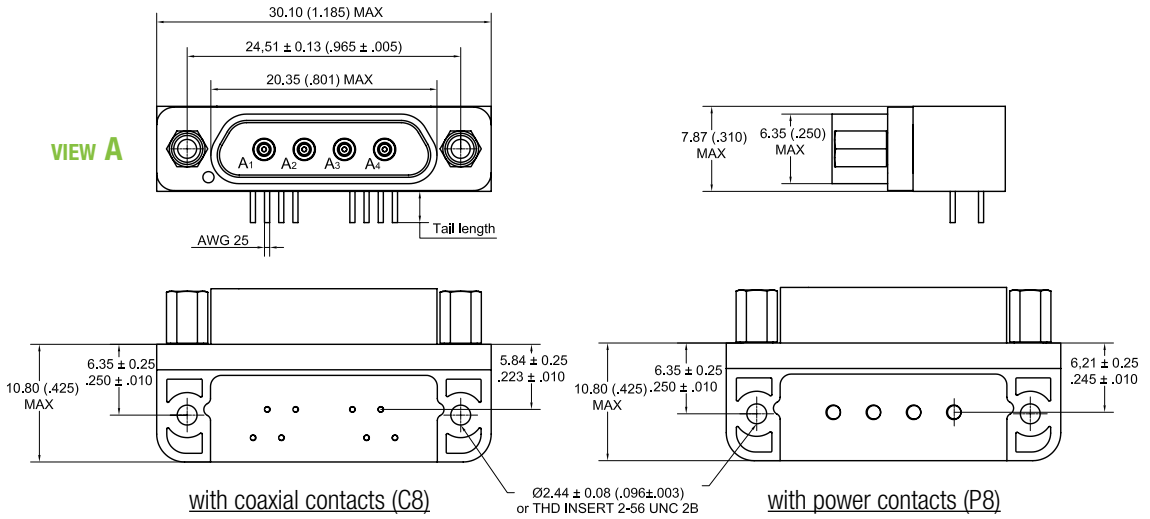

PCB LAYOUT

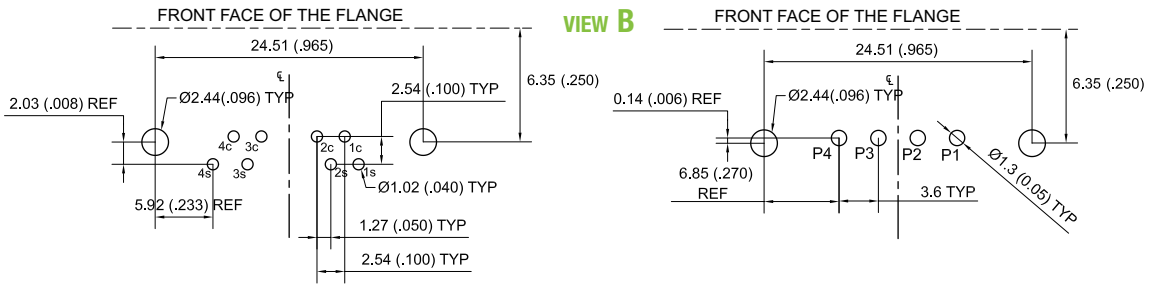

with coaxial contacts (C8)

For coaxial contact:
c: center - s: shield

with power contacts (P8)

Pigtail connectors

METAL SHELL

- High performance metal connectors
- Operating temperature: 125°C with coaxial contacts, 150°C with power contacts.

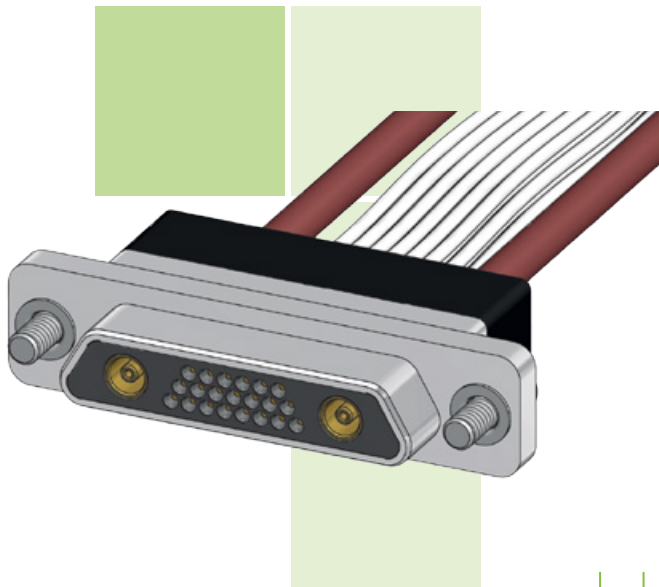

COMBO-D
CONNECTORS

Rectangular
Micro-D connectors

IDENTIFICATION CODE

MDCA 2 C1 P A 020 L 8 L 050 M

SERIES

MDCA: Micro-D Combo AXON'.

CONNECTOR TYPE

1: Cadmium aluminium shell / **Z:** Black zinc nickel aluminium shell.
2: Nickel aluminum shell.

CONTACT ARRANGEMENTS

C1 or P1: 4 contacts S3 - 51 way shell.
C3 or P3: 2 contacts S3 + 21 signals - 51 way shell.
C8 or P8: 4 contacts S2.2 - 25 way shell.
C10 or P10: 4 contacts S2.2 + 20 signals - 51 way shell.
Cx: coaxial contact - Px: power contact.

CONNECTOR GENDER

P: Plug connector. - **S:** Receptacle connector.

CABLE TYPE FOR COMBO LINES

Coaxial cable (S3) ■

A: AX086 (50Ω).
B: RG316 (50Ω).
C: RG179 (75Ω).

Coaxial cable (S2.2) ■

A: AX047 (50Ω).
C: RG178 (50Ω).

Power cable ■

A: AWG12 (only for S3).
B: AWG14 (only for S3).
C: AWG16 (recommended for S2.2).
D: AWG18 (recommended for S2.2).
E: AWG20 (recommended for S2.2).

Wires type Exx19 for power lines (xx=AWG)

WIRE LENGTH FOR COMBO LINES (in cm)

Attention! Wire length in centimeters (1cm = 10mm = 0.394").

L	L ≤ 10	10 < L ≤ 100	L > 100
in cm (inches)	L ≤ 3.940	3.940 < L ≤ 39.40	L > 39.40
TOLERANCE	-0 / +0.5	-0 / +3	-0 / +5
in cm (inches)	-0 / +0.200	-0 / +1.180	-0 / +1.970

COLOUR CODE FOR COMBO LINES

Coaxial lines: **C:** Brown (mandatory for and only for coaxial lines).
Power: **F:** All Yellow. - **L:** All white. - **W:** 10 color repeat (see page 30 for colour code).

WIRE TYPE FOR SIGNAL LINES

1: E 2607, AWG 26, 7 strands, 600V. **8:** E 3007, AWG 30, 7 strands, 600V.
4: E 2619, AWG 26, 19 strands, 600V. **A:** E 2407, AWG 24, 7 strands, 600V.
6: E 2807, AWG 28, 7 strands, 600V. **C:** E 2419, AWG 24, 19 strands, 600V.

COLOUR CODE FOR SIGNAL LINES

F: All yellow. - **L:** All white. - **W:** 10 color repeat (see page 30 for colour code).

WIRES LENGTH FOR SIGNAL LINES (in cm)

Attention! Wire length in centimeters (1cm = 10mm = 0.394").

L	L ≤ 10	10 < L ≤ 100	L > 100
in cm (inches)	L ≤ 3.940	3.940 < L ≤ 39.40	L > 39.40
TOLERANCE	-0 / +0.5	-0 / +3	-0 / +5
in cm (inches)	-0 / +0.200	-0 / +1.180	-0 / +1.970

HARDWARE

B: No hardware.
C: U-clips with low profile socket hex head jackscrews (removable).
D: U-clips with low profile slot head jackscrews (removable).
M: Low profile socket hex head jackscrews (removable).
N: High profile socket hex head jackscrews (removable).
S: low profile slot head jackscrews (removable).
FR: Float mount, rear panel mount (non removable).
Px (x: 1 to 5): Panel mount jackposts.

T: High profile slot head jackscrews (removable).
P: Jackposts (removable).
K: High profile slot head jackscrews (non removable).
L: Low profile socket hex head jackscrews (non removable).
F: Float mount, front panel mount (non removable).

See pages 190 to 200 for hardware description.

DIMENSIONS

Dimensions are in millimetres (inches).

MALE connector

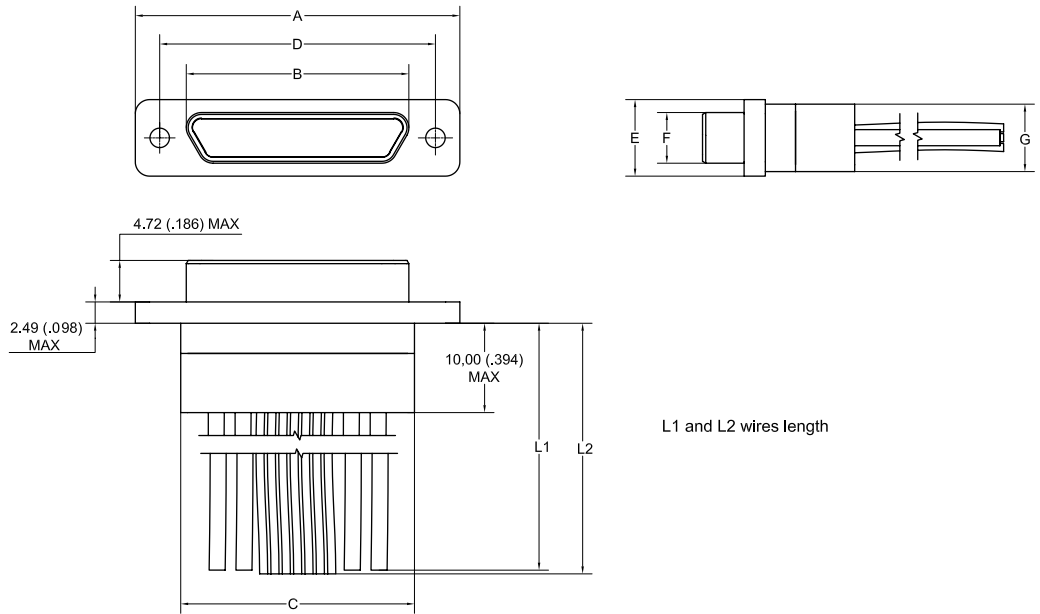

L1 and L2 wires length

MALE PIGTAIL	A ± 0.25 (±.010)	B max	C -0.46/+0.25 (-.018/+ .010)	D ± 0.13 (±.005)	E ± 0.25 (±.010)	F max	G max
		Male				Male	
C1 or P1	36.20 1.425	24.99 .984	26.42 1.040	30.86 1.215	8.66 .341	5.79 .228	7.87 .310
C3 or P3	36.20 1.425	24.99 .984	26.42 1.040	30.86 1.215	8.66 .341	5.79 .228	7.87 .310
C8 or P8	29.85 1.175	18.64 .734	20.07 .790	24.51 .965	7.57 .298	4.69 .185	6.86 .270
C10 or P10	36.20 1.425	24.99 .984	26.42 1.040	30.86 1.215	8.66 .341	5.79 .228	7.87 .310

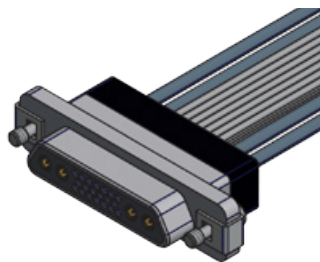

▲ COMBO 51 4 COAX S2.2 + 20 SIGN MALE PIGTAIL (C10)

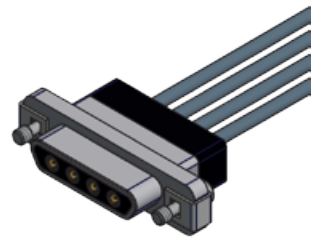

▲ COMBO 25 4 COAX S2.2 MALE PIGTAIL (C8)

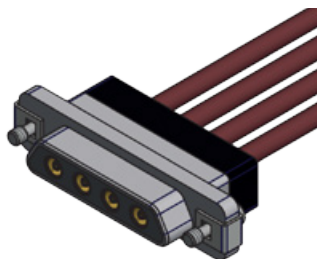

▲ COMBO 51 4 COAX S3 MALE PIGTAIL (C1)

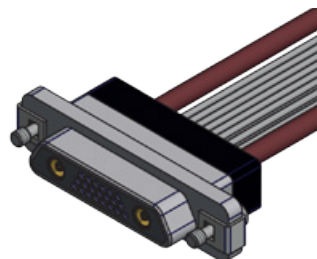

▲ COMBO 51 2 COAX S3 + 21SIGN MALE PIGTAIL (C3)

DIMENSIONS

Dimensions are in millimetres (inches).

FEMALE connector

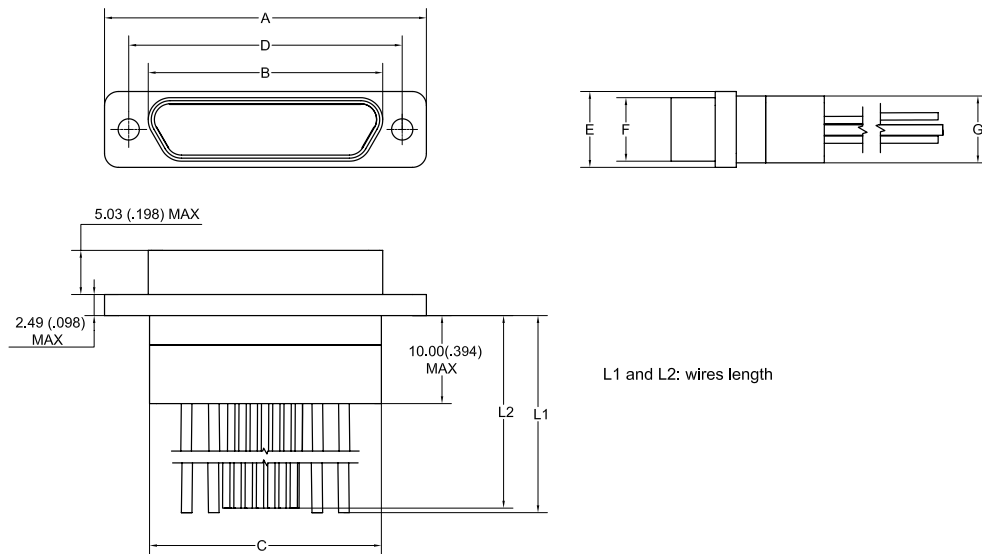

L1 and L2: wires length

FEMALE PIGTAIL	A ± 0.25 (±.010)	B max	C -0.46/+0.25 (-.018/+0.010)	D ± 0.13 (±.005)	E ± 0.25 (±.010)	F max	G max
		Female				Female	
C1 or P1	36.20 1.425	26.70 1.101	26.42 1.040	30.86 1.215	8.66 .341	7.44 .293	7.87 .310
C3 or P3	36.20 1.425	26.70 1.101	26.42 1.040	30.86 1.215	8.66 .341	7.44 .293	7.87 .310
C8 or P8	29.85 1.175	20.35 .801	20.07 .790	24.51 .965	7.57 .298	6.35 .250	6.86 .270
C10 or P10	36.20 1.425	26.70 1.101	26.42 1.040	30.86 1.215	8.66 .341	7.44 .293	7.87 .310

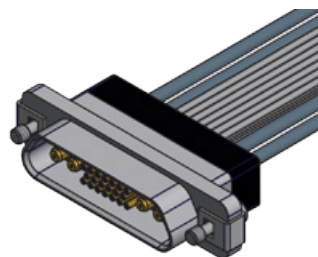

▲ COMBO 51 4 COAX S2.2 + 20 SIGN FEMALE PIGTAIL (C10)

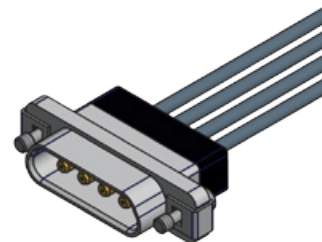

▲ COMBO 25 4 COAX S2.2 FEMALE PIGTAIL (C8)

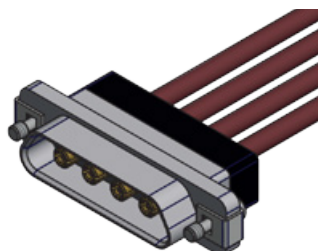

▲ COMBO 51 4 COAX S3 FEMALE PIGTAIL (C1)

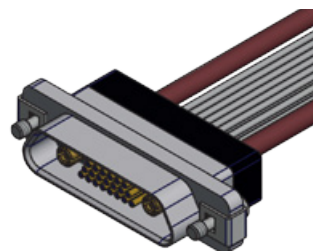

▲ COMBO 51 2 COAX S3 + 21 SIGN FEMALE PIGTAIL (C3)

COMBO Micro-D
connectorsSPECIAL
COMBO CONNECTORS

AXON' can develop on request special Combo Micro-D connectors based on all the standard shell sizes from 9 to 100 ways, or based on special shells such as the 120 way version or other custom configurations.

Combo Micro-D connectors can be offered as pigtails, as part of a complex harness or as PCB connectors, in either straight (BS style) or right angle versions (BR and CBR styles).

Some examples of special designs:

► Other possible arrangements

25 WAY

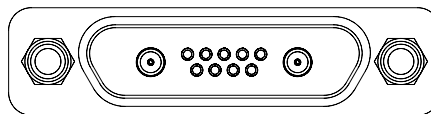

2 COMBO CONTACTS SIZE 2.2 mm + 9 SIGNALS

100 WAY

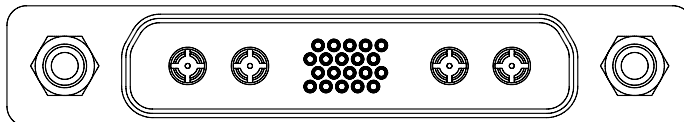

4 COMBO CONTACTS SIZE 3 mm + 20 SIGNALS

OTHER CONTACT ARRANGEMENTS AVAILABLE ON REQUEST

► Some examples of possible designs

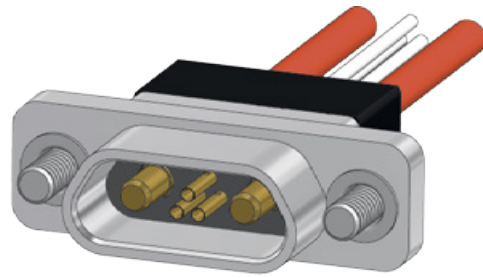

2 POWER COMBO CONTACTS + 3 SIGNALS

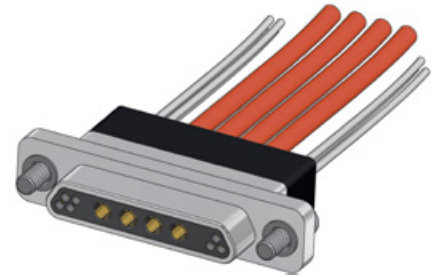

4 POWER COMBO CONTACTS + 7 SIGNALS

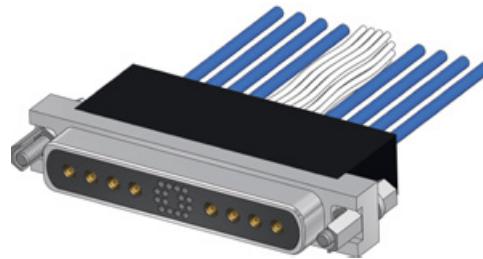

8 COAXIAL COMBO CONTACTS + 16 SIGNALS IN A 120 WAY MICRO-D CONNECTOR



5 COAXIAL COMBO CONTACTS

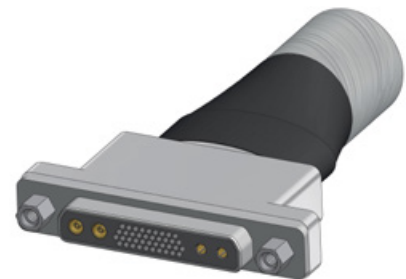

2 POWER COMBO S2.2 + 2 COAXIAL COMBO S3 CONTACTS + 40 SIGNALS, INTEGRATED IN A HARNESS

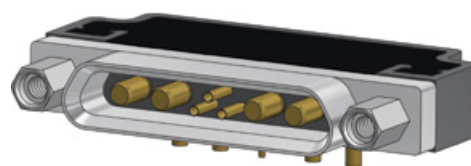

LOW PROFILE COMBO IN A 31 WAY SHELL

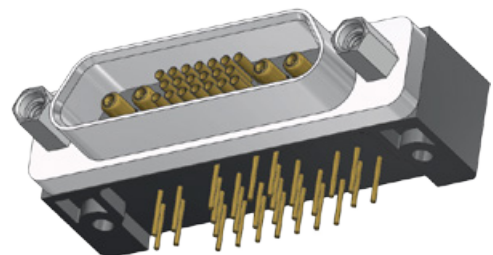

COMBO CBR WITH REDUCED DEPTH

HERMETIC CONNECTORS

- Introduction to hermetic connectors 164
- Rear panel mounting guide 165
- Hermetic connectors 166



Custom designed solutions

INTRODUCTION TO HERMETIC CONNECTORS

Hermetic connectors are used in applications where an enclosure needs to be isolated from the outside environment. Panel feed through is the main application for this type of connector.

In the vast majority of applications, the use of a hermetic encapsulant offers sufficient levels of hermeticity at a reasonable price. Only extreme environments require glass-to-metal sealing.

Furthermore, AXON' fully tests its hermetic Micro-D solutions to provide reliability and satisfaction to its customers. Helium leak rate is the most common and most reliable method to quantify a small leak.

Based on its expertise, AXON' can also design tailor-made connectors to fit your application needs.

CONNECTOR LEAK FLOW (mbar.l.s ⁻¹ or atm.cm ³ .s ⁻¹)	STANDARD MICRO-D MIL-DTL-83513	WATERPROOF ENCAPSULANT	AXON' HERMETIC ENCAPSULANT	AXON' GLASS-TO-METAL SEAL	LEVEL OF HERMETICITY
	1.E ⁺⁰⁰	↕	↕	↕	↕
1.E ⁻⁰¹					
1.E ⁻⁰²					
1.E ⁻⁰³					SOME MOISTURE INGRESS
1.E ⁻⁰⁴					
1.E ⁻⁰⁵					
1.E ⁻⁰⁶					GAS INGRESS
1.E ⁻⁰⁷					
1.E ⁻⁰⁸					
1.E ⁻⁰⁹					LIGHT WEIGHT GAS INGRESS
1.E ⁻¹⁰					

► ELECTRICAL & MECHANICAL PERFORMANCES

TECHNOLOGY CODE	HERMETIC ENCAPSULANT WITH SILICONE GASKET MDH1	HERMETIC ENCAPSULANT WITH FKM GASKET MDH2	GLASS-TO-METAL SEAL <i>on request</i>
MAXIMUM LEAK RATE*	1.10 ⁻⁶ mbar.l.s ⁻¹	1.10 ⁻⁸ mbar.l.s ⁻¹	< 1.10 ⁻¹¹ mbar.l.s ⁻¹
SERVICE TEMPERATURE RANGE	-55°C / +125°C	-30°C / +125°C	-55°C / +200°C**
CURRENT RATING	3 A MAX	3 A MAX	3 A MAX

*: Leak rates are measured by helium leak detection
 **: temperature range can be increased depending on application
 Other type of seals can also be offered

By mounting the flange to the panel, all AXON' hermetic Micro-D connectors can be used to maintain low or high pressure vacuum seals.

They are fully compatible with standard Micro-D connectors. A wide range of products is already available however custom interconnect solutions can be designed for specific panel cut-outs and thicknesses. Please contact us for any specific hermetic applications.



For other operating performances please refer to MIL-DTL-83513

REAR PANEL MOUNTING GUIDE

HERMETIC FEED THROUGH CONNECTORS

Micro-D hermetic feed through is only available as rear panel mount connectors. Specific jackposts are used to secure the feed through on the panel.

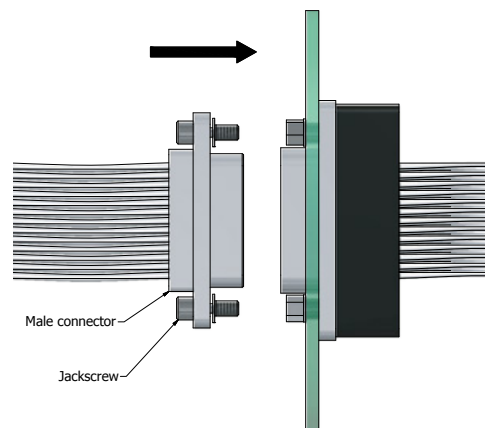
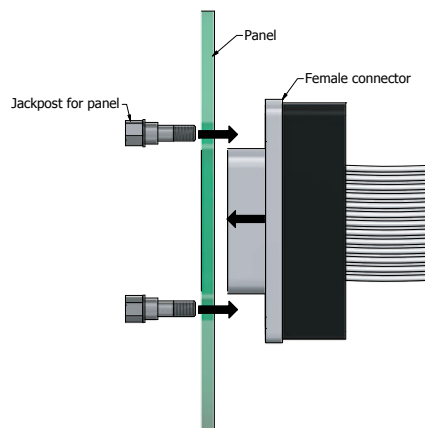
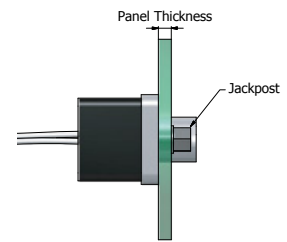
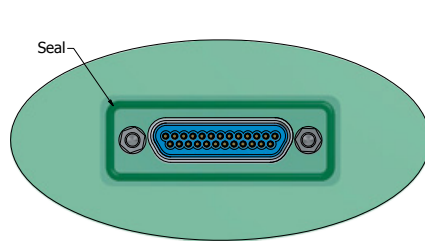

- Recommended Ra for panel surface: $<0.8 \mu\text{m}$
- Recommended torque (jackposts): 0.35 N.m
- Connector parts and panel must be cleaned off before mounting for better performances
- Design is made to be used without vacuum grease

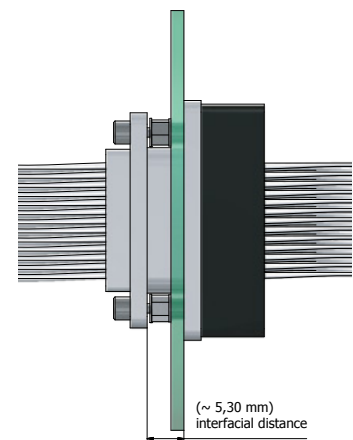

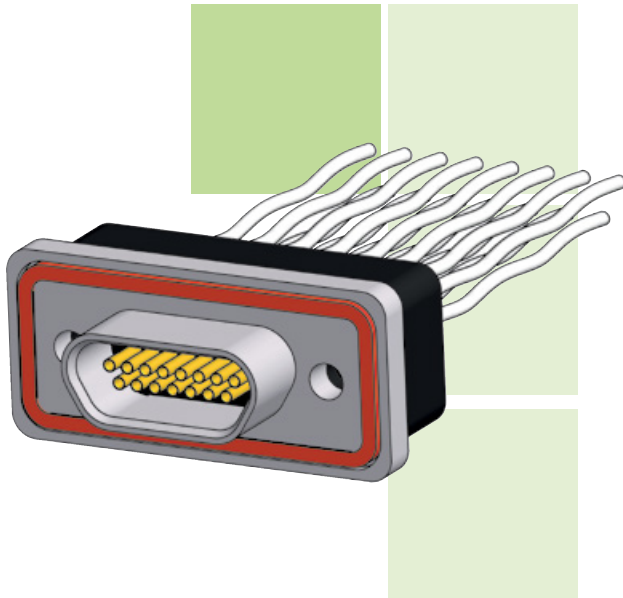

RECTANGULAR CONNECTORS

HERMETIC CONNECTOR

METAL SHELL

- High performance hermetic metal connector and PTFE wire.
- Male Twist Pin or female connector.
- 9 to 100 contacts.
- According to MIL-DTL-83513.

IDENTIFICATION CODE

MDH	1	51	S	4	L	050	B
-----	---	----	---	---	---	-----	---

SERIES

MDH: Micro-D Hermetic series.

HERMETIC TECHNOLOGY

- 1:** Hermetic potting fluorinated silicone gasket.
2: Hermetic potting FKM gasket.
Glass-To-Metal seal on request.

NUMBER OF CONTACTS 09, 15, 21, 25, 31, 37, 51, 100.
 See pages 26 & 27 for contact arrangements.

CONNECTOR GENDER

- P:** Male (pin contacts).
S: Female (socket contacts).

TERMINATION TYPE

- Solid uninsulated wires**
G: AWG 25 gold plated.
FS: Solder cup.

See page 29 for wire types.

COLOUR CODE

- BLANK:** If wire type is G or FS.
W: 10 colour repeat.
 See page 30 for colour code.

WIRE LENGTH (in cm)

Attention ! Wire length in centimetres - (1cm = 10mm = 0.394").
BLANK: If wire type is FS.

HARDWARE

- B:** No hardware.
Px (x= 1 to 5): Panel mount jackposts.
 See pages 190 to 200 for hardware description.

For colour codes F, L, W

- 1:** E 2607, AWG 26, 7 strands, 600V.
4: E 2619, AWG 26, 19 strands, 600V.
6: E 2807, AWG 28, 7 strands, 600V.
8: E 3007, AWG 30, 7 strands, 600V.
A: E 2407, AWG 24, 7 strands, 600V.
C: E 2419, AWG 24, 19 strands, 600V.
E: M22759/33, AWG 26, 19 strands, 600V.

- F:** All yellow.
L: All white.

For other design or glass to metal sealed version, please consult us.

DIMENSIONS

Dimensions are in millimetres (inches).

FEMALE connector

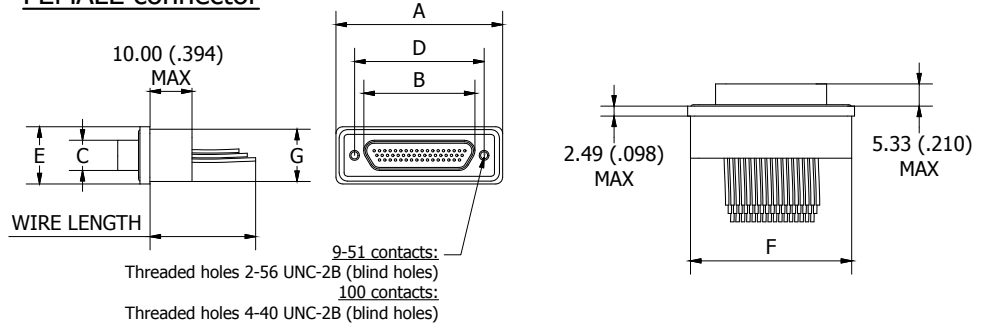

MALE connector

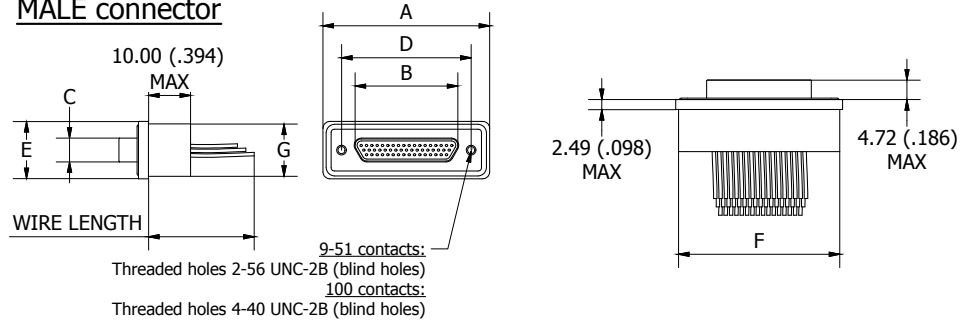

	A ± 0.25 (±.010)	B max.		C max.		D ± 0.13 (±.005)	E ± 0.25 (±.010)	F max.	G max.
		Male	Female	Male	Female				
9 P / 9 S	23.20 .913	8.48 .334	10.16 .400	4.69 .185	6.35 .250	14.35 .565	12.50 .492	22.50 .886	12.00 .472
15 P / 15 S	27.00 1.063	12.29 .484	14.00 .551	4.69 .185	6.35 .250	18.16 .715	12.50 .492	26.30 1.035	12.00 .472
21 P / 21 S	30.81 1.213	16.10 .634	17.81 .701	4.69 .185	6.35 .250	21.97 .865	12.50 .492	30.10 1.185	12.00 .472
25 P / 25 S	33.40 1.315	18.64 .734	20.35 .801	4.69 .185	6.35 .250	24.51 .965	12.50 .492	32.70 1.287	12.00 .472
31 P / 31 S	37.16 1.463	22.45 .884	24.16 .951	4.69 .185	6.35 .250	28.32 1.115	12.50 .492	36.50 1.437	12.00 .472
37 P / 37 S	41.00 1.614	26.26 1.034	27.96 1.101	4.69 .185	6.35 .250	32.13 1.265	12.50 .492	40.30 1.586	12.00 .472
51 P / 51 S	39.70 1.563	24.99 .984	26.70 1.051	5.79 .228	7.44 .293	30.86 1.215	13.60 .535	39.00 1.536	13.00 .512
100 P / 100 S	59.70 2.350	35.15 1.384	36.86 1.451	6.88 .271	8.46 .333	45.72 1.800	15.70 1.618	59.00 2.323	14.50 .571

NON-MAGNETIC CONNECTORS

Non-magnetic Micro-D interconnect solutions 170

PIGTAIL CONNECTORS

- Non-magnetic metal shell connectors 172
- Non-magnetic low profile metal shell connectors 173
- Non-magnetic plastic shell connectors 174

PCB CONNECTORS

- PCB connectors overview 175
- Non-magnetic PCB connectors 176



NON-MAGNETIC
CONNECTORS

Rectangular
Micro-D connectors

NON-MAGNETIC MICRO-D INTERCONNECT SOLUTIONS



▲ FIGURE 1: Location of magnetic test facility (30m away from possible interference)



▲ FIGURE 2: This item's initial magnetic state is being measured using a three-axis probe, whilst protected by the magnetic shield

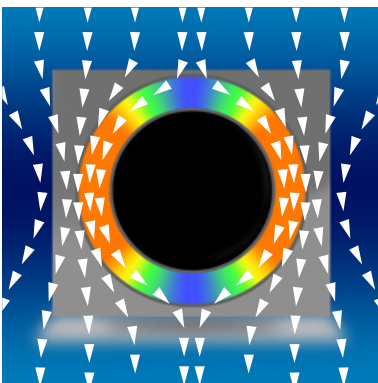

▲ FIGURE 3: Diagram showing the effect of the magnetic shield on the Earth's magnetic field. In white, the magnetic field lines. In color, the intensity of the magnetic field within the shield, red for high intensity and blue for low intensity. The black area in the center is the area used to measure the initial magnetic state of the item.

Interest in powerful magnetic fields and accurate magnetic sensors has significantly increased in high-tech industries over the past decades. Various applications (MRI, low magnetic field detection systems, etc...) now use these complex phenomena, but accurately measuring a magnetic field is challenging. The difficulty comes mainly from interference caused by any ferromagnetic material surrounding the probes.

At the same time, systems using such magnetic fields are spreading and components tend to be closer to each other, further increasing magnetic interference.

A standard Micro-D connector made to the requirements of MIL-DTL-83513 contains materials such as austenitic stainless steel, which can easily be magnetized. To avoid interference from interconnects, AXON' has developed a new product range: non-magnetic Micro-D connectors.

These connectors have limited or no influence on magnetic field lines, improving the reliability of magnetic measurements, even down to nanoTesla level, 10^{-4} times lower than the Earth's magnetic field. AXON's non-magnetic Micro-D connectors have been designed using new materials and surface treatments, avoiding ferromagnetic materials. The manufacturing process has also been developed to keep them "as clean as possible" magnetically.

► MAGNETIC TESTING

In order to further enhance and test its non-magnetic product range, AXON' has developed its own test equipment and procedure, based on recognized standards, to characterize and quantify the magnetic influence of connectors on their environment.

The first step is to measure the initial magnetic state of the Unit Under Test (UUT) using a three-axis probe. Then a high magnetic field of 0.5T (Earth's magnetic field is about $50\mu\text{T}$ in Europe), is applied to the UUT.

Finally, the intensity of the field is gradually decreased to nil, and the residual magnetism level of the UUT is measured with the three-axis probe. As a result of this procedure, the influence of a strong magnetic field on the UUT is known.

To minimize the possibility of magnetic interference from the surrounding area, the tests are carried out in a specially-constructed facility (see figure 1) which is made from magnetically neutral materials. Additionally a magnetic shield is used to shield the item tested from the Earth's magnetic field (see figures 2 & 3).

NON-MAGNETIC MICRO-D INTERCONNECT SOLUTIONS

For a material studied in a magnetostatic state, a link between the physical quantities of the Maxwell's equations can be simplified to:

$$B = \mu_0 (H+M)$$

Where B is the magnetic flux density generated by the material in Tesla (T),
 μ_0 is the magnetic permeability of vacuum in Henry per meter (H/m),
 H is the magnetic field intensity generated by the environment in Ampere per meter (A/m),
 M is the sum of the magnetic moments of the material or magnetization in Ampere per meter (A/m).

If the item is perfectly non-magnetic, $M = 0$. So if the magnetic field generated by the environment is also nil ($H = 0$), the measured magnetic flux density B is also nil.

Relationship between physical quantities commonly used:

$$1 \text{ Oersted} = \left(\frac{10^3}{4\pi} \right) \text{ A/m}$$

$$1 \text{ T} = 10^4 \text{ Gauss} = 10^9 \text{ Gamma}$$

GENERAL PERFORMANCES

Residual Magnetic Level	NMB*: ≤ 200 nT residual magnetism level NMC*: ≤ 20 nT residual magnetism level NMD* on request: ≤ 2 nT residual magnetism level
Operating temperature range	-55°C / +200°C
Current rating	3 A max

*: NMB, NMC & NMD levels are defined by NASA GSFC S-311 for non-magnetic subminiature connectors and adapted to the dimensions of microminiature connectors.



MATERIAL & FINISH

SHELL	Aluminium alloy 6061 with custom non-magnetic plating or titanium
MOULDED INSULATOR	Liquid Crystal Polymer (LCP)
INTERFACIAL SEAL	Fluorosilicone rubber
PIN CONTACT	Copper and beryllium copper, gold over nickel plating (custom non-magnetic plating)
SOCKET CONTACT	Copper alloy, gold over nickel plating (custom non-magnetic plating)
ENCAPSULANT	Epoxy resin
HARDWARE	Titanium TA6V and beryllium copper
SOLID UNINSULATED WIRES & PCB TERMINALS	AWG 25 Silver Plated Copper

LOWER MAGNETISM LEVEL: Please contact us for a 2 nT residual magnetism level or for other magnetic requirements

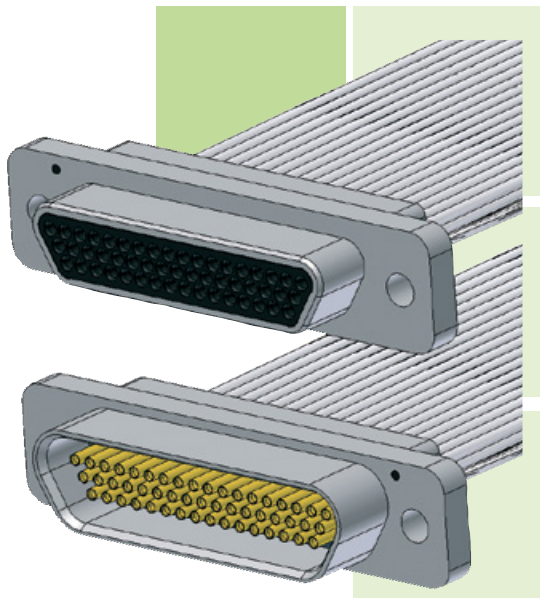

NON-MAGNETIC CONNECTOR

METAL SHELL

- For strong magnetic field environments.
 - Minimal magnetic disturbance.
- High performance metal connector and PTFE wire.
 - Environmentally sealed.
- Operating temperature: 125 or 200°C.
 - 9 to 100 contacts.

IDENTIFICATION CODE



SERIES

MDN: Micro-D Non-magnetic series.

CONNECTOR TYPE

- 1A:** < 200 nT - Nickel aluminium shell + potting 125°C.
 - 1B:** < 200 nT - Nickel aluminium shell + potting 200°C.
 - 2A:** < 20 nT - Titanium shell + potting 125°C.
 - 2B:** < 20 nT - Titanium shell + potting 200°C.
- Contact us for < 2 nT connectors.*

NUMBER OF CONTACTS **09, 15, 21, 25, 31, 37, 51DR, 51, 69, 100.**
See pages 26 & 27 for contact arrangements.

CONNECTOR GENDER

- P:** Male (pin contacts).
- S:** Female (socket contacts).

TERMINATION TYPE

- For colour codes F, L, W
- 1:** E 2607, AWG 26, 7 strands, 600V.
 - 4:** E 2619, AWG 26, 19 strands, 600V.
 - 6:** E 2807, AWG 28, 7 strands, 600V.
 - 8:** E 3007, AWG 30, 7 strands, 600V.
 - A:** E 2407, AWG 24, 7 strands, 600V.
 - C:** E 2419, AWG 24, 19 strands, 600V.
 - E:** M22759/33, AWG 26, 19 strands, 600V.
- For colour code V only
- 3:** M22759/11, AWG26, 19 strands, 600V.
 - F:** E2607, AWG26, 7 strands, 600V.
- Solid uninsulated wires**
- S:** AWG 25 silver plated.
- FS:** Solder cup.
See page 29 for wire types.

COLOUR CODE

- F:** All yellow.
 - L:** All white.
 - BLANK:** If wire type is S or FS.
 - W:** 10 colour repeat.
 - V:** MIL-STD-681 striped (only for wire types 3 and F).
- See page 30 for colour code.*

WIRE LENGTH (in cm)

Attention! Wire length in centimetres - (1cm = 10mm = 0.394").
BLANK: If termination type is FS.

L	L ≤ 10	10 < L ≤ 100	L > 100
in cm (inches)	L ≤ 3.940	3.940 < L ≤ 39.40	L > 39.40
TOLERANCE	-0 / +0.5	-0 / +3	-0 / +5
in cm (inches)	-0 / +0.200	-0 / +1.180	-0 / +1.970

HARDWARE

- B:** No hardware.
- P:** Titanium jackposts (removable).
- M:** Titanium non-magnetic low profile hex socket head jackscrews (removable).
- N:** Titanium non-magnetic high profile hex socket head jackscrews (removable).
- Px** (x: 1 to 5): Titanium panel mount jackposts.
See pages 190 to 200 for hardware description.

NON-MAGNETIC CONNECTOR

NON-MAGNETIC CONNECTORS

Rectangular Micro-D connectors



LOW PROFILE METAL SHELL

- For strong magnetic field environments.
- Minimal magnetic disturbance.
- High performance metal connector and PTFE wire.
- Environmentally sealed.
- Operating temperature: 125 or 200°C.
- 9 to 51 contacts.

IDENTIFICATION CODE



SERIES

MDN: Micro-D Non-magnetic series.

CONNECTOR TYPE

- 1A:** < 200 nT - Nickel aluminium shell + potting 125°C.
 - 1B:** < 200 nT - Nickel aluminium shell + potting 200°C.
 - 2A:** < 20 nT - Titanium shell + potting 125°C.
 - 2B:** < 20 nT - Titanium shell + potting 200°C.
- Contact us for < 2 nT connectors.**

NUMBER OF CONTACTS L09, L15, L21, L25, L31, L37, L51.
See pages 26 & 27 for contact arrangements.

CONNECTOR GENDER

- P:** Male (pin contacts).
- S:** Female (socket contacts).

TERMINATION TYPE

- For colour codes F, L, W
- 1:** E 2607, AWG 26, 7 strands, 600V.
 - 4:** E 2619, AWG 26, 19 strands, 600V.
 - 6:** E 2807, AWG 28, 7 strands, 600V.
 - 8:** E 3007, AWG 30, 7 strands, 600V.
 - A:** E 2407, AWG 24, 7 strands, 600V.
 - C:** E 2419, AWG 24, 19 strands, 600V.
 - E:** M22759/33, AWG 26, 19 strands, 600V.
- For colour code V only
- 3:** M22759/11, AWG26, 19 strands, 600V.
- F:** E2607, AWG26, 7 strands, 600V.
Solid uninsulated wires
S: AWG 25 silver plated.
- FS:** Solder cup.
See page 29 for wire types.

COLOUR CODE

- F:** All yellow.
 - L:** All white.
 - BLANK:** If wire type is S or FS.
 - W:** 10 colour repeat.
 - V:** MIL-STD-681 striped (only for wire types 3 and F).
- See page 30 for colour code.

WIRE LENGTH (in cm)

Attention! Wire length in centimetres - (1cm = 10mm = 0.394").
BLANK: If termination type is FS.

HARDWARE

- B:** No hardware.
- P:** Titanium jackposts (removable).
- M:** Titanium non-magnetic low profile hex socket head jackscrews (removable).
- N:** Titanium non-magnetic high profile hex socket head jackscrews (removable).
- Px** (x: 1 to 5): Titanium panel mount jackposts.
See pages 190 to 200 for hardware description.

L	L ≤ 10	10 < L ≤ 100	L > 100
in cm (inches)	L ≤ 3.940	3.940 < L ≤ 39.40	L > 39.40
TOLERANCE	-0 / +0.5	-0 / +3	-0 / +5
in cm (inches)	-0 / +0.200	-0 / +1.180	-0 / +1.970

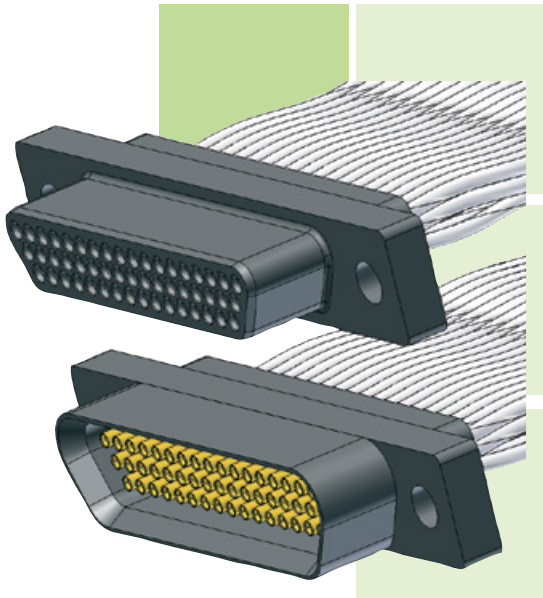

NON-MAGNETIC CONNECTOR

PLASTIC SHELL

- For strong magnetic field environments.
 - Minimal magnetic disturbance.
- High performance plastic connector and PTFE wire.
 - Environmentally sealed.
- Operating temperature: 125 or 200°C.
 - 9 to 51 contacts.

IDENTIFICATION CODE



SERIES

MDN: Micro-D Non-magnetic series.

CONNECTOR TYPE

P: < 20 nT - Plastic shell + potting 125°C.
L: < 20 nT - Plastic shell + potting 200°C.

NUMBER OF CONTACTS 09, 15, 21, 25, 31, 37, 51.
 See pages 26 & 27 for contact arrangements.

CONNECTOR GENDER

P: Male (pin contacts).
S: Female (socket contacts).

TERMINATION TYPE

For colour codes **F, L, W**

- 1:** E 2607, AWG 26, 7 strands, 600V.
- 4:** E 2619, AWG 26, 19 strands, 600V.
- 6:** E 2807, AWG 28, 7 strands, 600V.
- 8:** E 3007, AWG 30, 7 strands, 600V.
- A:** E 2407, AWG 24, 7 strands, 600V.
- C:** E 2419, AWG 24, 19 strands, 600V.
- E:** M22759/33, AWG 26, 19 strands, 600V.

For colour code **V** only

- 3:** M22759/11, AWG26, 19 strands, 600V.
 - F:** E2607, AWG26, 7 strands, 600V.
- Solid uninsulated wires
S: AWG 25 silver plated.

FS: Solder cup.

See page 29 for wire types.

COLOUR CODE

F: All yellow.
L: All white.

BLANK: If wire type is S or FS.
W: 10 colour repeat.

V: MIL-STD-681 striped (only for wire types 3 and F).
 See page 30 for colour code.

WIRE LENGTH (in cm)

Attention! Wire length in centimetres - (1cm = 10mm = 0.394").
BLANK: If termination is FS.

L	L ≤ 10	10 < L ≤ 100	L > 100
in cm (inches)	L ≤ 3.940	3.940 < L ≤ 39.40	L > 39.40
TOLERANCE	-0 / +0.5	-0 / +3	-0 / +5
in cm (inches)	-0 / +0.200	-0 / +1.180	-0 / +1.970

HARDWARE

- B:** No hardware.
 - P:** Titanium jackposts (removable).
 - M:** Titanium non-magnetic low profile hex socket head jackscrews (removable).
 - N:** Titanium non-magnetic high profile hex socket head jackscrews (removable).
 - Px** (x: 1 to 5): Titanium panel mount jackposts.
- See pages 190 to 200 for hardware description.

PCB CONNECTORS OVERVIEW

AXON' Micro-D Printed Circuit Board connectors are designed for interconnection of PCB's inside-the-box to external cables.
AXON' Micro-D PCB connectors are available in two layouts (0.100" pitch and 0.075" pitch) and in two configurations (vertical mount and right angle mount connectors) for flexible and rigid printed circuit boards.

NOTE: typically, the PCB connector tends to be female, however male versions are equally available.

NON-MAGNETIC PCB CONNECTORS 0.100" PITCH

CBR 0.100" Condensed Right Angle mount

Available from 9 to 100 ways
Available in metal shell
PCB code: **CBR**

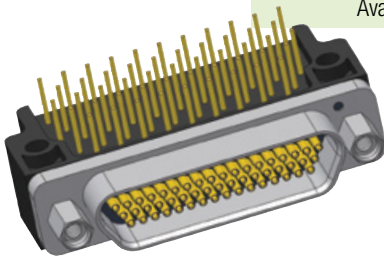

See pages 78 to 85*.

CBP 0.100" Condensed Right Angle mount low profile

Available from 9 to 51 ways
Available in metal and plastic shell
PCB code: **CBP**

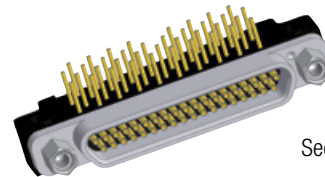
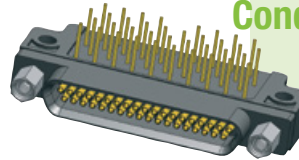

See pages 86 to 91*.

NON-MAGNETIC PCB CONNECTORS 0.075" PITCH

BS 0.075" Vertical mount

Available from 9 to 100 ways
Available in metal and plastic shell
PCB code: **75SB**

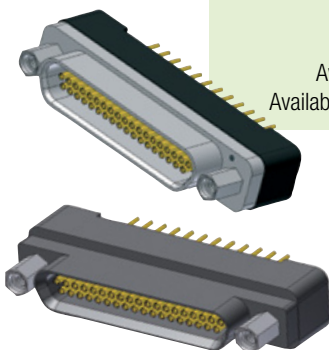

See pages 116 to 125*.

CBR 0.075" Condensed Right Angle mount

Available from 9 to 100 ways
Available in metal shell
PCB code: **75RB**

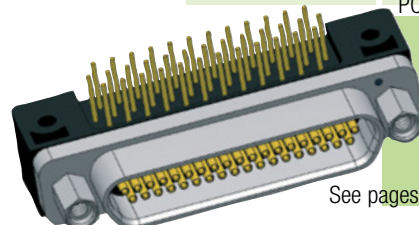

See pages 178 to 184*.

*: Non-magnetic PCB connectors have the same dimensions and PCB layouts as standard PCB connectors.
Construction of the references on the next page.

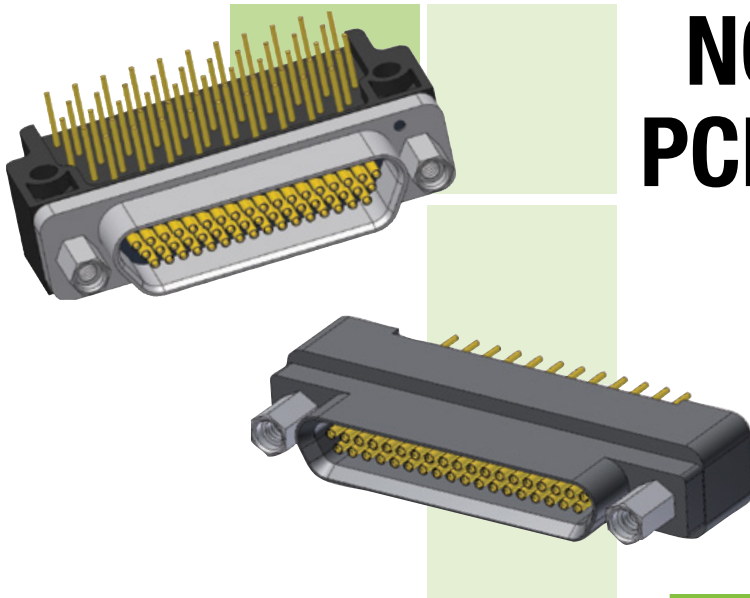

NON-MAGNETIC PCB CONNECTOR

- For strong magnetic field environments.
 - Minimal magnetic disturbance.
- Condensed board right angle connector for flexible and rigid printed circuit boards.
 - Operating temperature: 125 or 200°C.
 - Several tail lengths available.
- 9 to 100 contacts (up to 51 for plastic connectors).

IDENTIFICATION CODE



SERIES

MDN: Micro-D Non-magnetic series.

CONNECTOR TYPE

- 1A:** < 200 nT - Nickel aluminium shell + potting 125°C.
 - 1B:** < 200 nT - Nickel aluminium shell + potting 200°C.
 - 2A:** < 20 nT - Titanium + potting 125°C.
 - 2B:** < 20 nT - Titanium + potting 200°C.
 - P:** < 20 nT - Plastic shell + potting 125°C.
 - L:** < 20 nT - Plastic shell + potting 200°C.
- Contact us for < 2 nT connectors.**

NUMBER OF CONTACTS

- 09, 15, 21, 25, 31, 37, 51DR*, 51, 69*, 100*.**
 - L09, L15, L21, L25, L31, L37, L51.**
- See pages 26 & 27 for contact arrangements.**

CONNECTOR GENDER

- P:** Male (pin contacts).
- S:** Female (socket contacts).

PCB VERSION

- CBR:** 0.100" Condensed Board Right Angle**.
- CBP:** 0.100" Condensed Right Angle Low Profile***.
- 75RB:** 0.075" Condensed Board Right Angle**.
- 75SB:** 0.075" Board Straight***.

HARDWARE

- B:** No hardware.
 - P:** Titanium jackposts (removable).
 - Px (x: 1 to 5):** Titanium panel mount jackposts.
- See pages 190 to 200 for hardware description.**

CONDUCTOR TYPE

- S:** Silver plated solid conductor AWG 25.

TAIL LENGTH

- 1:** 2.80 mm (0.110").
- 2:** 3.80 mm (0.150").
- 3:** 4.80 mm (0.190").
- 4:** 6.35 mm (0.250").
- 5:** 3.25 mm (0.127").
- 6:** 3.56 mm (0.140").
- 7:** 4.37 mm (0.172").

Tolerance: ± 0.38 mm (0.015").
Other lengths available on request.

*: not for plastic shell connectors.
 **: only for standard profile metal shells.
 ***: only for plastic and low profile metal shells.

120 WAY MICRO-D CONNECTORS

- 120 way Micro-D connectors 178
- 120 way connectors for cable and harnesses 181
- Surface mount PCB card edge connectors 182
- BS connector 183
- Connector saver 183
- PCB layouts 184



*Rectangular
Micro-D connectors*

Micro-D connectors

120 WAY MICRO-D CONNECTORS

An enduring trend in the electronics industry is the continuing drive towards miniaturisation. This leads in turn to ever greater cabling densities with an ever larger number of signals required within limited space constraints. In answer to these challenges, AXON' CABLE has developed a range of 120 way Micro-D connectors. They are available as pigtailed or within assemblies but can equally be supplied as PCB connectors in either surface mount or through hole format. Connector savers are part of the range.

These connectors can be used for any applications where severe environmental conditions and high density cabling are critical. Keying hardware is an option.

AXON' can offer specific numbers of contacts for custom designed applications. Specific designs are not contained within the MIL specification but AXON's solutions remain fully compatible with the MIL-DTL-83513 standard as far as performance and construction are concerned.

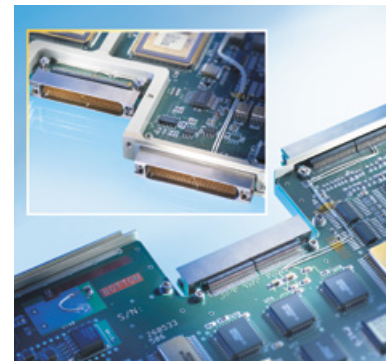

▲ 120 WAY MICRO-D CARD
EDGE CONNECTOR

► Contact arrangements

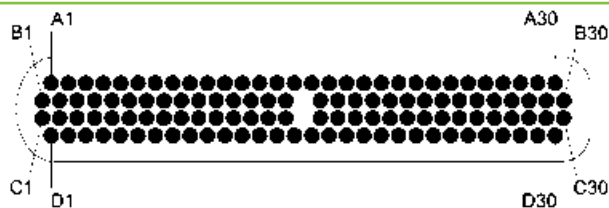

MATING FACE OF THE 120 WAY MALE CONNECTOR

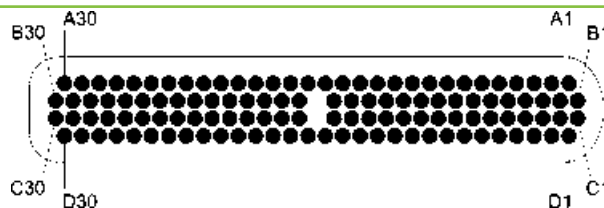

MATING FACE OF THE 120 WAY FEMALE CONNECTOR

1.27 mm (.050") contact spacing.
1.27 mm (.050") spacing between two rows.

► References

DESIGNATION	REFERENCE	COMMENTS	PAGE
120 WAY PLUG CONNECTOR FOR CABLE OR ASSEMBLY	P562620	Wire, length and colour type to be defined	181
120 WAY SOCKET CONNECTOR FOR CABLE OR ASSEMBLY	P562621	Wire, length and colour type to be defined	181
120 WAY SOCKET SURFACE MOUNT PCB CONNECTOR	P562622	Can only be mated with pigtail plug	182
120 WAY PLUG BOARD STRAIGHT PCB CONNECTOR	P562623		183
120 WAY CONNECTOR SAVER	P562624		183

The AXON' 120 way Micro-D connector can be ordered with standard wires and colours (see pages 29 & 30).

For more AXON' 120 way Micro-D connectors references, please contact our engineering department.

► Keying Hardware

**SPECIAL 120 WAY MALE
HARDWARE KIT
WITH KEYWAY: J**

**SPECIAL 120 WAY
FEMALE HARDWARE KIT
WITH KEYWAY: H**

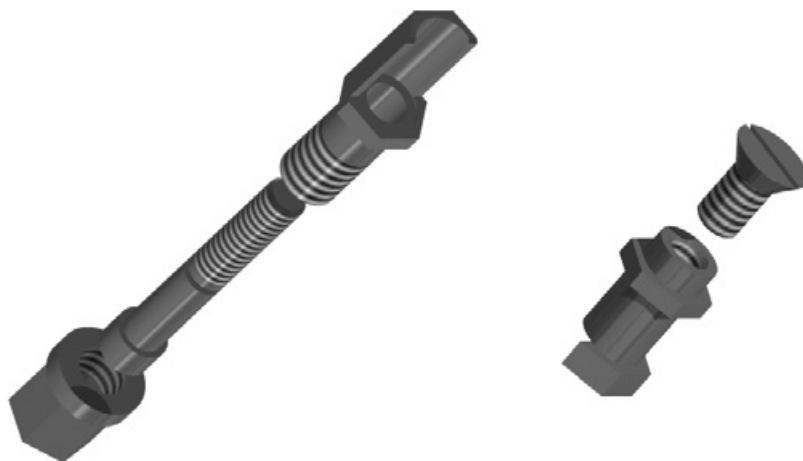

► Electrical & mechanical characteristics

FEATURES	SPECIFICATIONS	TEST METHODS
CURRENT RATING	2.5 A max @ 23°C	EIA-364-70
CONTACT RESISTANCE	8 mΩ max.	EIA-364-06
INSULATION RESISTANCE	5000 MΩ min. @ 500 Vdc	EIA-364-21
DIELECTRIC WITHSTANDING VOLTAGE - SEA LEVEL 0 M - ALTITUDE 21 KM (70,000 FT)	250 V _{Ac} 100 V _{Ac}	EIA-364-20
CONTACT ENGAGING AND SEPARATION FORCE	170 g max. (6 oz) / 14 g min. (0.5 oz)	EIA-364-37
CONNECTOR MATING AND DE-MATING FORCE	283 g (10 oz) X 120	EIA-364-13
CONTACT RETENTION	2.26 kg (5 lbs) for 5 seconds min.	EIA-364-29
DURABILITY	500 mating cycles min.	EIA-364-09
TEMPERATURE RANGE	-55°C / +150°C	
VIBRATION	20 g's - No discontinuity >1μs	EIA-364-28 TEST CONDITION IV
SHOCK	50 g's - No discontinuity >1μs	EIA-364-27 TEST CONDITION E
SALT SPRAY	48 hours	EIA-364-26 TEST CONDITION B
HUMIDITY	Insulation resistance > 1MΩ	EIA-364-31 TEST METHOD IV

► Materials & finish

COMPONENTS	MATERIAL	FINISH
MALE CONTACT (TWIST PIN)	COPPER AND BERYLLIUM COPPER	GOLD PLATING IN ACCORDANCE WITH ASTM-B488, TYPE II, CLASS 1 (1.27μM (0.050") MIN), CODE C OVER NICKEL UNDERPLATE IN ACCORDANCE WITH SAE-AMS-QQ-N-290 CLASS 2 (1.27μM (0.050") TO 3.81μM (0.150"))
FEMALE CONTACT	COPPER ALLOY	
METAL SHELL	ALUMINIUM ALLOY, TYPE 6061	ELECTROLESS NICKEL PLATING IN ACCORDANCE WITH SAE-AMS2404, CLASS 4, .0005 INCH MIN.
INSERTS	LIQUID CRYSTAL POLYMER, 30% LOADED GLASS FIBRE POLYESTER, 94VO, IN ACCORDANCE WITH MIL-M-24519 (200°C)	
HARDWARE	STAINLESS STEEL, 300 SERIES	PASSIVATION IN ACCORDANCE WITH SAE-AMS2700
ENCAPSULANT	EPOXY RESIN	
UNINSULATED WIRE	AWG 2801 SOLID COPPER WIRE	GOLD PLATED IN ACCORDANCE WITH A-A-59551

► 120 way male and female connectors for cable and harnesses

Both male and female connectors can be assembled with various wire sizes in shielded and unshielded forms. High speed variants can also be produced, using controlled impedance shielded twisted pairs which allow data rates of up to 880 Mbps. For space applications, these connectors are assembled in a class 100,000 clean room, and can be terminated with ESA ESCC (European Space Agency) approved wires.



P562620 P562621

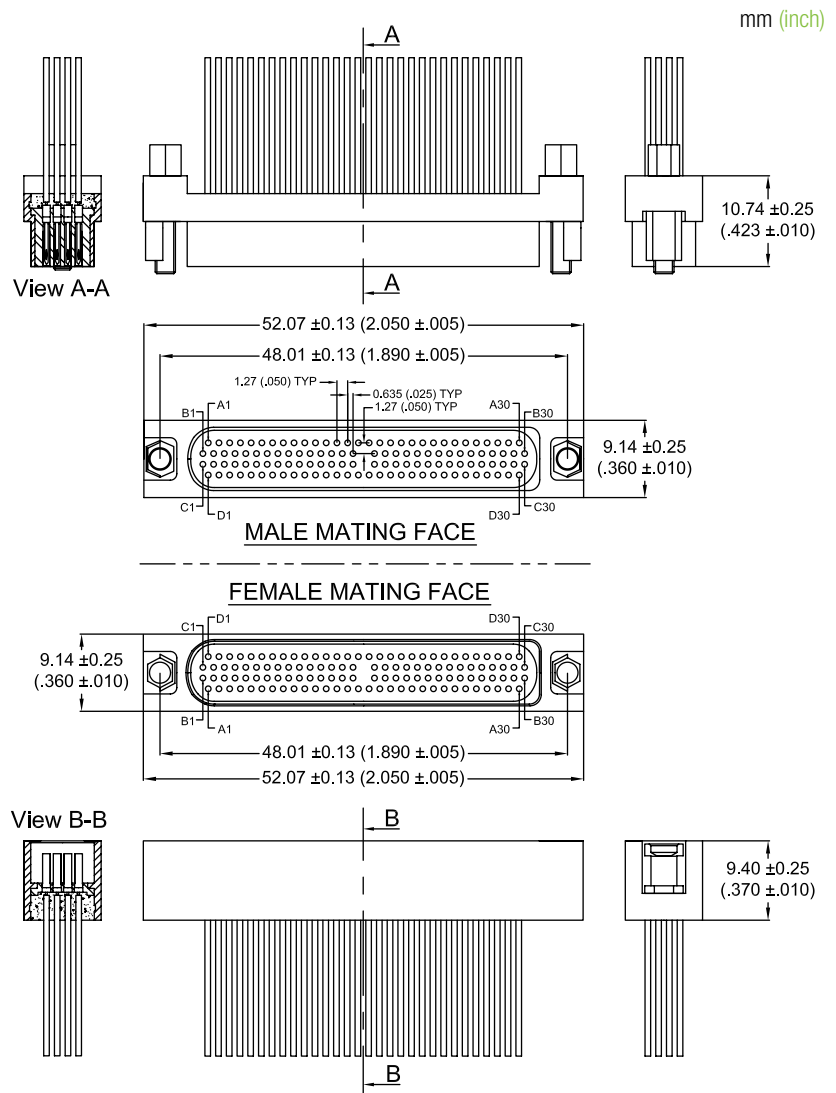

► Surface Mount PCB Card Edge Connectors

Surface Mount (SMT) connectors have two rows of 28 AWG gold plated leads at 0.635 mm (.025") pitch spacing to terminate to PCB's by soldering. Lugs on either side of the connector allow for mechanical clamping onto the PCB.

► AVAILABLE VERSIONS

- Female style to mate with a male pigtail or assembly connector.
- Male and female styles to mate together (this option has a longer shell to retain the keying hardware system).
- Female style for panel mount.

► FEMALE SMT

to mate to a male cable connector.

P562622

mm (inch)

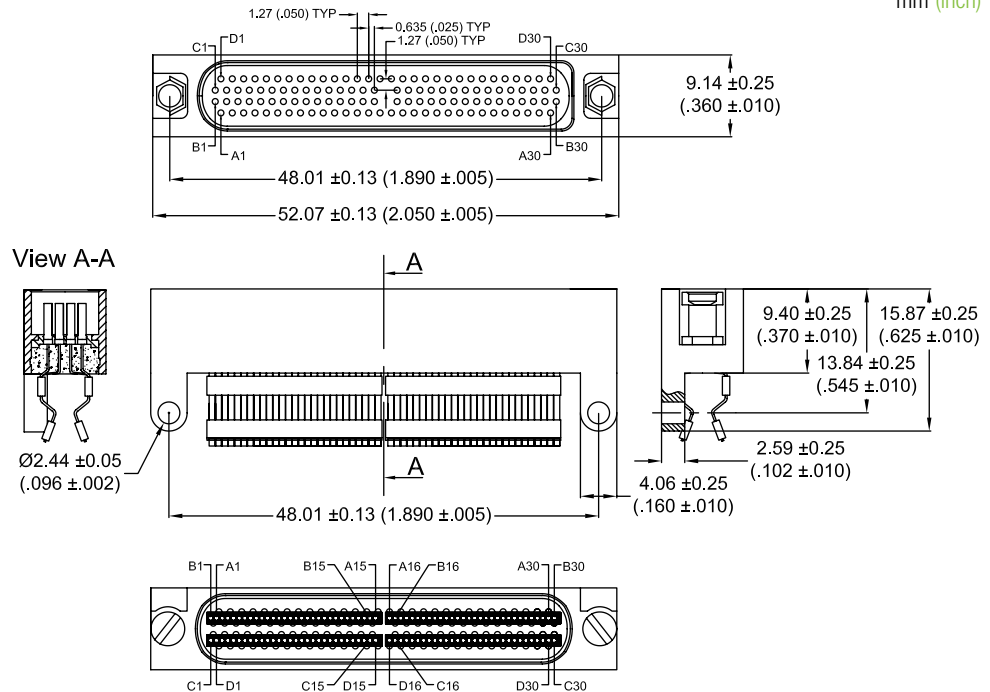

SEE CONTACT LAYOUT ON PCB PAGE 308

► BS Connector

The BS version is similar to the straight PCB connector style of the MIL standard. Available in male version only.

P562623

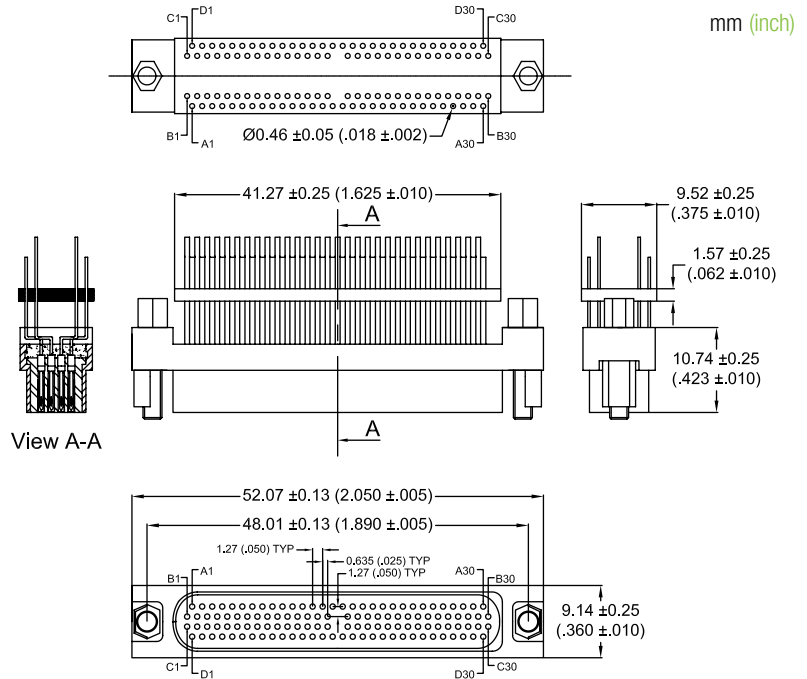

SEE CONTACT LAYOUT ON PCB PAGE 308

► Connector saver

Connector savers have been developed to protect expensive equipment. Typical applications include test equipment and space-grade instruments.

P562624

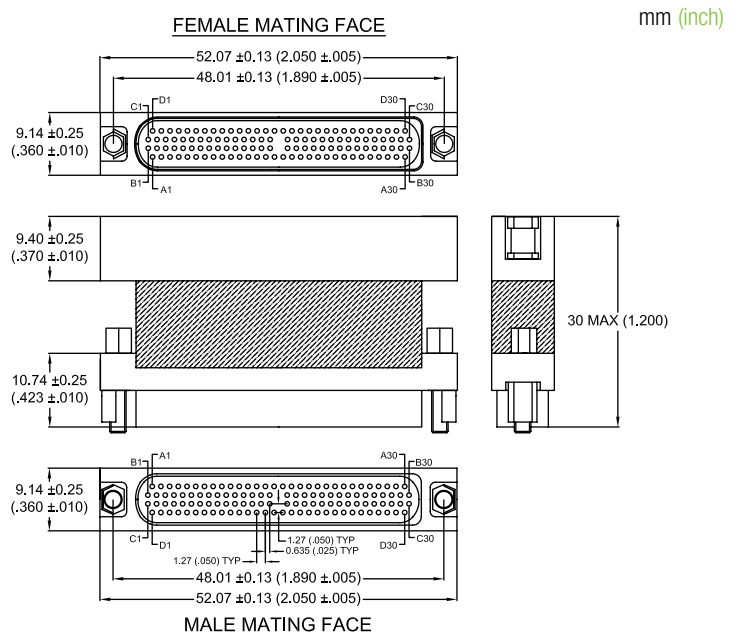

► PCB layout

► FEMALE SMT (SURFACE MOUNT STYLE) CONNECTOR

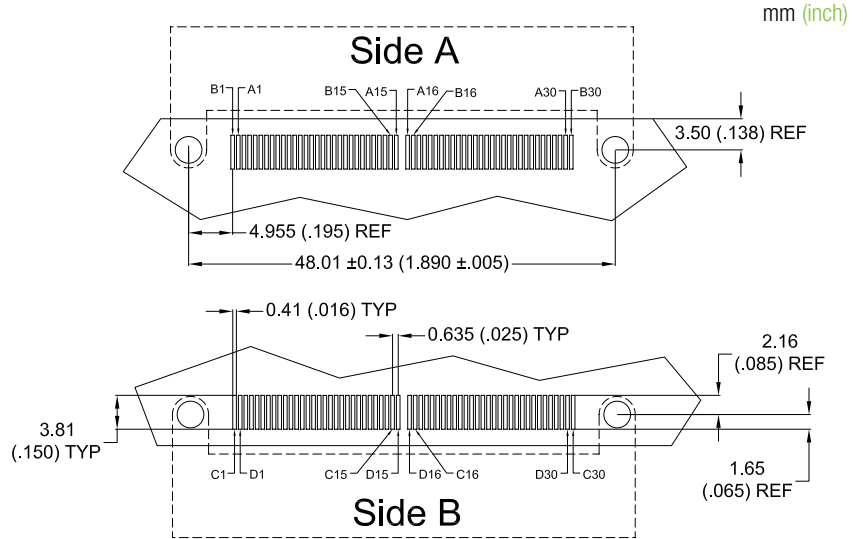

► BS VERSION (MALE ONLY)

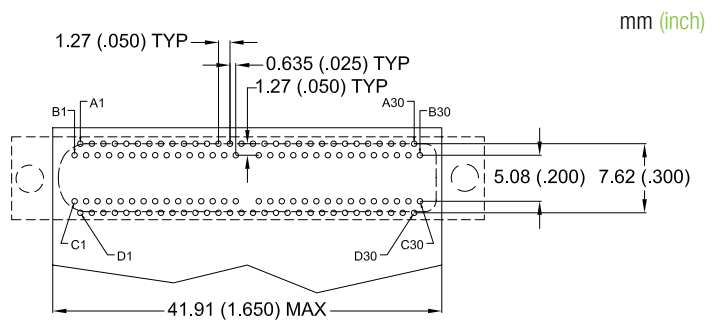

MICRO-D ACCESSORIES

BACKSHELL

- Micro-D EMI-backshell 186
- AXOCLAMP® EMI band termination 189

HARDWARE

- Removable jackscrews 190
- Removable jackposts 192
- Rear panel mount jackposts for pigtailed connectors 193
- Removable jackposts for PCB connectors 194
- Rear panel mount jackposts for PCB connectors 196
- Non-removable hardware 198
- Float mount inserts 199
- U-clip mounting jackscrews 200

MICRO-D & NANO-D ASSEMBLY KIT 201



MICRO-D EMI BACKSHELL

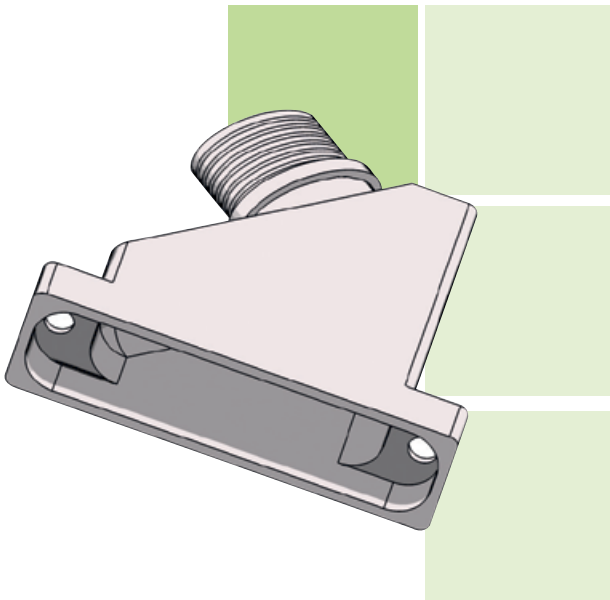

- Micro-D aluminium backshell for EMI termination.
- Supplied with stainless steel hardware.
 - Various entry sizes & shapes.
- Available for standard and micro AXOCLAMP® band termination.
 - Shell size from 9 to 100.

IDENTIFICATION CODE

AXON F 37 05 E 1 C F

SERIES

STYLE TYPE

- U:** Top entry.
- Z:** Side entry.
- F:** 45° entry.

CONNECTOR SIZE

09, 15, 21, 25, 31, 37, 51DR, 51, 69, 100.

ENTRY SIZE

From **01** to **11**,
See page 188 for dimensions.
Other entry sizes available on request.

ENTRY TYPE

- E:** Elliptical.
- BLANK:** Circular.

MATERIAL

1: Aluminium.
Other materials available on request.

PLATING OPTION

- C:** Electroless nickel per SAE-AMS-2404, class 4. (13 µm/.0005 min).
- CHP:** Hi Phos electroless nickel plate to SAE-AMS-2404, class 4 (25.4µm/.001" min), 10% P min.
- Z:** Black zinc nickel over nickel under plate.
- Y:** Yellow chromate over cadmium per QQ-P-416, type II, class 3.

HARDWARE OPTION

- F:** Female jackpost (panel mount jackposts on request)
- BLANK:** Male jackscrew

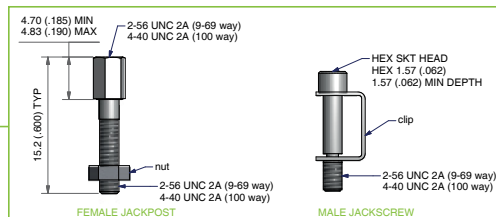

RECOMMENDED TORQUE

- 9 to 69 way jackscrew: 0.28 N.m / 2.5 inch-pounds.
- 100 way jackscrew: 0.51 N.m / 4.5 inch-pounds.
- 9 to 69 way jackpost: 0.35 N.m / 3.1 inch-pounds.
- 100 way jackpost: 0.55 N.m / 4.9 inch-pounds.

DIMENSIONS

Dimensions are in millimetres (inches).

STYLE U: TOP ENTRY

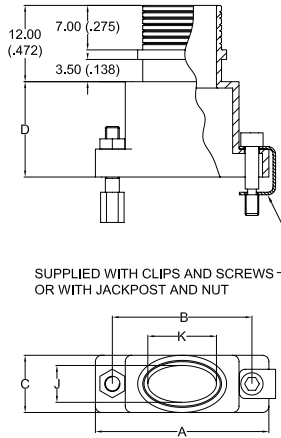

SUPPLIED WITH CLIPS AND SCREWS OR WITH JACKPOST AND NUT

STYLE Z: SIDE ENTRY

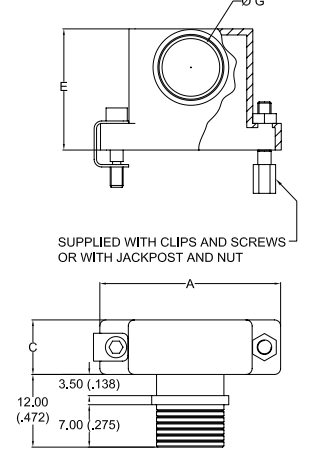

SUPPLIED WITH CLIPS AND SCREWS OR WITH JACKPOST AND NUT

STYLE F: 45° ENTRY

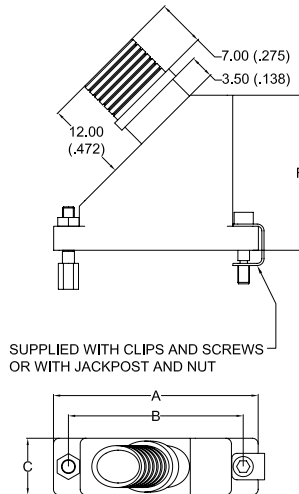

SUPPLIED WITH CLIPS AND SCREWS OR WITH JACKPOST AND NUT

MICRO-D ACCESSORIES

Rectangular Micro-D connectors

SHELL SIZE	A	B	C	D	E	F
9	19.70 .776	14.35 .565	9.00 .354	10.00 .394	15.00 .591	21.00 .827
15	23.40 .921	18.16 .715	9.00 .354	12.00 .472	16.50 .650	23.00 .906
21	27.30 1.075	21.97 .865	9.00 .354	14.00 .551	18.00 .709	25.00 .984
25	29.85 1.175	24.51 .965	9.00 .354	16.00 .630	20.00 .787	27.00 1.063
31	33.70 1.327	28.32 1.115	9.00 .354	17.00 .669	21.00 .827	28.00 1.102
37	37.50 1.476	32.13 1.265	9.00 .354	18.00 .709	22.00 .866	29.00 1.142
51DR	46.30 1.823	41.02 1.615	9.00 .354	19.00 .748	23.00 .906	30.00 1.181
51	36.10 1.421	30.86 1.215	10.00 .394	19.00 .748	23.00 .906	30.00 1.181
69	43.75 1.722	38.48 1.515	10.00 .394	20.00 .787	24.00 .945	31.00 1.220
100	55.00 2.165	45.72 1.800	11.00 .433	21.00 .827	25.00 .984	38.00 1.496

▶ ELLIPTICAL ENTRY

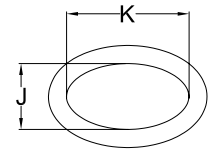

ELLIPTICAL ENTRY
STYLES U AND Z

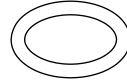

ENTRY SIZE	SHELL SIZE	J	K
04 E	09-100	5.80 .228	7.00 .276
05 E	15-100	5.80 .228	10.80 .425
06 E	25-100	5.80 .228	15.20 .598
07 E	37-100	5.80 .228	20.10 .791
08 E*	51-100	6.80 .268	22.80 .898
09 E	100	7.80 .307	26.00 1.024

ELLIPTICAL ENTRY
STYLE F

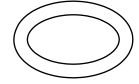

ENTRY SIZE	SHELL SIZE	J	K
04 E	21-100	5.80 .228	7.00 .276
05 E	25-100	5.80 .228	10.80 .425
06 E	37-100	5.80 .228	15.20 .598
07 E*	51-100	6.80 .268	17.70 .697
08 E	100	7.80 .307	20.60 .811
09 E	100	7.80 .307	26.00 1.024

*: **Caution!** Entries for 51DR are the same as for 37 way shells.

▶ CIRCULAR ENTRY

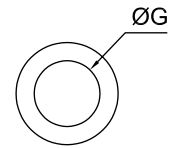

CIRCULAR ENTRY
STYLES U AND F



ENTRY SIZE	SHELL SIZE	G
01	09-100	1.60 .063
02	09-100	3.20 .126
03	09-100	4.80 .189
04*	51-100	6.40 .252
05	100	8.00 .315

CIRCULAR ENTRY
STYLE Z

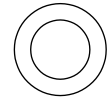

ENTRY SIZE	SHELL SIZE	G
01	09-100	1.60 .063
02	09-100	3.20 .126
03	09-100	4.80 .189
04	09-100	6.40 .252
05	15-100	8.00 .315
06	21-100	9.50 .374
07	25-100	11.10 .437
08	31-100	12.70 .500
09	37-100	14.30 .563
10*	51-100	15.90 .626
11	100	17.50 .689

*: **Caution!** Entries for 51DR are the same as for 37 way shells.

AXOCLAMP® EMI BAND TERMINATION

Material: stainless steel AISI 316.

360° shield termination for connectors can be carried out with a patented metal band called AXOCLAMP®. This ensures the continuity of shielding efficiency at the cable / connector junction.

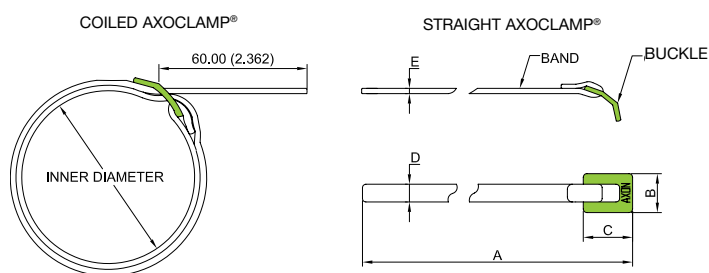

IDENTIFICATION CODE

AXCL	01
AXOCLAMP®	BAND TYPES 01: standard 03: microband double wrapped

The standard version is coiled but straight AXOCLAMP® can be delivered on request (reference example AXCL03D). Minimum quantity: 100 pieces per reference.

DIMENSIONS

Dimensions are in millimetres (inches).

SPECIFICATIONS	AXOCLAMP® STANDARD	AXOCLAMP® MICROBAND
REFERENCE	AX CL 01	AX CL 03
DIMENSION A	375 (14.764)	200 (7.874)
DIMENSION B	9 (.364)	5.2 (.205)
DIMENSION C	10 (.394)	5.5 (.217)
DIMENSION D	5.9 (.232)	3 (.118)
DIMENSION E	0.5 (.020)	0.35 (.014)
MINIMUM DIAMETER*	10 (.394)	5 (.197)
MAXIMUM DIAMETER*	40 (1.575)	15 (.591)

*: Minimum and maximum diameter of the rear funnel on which the AXOCLAMP® can be mounted. For other dimensions, please consult us.

BANDING TOOLS

	MANUAL HAND TOOL	CLAMPING VALUES	PNEUMATIC CLAMPING TOOL	RECOMMENDED BANDING VALUES*	CALIBRATION DEVICE
AXOCLAMP® AX CL 01	A 40199	100-180 LBS	A 35199	160	A 50099
AXOCLAMP® AX CL 03	A 30199	60-100 LBS	A 35599	90	A 50099

*: Banding values are given for information only.

HARDWARE

▶ Removable jackscrews according to MIL-DTL-83513/05

FOR PIGTAIL & SOLDER CUP CONNECTORS ONLY.

- 2 sizes of hardware: one version for shell sizes from 9 to 69 ways and another version for the 100-way shell size.
- 1 kit consists of 2 screws and 2 e-rings.
- Hex socket head or slot head.
- Material: passivated 300 series stainless steel.

Note

1st line: kit part number (to be used for ordering).

2nd line: military specification number.

3rd line: hardware code for pigtail connector.

Dimensions are given in millimetres (inches).

9-69 WAY HARDWARE

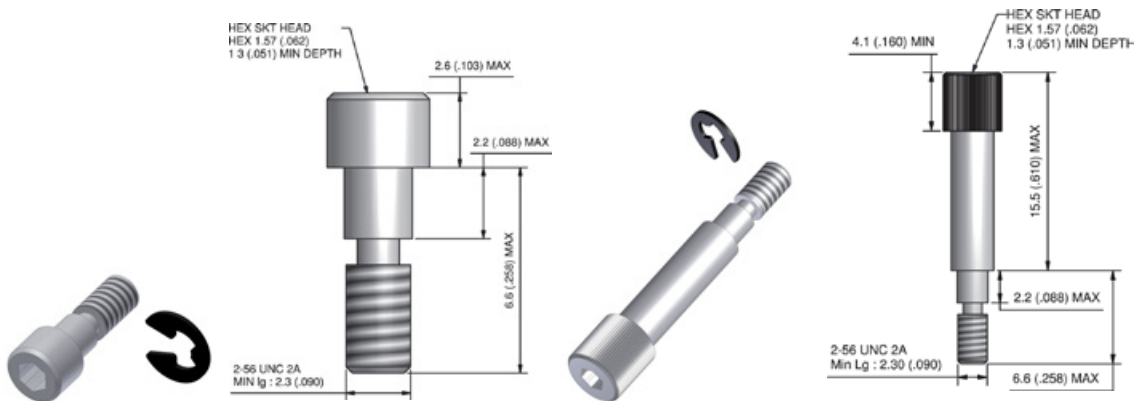

KIT PART NUMBER: **MDAHM502**

According to M83513/05-02

Hardware code: **M**

KIT PART NUMBER: **MDAHM503**

According to M83513/05-03

Hardware code: **N**

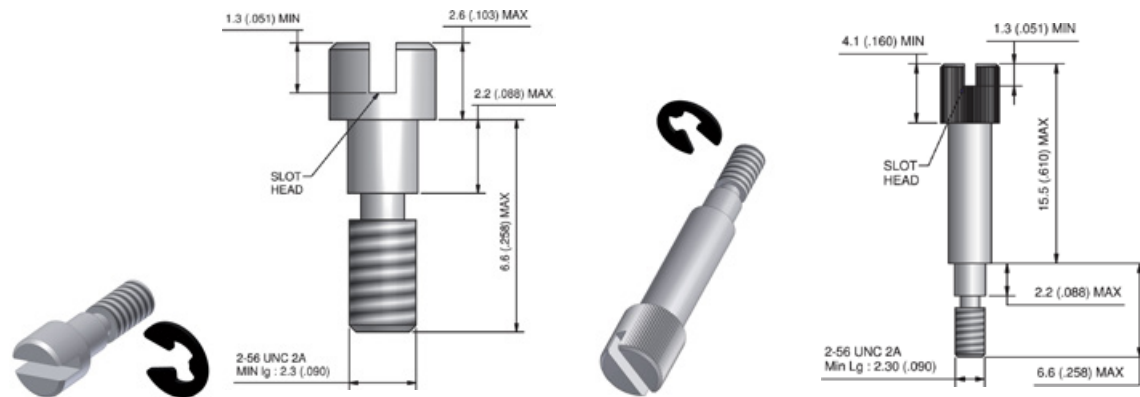

KIT PART NUMBER: **MDAHM505**

According to M83513/05-05

Hardware code: **S**

KIT PART NUMBER: **MDAHM506**

According to M83513/05-06

Hardware code: **T**

100 WAY HARDWARE

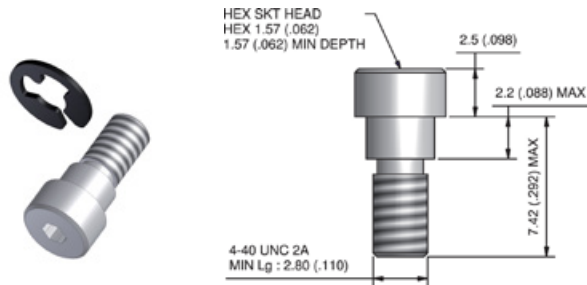

KIT PART NUMBER: **MDAHM512**
According to M83513/05-12
Hardware code: **M**

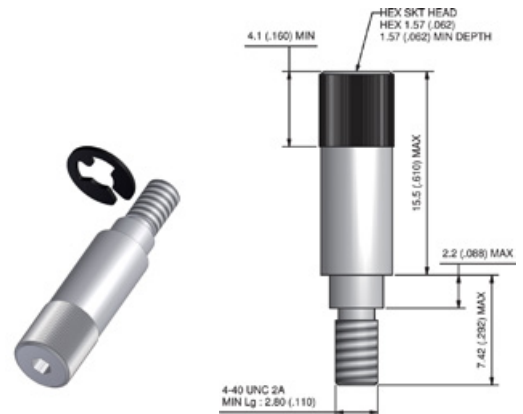

KIT PART NUMBER: **MDAHM513**
According to M83513/05-13
Hardware code: **N**

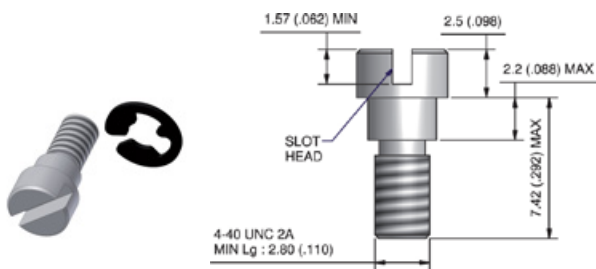

KIT PART NUMBER: **MDAHM515**
According to M83513/05-15
Hardware code: **S**

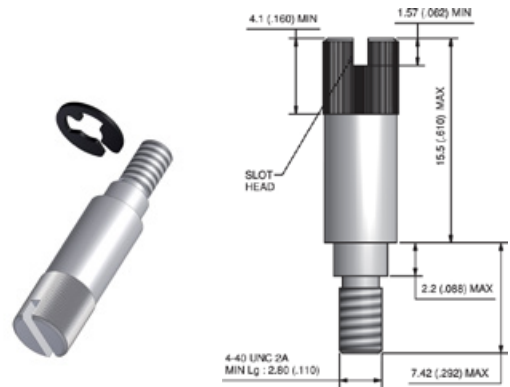

KIT PART NUMBER: **MDAHM516**
According to M83513/05-16
Hardware code: **T**

► RECOMMENDED TORQUE

- 9 to 69 way jackscrew: 0.28 N.m / 2.5 inch-pounds.
- 100 way jackscrew: 0.51 N.m / 4.5 inch-pounds.

HARDWARE

▶ Removable jackposts according to MIL-DTL-83513/05

- 2 sizes of hardware: one version for shell sizes from 9 to 69 ways and another version for the 100-way shell size.
- 1 kit consists of 2 posts, 2 washers and 2 nuts.
- Material: passivated 300 series stainless steel.

Note
1st line: kit part number (to be used for ordering).
2nd line: military specification number.
3rd line: Hardware code.
Dimensions are given in millimetres (inches).

9-69 WAY HARDWARE

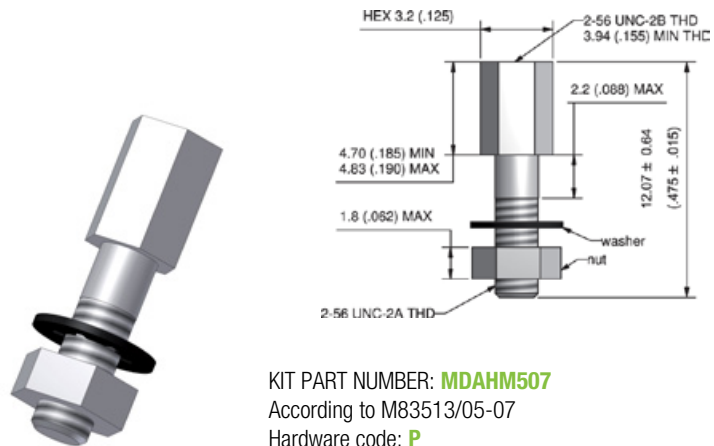

100 WAY HARDWARE

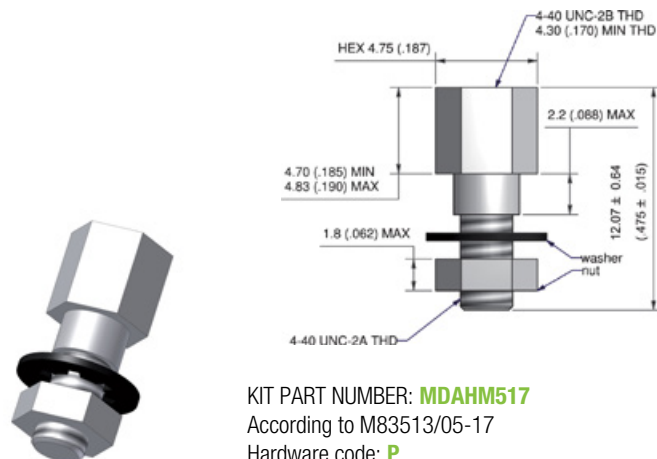

▶ Rear panel mount jackposts for pigtails

- 2 sizes of hardware: one version for all shell sizes for 9 to 69 way and another version for the 100 way shell size.
- 1 kit consists of 2 posts, 2 washers and 2 nuts.
- Material: passivated 300 series stainless steel.

Dimensions are given in millimetres (inches).

HARDWARE CODE	Px	P1	P2	P3	P4	P5
PANEL THICKNESS -0.0 /+0.2 (-.000 /+.008)	mm	0.8	1.2	1.6	2	2.4
	inch	.031	.047	.062	.079	.094
KIT PART NUMBER	9-69 way	MDAHMP01	MDAHMP02	MDAHMP03	MDAHMP04	MDAHMP05
	100 way	MDAHMP11	MDAHMP12	MDAHMP13	MDAHMP14	MDAHMP15
DIM. A	mm	0.7	1.1	1.5	1.9	2.3
	inch	.028	.043	.059	.075	.091

9-69 WAY HARDWARE

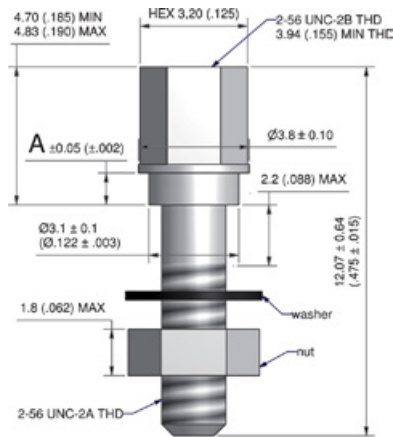

100 WAY HARDWARE

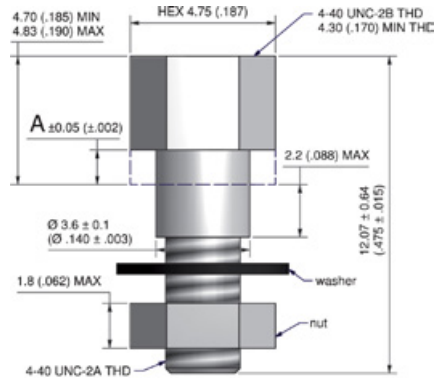

▶ RECOMMENDED TORQUE

- 9 to 69 way jackpost: 0.35 N.m / 3.1 inch-pounds.
- 100 way jackpost: 0.55 N.m / 4.9 inch-pounds.

HARDWARE

▶ Removable jackposts for PCB connectors

- 2 sizes of hardware: one version for shell sizes from 9 to 69 ways and another version for the 100-way shell size.
- Hardware kit depending on the PCB type (see table below).
- 1 kit consists of 2 posts.
- Material: passivated 300 series stainless steel.

Dimensions are given in millimetres (inches).

HARDWARE CODE	P		
KIT PART NUMBER	9-69 way	BS or BR	MDAHM507SPCB
		CBR or CBP	MDAHM507SM2PCB
	100 way	BS, BR or CBR 0.075"	MDAHM517SPCB
		CBR 0.100"	MDAHM517SLPCB

9-69 WAY HARDWARE

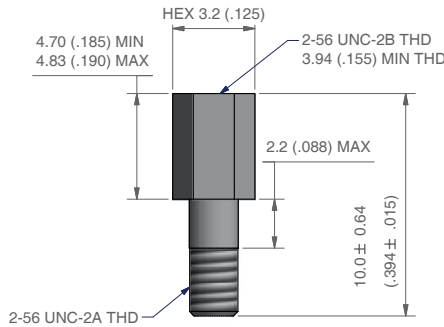

KIT PART NUMBER: **MDAHM507SPCB**

According to M83513/05-07

Hardware code: **P**

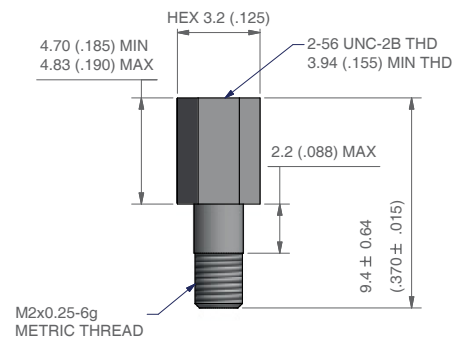

KIT PART NUMBER: **MDAHM507SM2PCB**

According to M83513/05-07

Hardware code: **P**

100 WAY HARDWARE

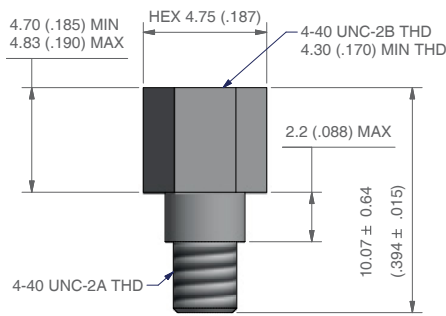

KIT PART NUMBER: **MDAHM517SPCB**
 According to M83513/05-17
 Hardware code: **P**

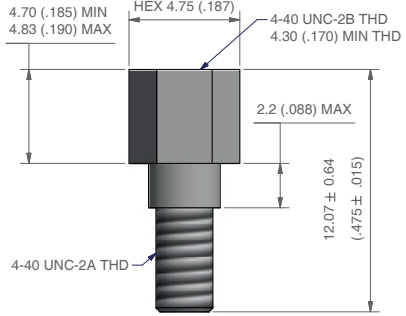

KIT PART NUMBER: **MDAHM517SLPCB**
 According to M83513/05-17
 Hardware code: **P**

MICRO-D
ACCESSORIES
Rectangular
Micro-D connectors

► RECOMMENDED TORQUE

- 9 to 69 way jackpost: 0.35 N.m / 3.1 inch-pounds.
- 100 way jackpost: 0.55 N.m / 4.9 inch-pounds.

Micro-D accessories

HARDWARE

► Rear panel mount jackposts for PCB connectors

- 2 sizes of hardware: one version for shell sizes from 9 to 69 ways and another version for the 100-way shell size.
- Hardware kit depending on the PCB type (see table below).
- 1 kit consists of 2 posts.
- Material: passivated 300 series stainless steel.

Dimensions are given in millimetres (inches).

HARDWARE CODE	Px	P1	P2	P3	P4	P5
PANEL THICKNESS -0.0 / +0.2 (-.000 / +.008)	mm	0.8	1.2	1.6	2	2.4
	inch	.031	.047	.062	.079	.094
9-69 way	BS or BR	MDAHMSP01	MDAHMSP02	MDAHMSP03	MDAHMSP04	MDAHMSP05
	CBR or CBP	MDAHMSM2P01	MDAHMSM2P02	MDAHMSM2P03	MDAHMSM2P04	MDAHMSM2P05
100 way	BS, BR or CBR 0.075"	MDAHMSP11	MDAHMSP12	MDAHMSP13	MDAHMSP14	MDAHMSP15
	CBR 0.100"	MDAHMSLP11	MDAHMSLP12	MDAHMSLP13	MDAHMSLP14	MDAHMSLP15
DIMENSIONS A	mm	0.7	1.1	1.5	1.9	2.3
	inch	.028	.043	.059	.075	.091

9-69 WAY HARDWARE

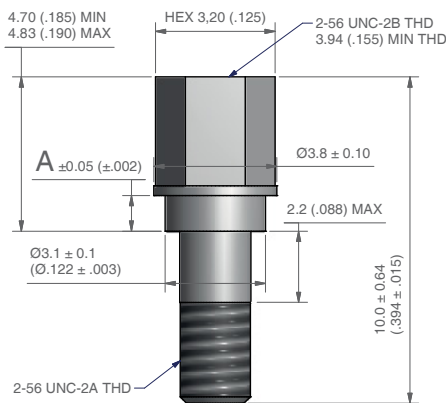

KIT PART NUMBER: **MDAHMSP0x**
Hardware code: **Px**

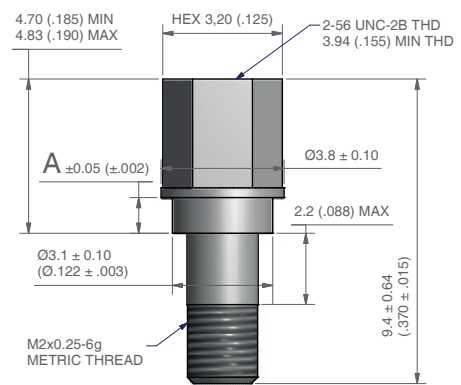

KIT PART NUMBER: **MDAHMSM2P0x**
Hardware code: **Px**

100 WAY HARDWARE

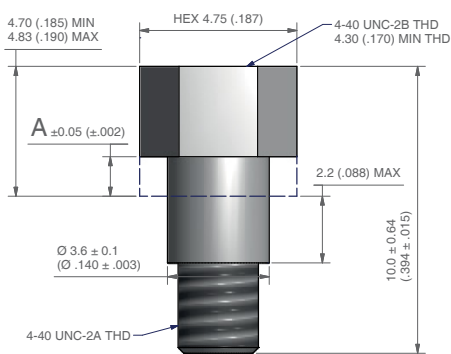

KIT PART NUMBER: **MDAHMSP1x**
Hardware code: **Px**

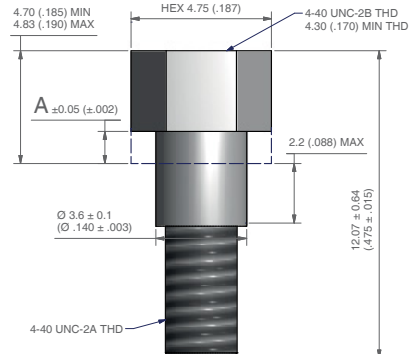

KIT PART NUMBER: **MDAHMSLP1x**
Hardware code: **Px**

MICRO-D
ACCESSORIES

Rectangular
Micro-D connectors

➤ RECOMMENDED TORQUE

- 9 to 69 way jackpost: 0.35 N.m / 3.1 inch-pounds.
- 100 way jackpost: 0.55 N.m / 4.9 inch-pounds.

Caution: When PCB connectors are mounted on panels, the assembly can potentially be hyperstatic (producing stresses and strains) if the printed circuit board is mechanically linked to the panel.

HARDWARE

► Non removable hardware

FOR PIGTAIL & SOLDER CUP CONNECTORS ONLY.

- Hardware is factory installed.
- Cannot be supplied in kit form.
- Material: passivated 300 series stainless steel.

9-69 WAY HARDWARE

100 WAY HARDWARE

LONG JACKSCREW (SLOT HEAD)

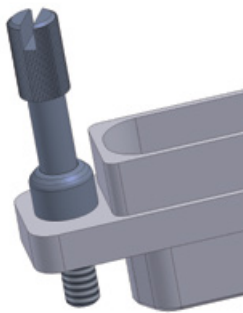

HARDWARE CODE: K

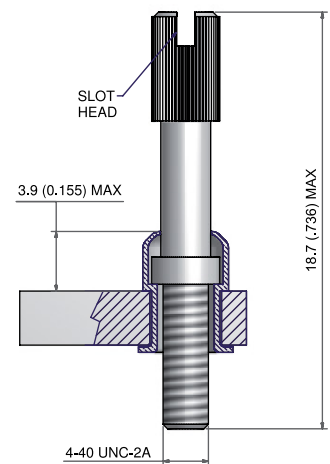
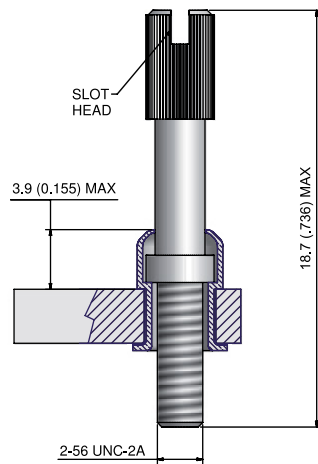

SHORT JACKSCREW (HEX SOCKET HEAD)

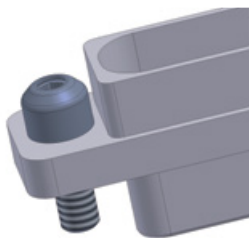

HARDWARE CODE: L

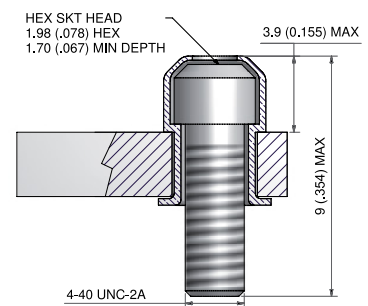
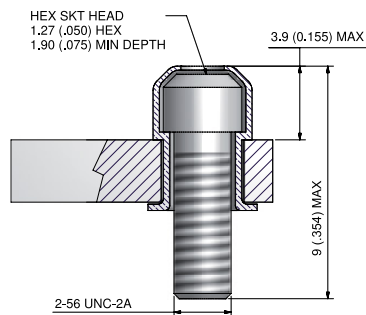

▶ Float mount inserts

TO BE USED TO FIX CONNECTORS ON A SYSTEM WITH SCREWS.
FOR PIGTAIL & SOLDER CUP CONNECTORS ONLY.

- Hardware is factory installed.
- Cannot be supplied in kit form.
- Material: passivated 300 series stainless steel.

9-69 WAY HARDWARE

100 WAY HARDWARE

FRONT PANEL MOUNT

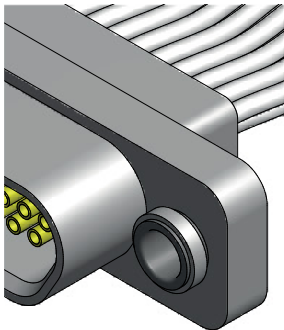

HARDWARE CODE: F

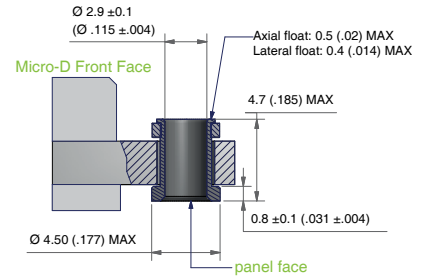
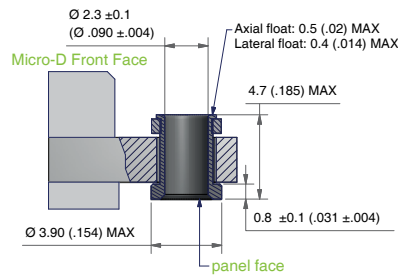

REAR PANEL MOUNT

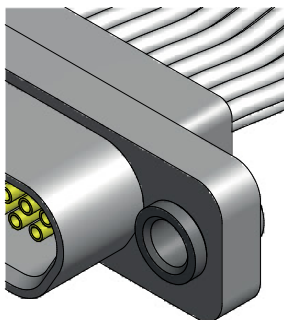

HARDWARE CODE: FR

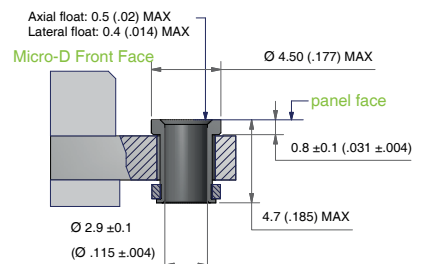
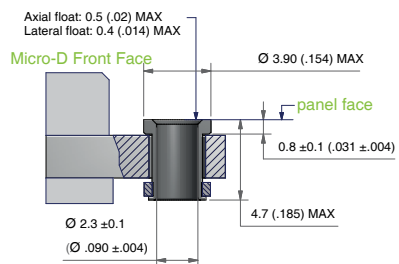

HARDWARE

▶ U-clip mounting jackscrews

FOR PIGTAIL & SOLDER CUP CONNECTOR ONLY.

- 2 sizes of hardware: one version for shell sizes from 9 to 69 ways and another version for the 100-way shell size.
- 1 kit consists of 2 screws and 2 U-clips.
- Hex socket head or slot head.
- Material: passivated 300 series stainless steel.

Note

1st line: kit part number (to be used for ordering).

2nd line: Hardware code for pigtail connector.

Dimensions are given in millimetres (inches).

9-69 WAY HARDWARE

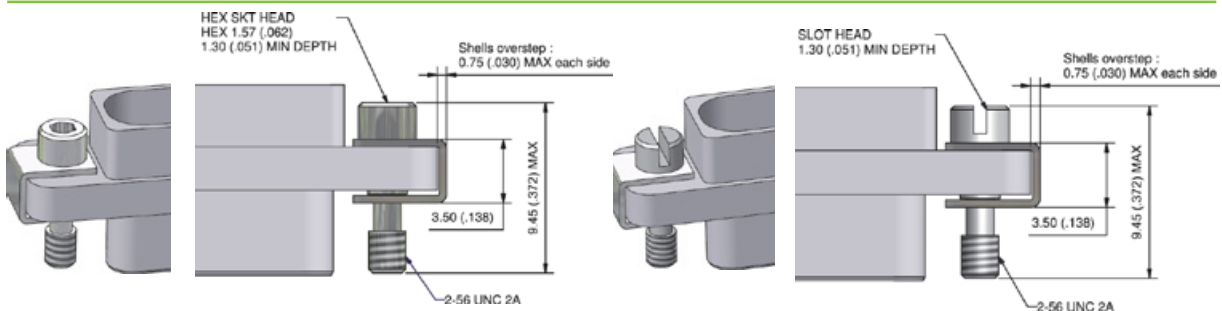

KIT PART NUMBER: **MDAHM008**

Hardware code: **C**

KIT PART NUMBER: **MDAHM009**

Hardware code: **D**

100 WAY HARDWARE

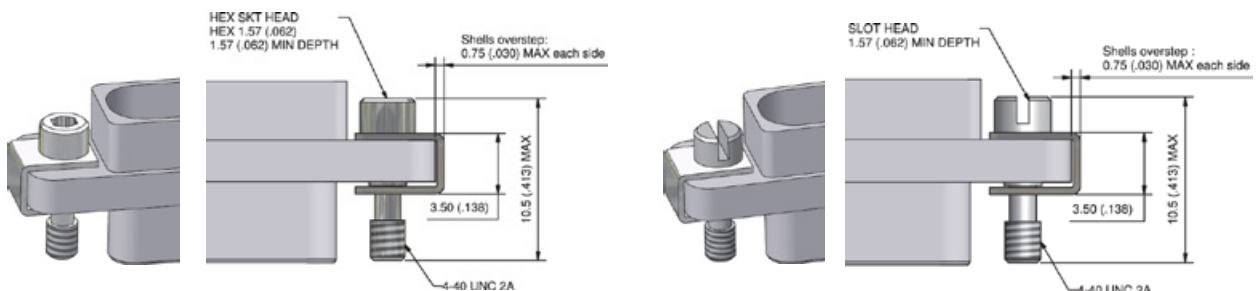

KIT PART NUMBER: **MDAHM018**

Hardware code: **C**

KIT PART NUMBER: **MDAHM019**

Hardware code: **D**

▶ RECOMMENDED TORQUE

- 9 to 69 way jackscrew: 0.28 N.m / 2.5 inch-pounds.
- 100 way jackscrew: 0.51 N.m / 4.5 inch-pounds.

MICRO-D & NANO-D ASSEMBLY KIT

Installation, maintenance and general handling of miniature connectors integrated within your system requires specific tooling and operating procedures. AXON' offers 2 toolboxes with all the proper tools and instructions on how to safely handle Micro-D & Nano-D connectors. These toolboxes greatly simplify connector handling, thus aiding correct installation. This will guarantee the connector's performance in terms of signal and power transmission, and of product life.

► Characteristics

- Assembly kits consisting of universal tools for the assembly of rectangular Micro-D & Nano-D connectors and the majority of custom-designed connectors.
- Easy-to-mount components in any situation.
- Both toolboxes delivered with mounting / dismounting procedures: short instructions and a demonstration video (CD).
- Dedicated tooling with torque values as defined in the MIL-DTL-83513 & MIL-DTL-32139 standards: optimisation of fastener / hardware performance and enhanced connection reliability.
- Each assembly kit is equipped with a screwdriver with dedicated torque range. Our whole line of miniature connectors is covered by both screwdrivers. See table hereafter.



▲ MICRO-D ASSEMBLY KIT COMPACT AND LIGHTWEIGHT PACKAGE:
DIMENSIONS 270 x 230 x 80 mm (10.6" x 9" x 3.1") FOR A WEIGHT OF 750g (1.7 lb)

ITEM	MICRO-D KIT (P541268) for Micro-D connectors (9 to 120 way)	MICRO-D / NANO-D KIT (P536692) for Nano-D connectors & Micro-D connectors (9 to 69 way)
1	Torque screwdriver	Torque screwdriver
2	3/16" spanner	0.050" bit for hex screw
3	5/32" spanner	1/16" bit for hex screw
4	1/8" spanner	5/32" spanner
5	Bit for slotted head screw	1/8" spanner
6	0.050" bit for hex screw	1/8" Socket
7	1/16" bit for hex screw	Bit for slotted head screw
8	5/64" bit for hex screw	Insertion tool
9	1/8" socket	Socket adaptor
10	3/16" socket	
11	100-way de-mating tool	
12	Socket adaptor	
13	Assembly tool	